

MERCEDES-BENZ OF
NORTH AMERICA, INC.
SERVICE DIVISION

MERCEDES-BENZ OF
CANADA, LTD.
SERVICE DEPARTMENT

SERVICE MANAGEMENT
Technical Product Training



GASOLINE FUEL INJECTION, ELECTRONICALLY CONTROLLED.

Electronic, a frightening thought to some of us and indeed, electronic technology can get very complex. Yet, the way the system has been applied to our passenger models is just the opposite.

It was not long ago that we spoke elatedly about the efficiency and reliability of the "mechanically controlled gasoline injection system," a unique feature on our highline and sports cars for many years. To improve on a well proven system like this, is not an easy task. But, with confidence, we can credit the electronic injection system with highest efficiency under all operating conditions; a maintenance reduction, easy adaptability to different models, and still at a cost savings atop of all those features.

The following pages will familiarize you with the function of electronic injection system.

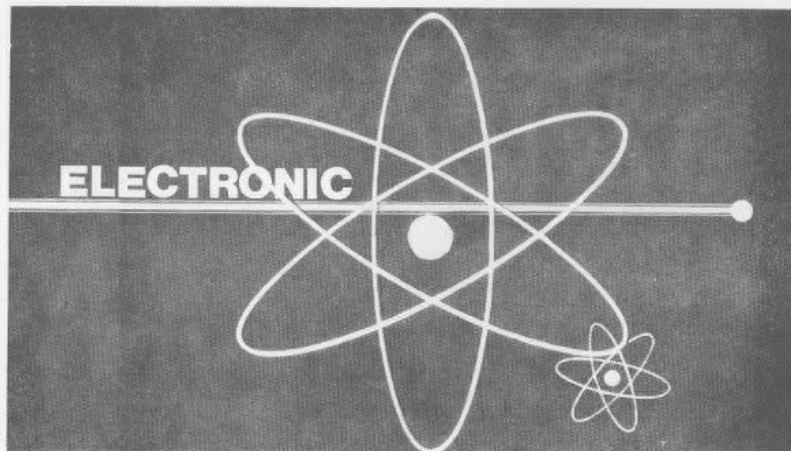

INDEX

A. Fuel Flow Circuit

1. Fuel Pump
2. Fuel Filter
3. Fuel Pressure Regulator
4. Fuel Damper
5. Cold Start System

B. Electronic Control System

1. Pressure Sensor
2. Impulse Sending Unit
3. Throttle Valve Switch
4. Water Temperature Sensor
and Air Slide Valve
5. Air Temperature Sensor
6. Electronic Control Unit

C. Maintenance

1. Fuel Line Service
2. Fuel Filter Care
3. Idle Adjustment
4. Fuel Pressure Adjustment
5. Throttle Switch Adjustment

D. Diagnostic Hints

1. Test Procedure with Bosch EFAW 228
2. Wiring Diagram

A. FUEL FLOW CIRCUIT (Fig. 1)

An ELECTRIC PUMP (item 1) supplies fuel to the circuit and a PRESSURE REGULATOR (item 2) located in the fuel loop, keeps the pressure at 28.4 psi. The excess fuel flows through a DAMPER (item 3) back to the tank.

The inline FUEL FILTER (item 4) prevents dirt from reaching the INJECTION VALVES (item 5).

Fuel pressure is also fed to the COLD START VALVE (item 6) which is utilized at a water temperature below 95°F.

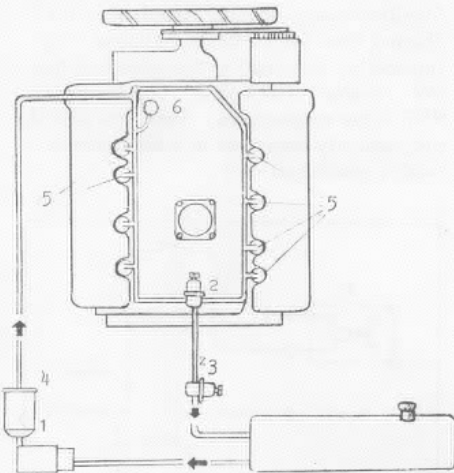

FIG. 1

1. The FUEL PUMP (Fig. 2) supplies approx. 60% more fuel than needed. This keeps the fuel lines relatively cool and chances of vapor locks are therefore minimal.

Should there occur a restriction in the fuel circuit, a relief valve (item 1) will open and fuel flows back to the tank. The same valve also keeps a residual pressure in the circuit when the engine is shutoff.

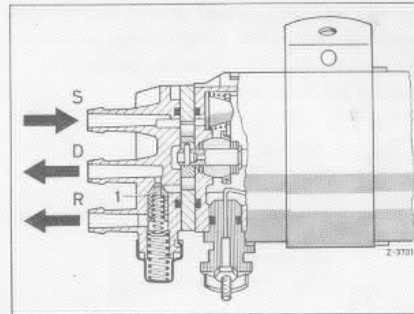

FIG. 2

- | | |
|------------------------------------|-------------|
| 1. CHECK AND PRESSURE RELIEF VALVE | S SUCTION |
| | D DISCHARGE |
| | R RETURN |

When turning on the ignition, the current supply to the fuel pump is interrupted after one second. This SAFETY CIRCUIT (Fig. 3) prevents a potential flooding of a cylinder. As soon as the engine is cranked or started, the fuel pump is automatically turned on again and remains running as long as the engine does.

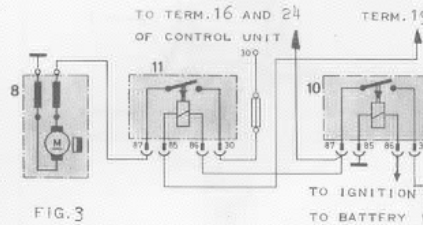

FIG. 3

8. FUEL PUMP 11. PUMP RELAY 10. MAIN RELAY

2. The FUEL FILTER (Fig.4) consists of a paper element and a metal casing. It can not be cleaned and should be replaced every 30,000 miles. More frequent replacements may be necessary under unfavorable conditions.

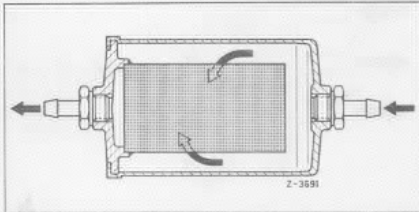

FIG. 4

3. The fuel pump pressure which is also the injection pressure, is limited to 28.4 psi by the PRESSURE REGULATOR (Fig.5). This pressure must be kept at the specified value because the whole electronic system is programmed to this pressure. Corrections can be made at the adjustment screw.

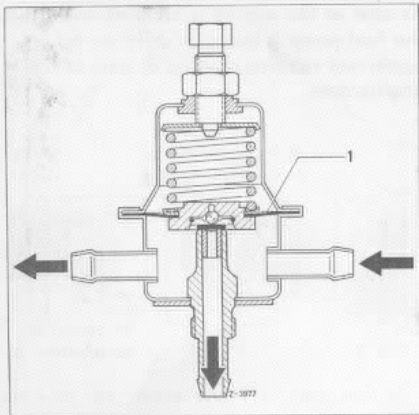

FIG. 5

4. A fuel noise DAMPER which looks similar to the pressure regulator is installed in the return line. It is not adjustable.

5. Below a coolant temperature of 95 F, a COLD START SYSTEM (Fig. 6) is activated while cranking the engine.

A Thermo Time Switch (item 3), located in the coolant circuit, senses water temperature. Below 95°F the "W" terminal of the switch provides ground for the relay (item 1). This completes the control circuit of the relay. Now, when the engine is started, the relay will close and current from the fuse will energize the cold start valve (item 2). As long as the valve is energized, fuel is injected into the intake manifold at a pressure of 28.4 psi.

Simultaneously, the "G" terminal of the Thermo Time Switch heats a bimetal strip internally, interrupting the ground of the "W" terminal after approx. one second at 95 F water temperature. That time period progressively lengthens to a maximum of twelve seconds at -4°F.

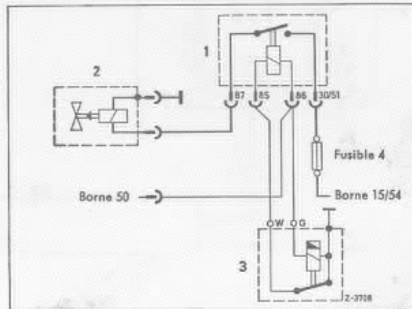

FIG. 6

1. RELAY 2. COLD START VALVE 3. THERMO TIME SWITCH

Fig. 8 shows a cutaway view of the cold start valve.

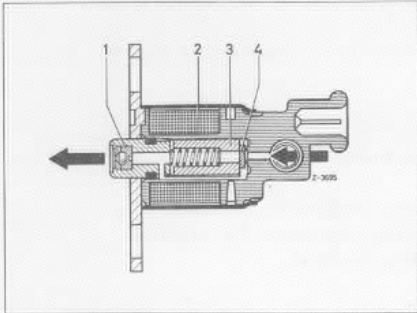

FIG.8

- | | |
|------------------|-------------|
| 1. SWIRL NOZZLE | 3. ARMATURE |
| 2. MAGNETIC COIL | 4. SEAL |

NOTES

B. ELECTRONIC CONTROL SYSTEM.

The fuel flow system works independent of the electronic sensors and switches, except for the fuel pump safety circuit which is controlled by the control unit.

The concept of electronically controlled fuel injection is illustrated in Fig. 9 in a simple but accurate way.

Five different sensors located throughout the engine record all operating conditions of the engine, ambient temperature and barometric pressure.

This information is fed into the control unit where the data is processed. The output data which consists of electrical current impulses opens the injection valves at the precise time and control the opening duration.

The function of each individual sensor is described in detail in the following pages.

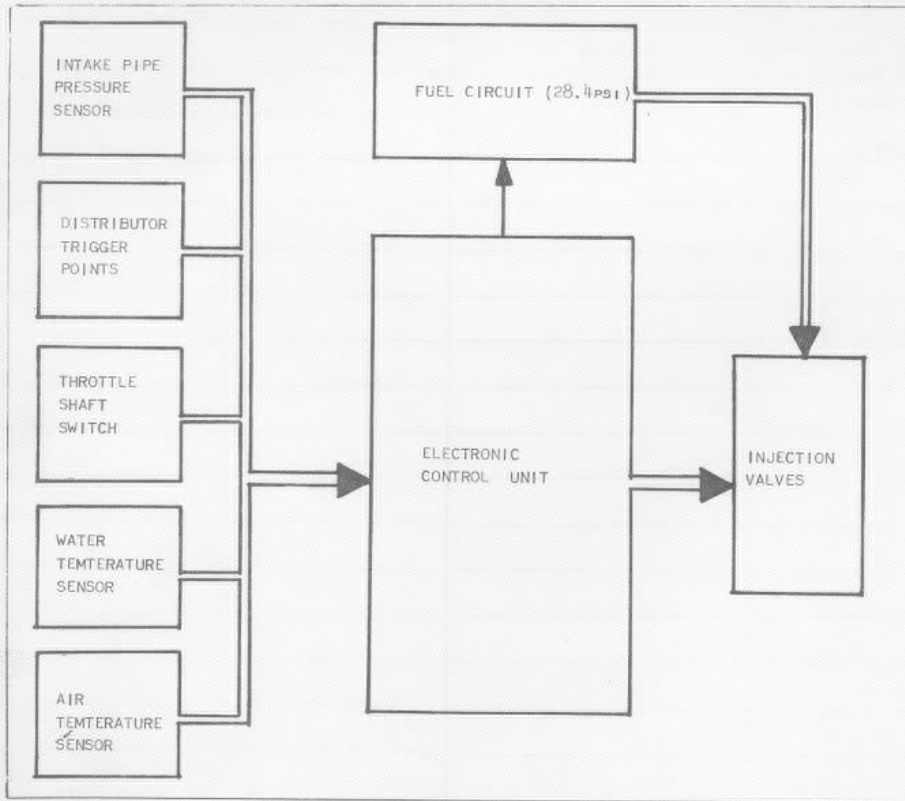

FIG. 9

1. The intake pipe PRESSURE SENSOR (Fig. 10) records the most important information - the engine load.

Therefore, it determines to a large extent, the duration of valve opening.

The sensor is connected to the intake manifold and reacts to any vacuum changes. If for example, a high vacuum prevails in the chamber (item 9), the two evacuated cells (item 4) expand and push the armature (item 6) towards the right or further out of the magnetic field, produced by the coil (item 5). This sends a weak impulse to the control unit, in turn, keeping the valves open for only a short amount of time. As a result, a small amount of fuel is injected.

With low or no vacuum in the vacuum chamber, the cells contract and the armature moves deeper into the magnetic field sending a strong impulse to the control unit. That means the valves are kept open longer and more fuel is injected.

Atmospheric pressure changes in the pressure chamber (item 10), also directly effect the movement of the armature. This means that the engine operates at its maximum efficiency at any altitude.

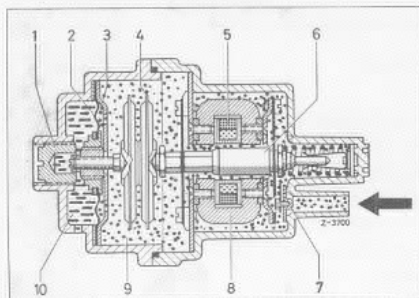

FIG. 10

1. FULL LOAD STOP	6. ARMATURE
2. DIAPHRAGM	8. CORE
4. EVAC. CELLS	9. VACUUM CHAMBER
5. COIL	10. ATMOSPHERIC CHAMBER
	VACUUM
	ATMOSPHERE

The intake pipe pressure sensor (Fig. 11) on engine type M117 is on the operating principle close to that of the M116, but without a full load enrichment possibility. Full load enrichment is now controlled by a contact in the throttle switch.

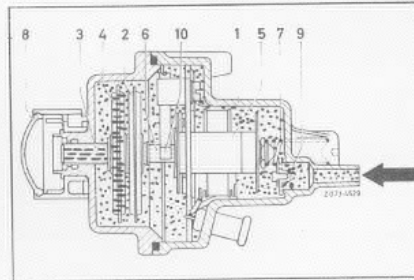

FIG. 11

2. The beginning of injection is signaled to the control unit by the IMPULSE SENDING UNIT (Fig. 12), or also referred to as distributor trigger points.

Four sets of contact points mounted on one metal plate form one unit which is located at the lower part of the distributor.

Each set of points is connected to one valve group via the control unit. When one set closes, two injection valves are opened.

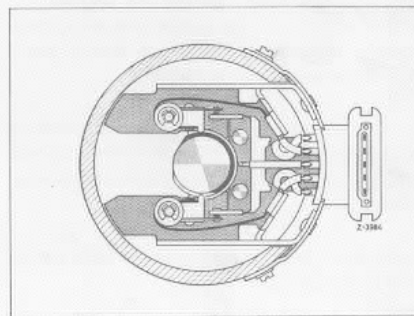

FIG. 12

Fig. 13 shows the injection valve groups.

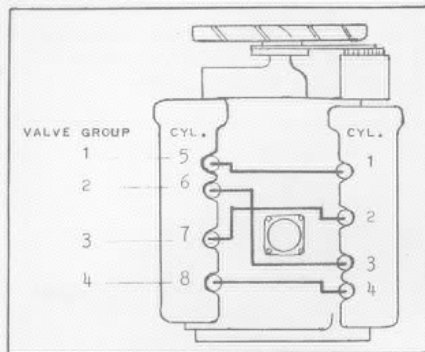

FIG.13

3. The THROTTLE VALVE SWITCH (Fig. 14) which is attached to the throttle shaft, has several functions.

During acceleration, a metal strip slides over contact segments (item 1) signaling to the control unit to keep the injection valves open longer. When decelerating, a contact switch (item 2) breaks the circuit and makes further enrichment impossible.

Simultaneously, during coasting, another contact switch (item 3) closes, sending an impulse to the control unit to keep the injection valves shut. Before the engine reaches idle rpm, the valves are energized again by the control unit even though the contact switch remains closed.

The fuel amount for idle can be adjusted by turning the rheostatic switch on the control unit, but only if the shutoff contact switch is closed.

The contact switch must open as soon as the throttle is opened.

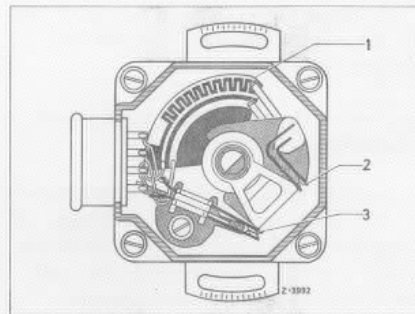

FIG.14

The Throttle Switch of the M117 (Fig. 15) works identical, but has one additional sliding contact which controls the full load enrichment.

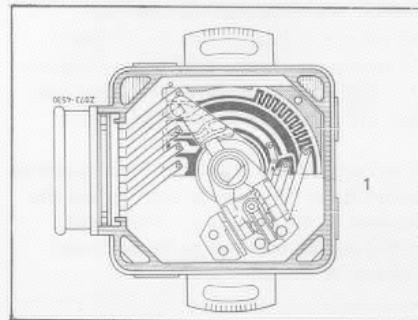

FIG.15

1. FULL LOAD CONTACT

4. A WATER TEMPERATURE SENSOR (Fig. 16) is located in the coolant circuit. Its function is to provide a fuel enrichment up to a water temperature of 150°F.. The ohmic resistance value of the sensor lessens progressively with decreasing water temperature.

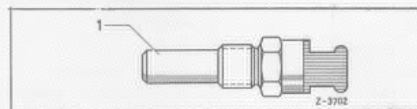

FIG.16

4a. While the water temperature sensor initiates the extra fuel required for a smooth warm-up of the engine, an ADDITIONAL AIR SLIDE VALVE (Fig. 17) provides the necessary air up to a water temperature of 150°F..

On a cold engine the pressure spring (item 3) pushes the slide valve (item 2) down. Air can now enter into the intake manifold.

As the water warms up, the thermostat (item 1) expands pushing the slide valve shut.

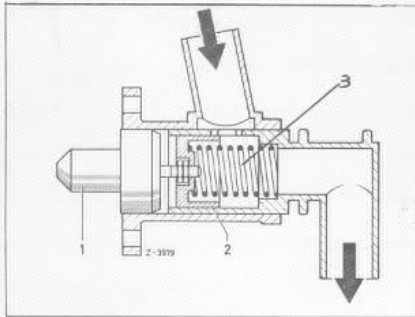

FIG. 17

5. As final correction measure, an AIR TEMPERATURE SENSOR (Fig. 18) located in the air filter housing causes a fuel enrichment up to an air temperature of 70 F.. The sensor works on the same variable resistance principle as the water sensor.

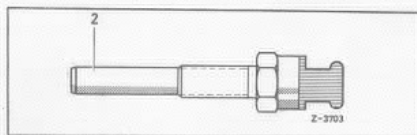

FIG. 18

6. The preceding information explained which devices establish the input data. They are:

1. Pressure Sensor
2. Trigger Points
3. Throttle Switch
4. Water Temperature Sensor
5. Air Temperature Sensor

All this data is fed into the ELECTRONIC CONTROL UNIT (Fig. 19) by means of electrical current signals.

In the control unit, or better known as "brain box", the received information is processed by various transistors, diodes, capacitors, potentiometers, etc.

The output data which again consists of electrical current impulses, controls the operation of the injection valves.

The control unit also controls the fuel pump safety circuit, as mentioned earlier.

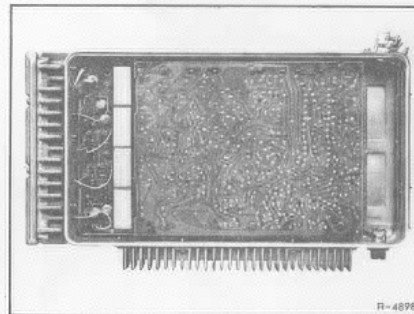

FIG. 19 COVER REMOVED

7. The ELECTRIC INJECTION VALVES (Fig. 20) work identical to an electro-magnetic solenoid. Under current, a magnetic field is produced by the coil (item 3) and the armature (item 2) is pulled against the closing spring (item 4), thus opening the nozzle needle (item 1).

At this moment, the pressurized fuel (28.4 psi) at the nozzle tip is sprayed into the intake port.

Depending on the engine's operating condition, the valve stays open from a minimum of 2/1000 second, to a maximum of 10/1000 of a second.

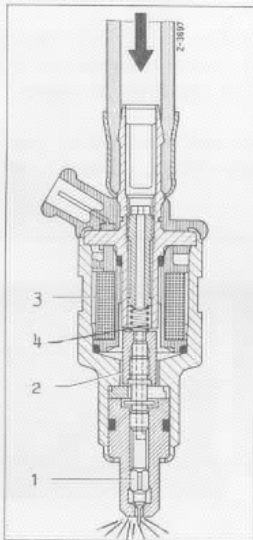

FIG. 20

NOTES

C. MAINTENANCE

Contrary to the mechanical fuel injection system which needed occasional recalibration because it employed primarily mechanical components which are subject to wear, the electronically controlled gasoline injection system is virtually service free. The few service operations which do require periodic attention are outlined below.

1. During the 1st and 2nd service, all fuel hose clamps (Fig. 21) must be checked for tightness. This should be carried out with a cold engine and overtightening must be avoided.

Furthermore, the entire fuel system must be checked for proper sealing every 10,000 miles.

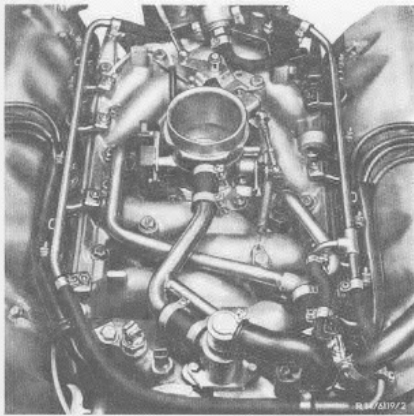

FIG. 21

2. The fuel filter (Fig. 22) should be renewed every 30,000 miles. A more frequent replacement may be advisable under unfavorable operating conditions.

On the M116 engine the filter is located in the engine compartment, while on the M117 engine it is in the back, near the fuel pump.

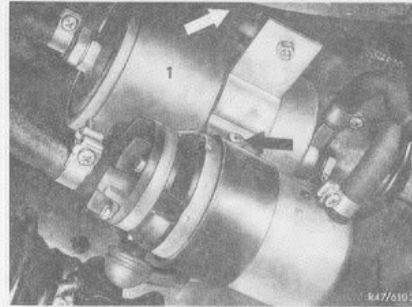

FIG. 22 1 FUEL FILTER

3. In accordance to our cycle services, the idle speed and CO emission should be checked with every maintenance service.

The specified values for idle speed and CO emission can be obtained from the exhaust emission tag, located on the radiator cowl. The procedure calls for first adjusting the idle speed at the air screw (Fig. 23), and then adjust the fuel amount on the electronic control unit (Fig. 24). Turning the knob "clockwise" will enrich the mixture.

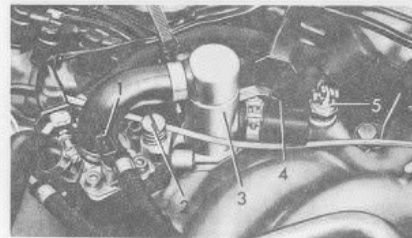

FIG. 23 2 AIR SCREW

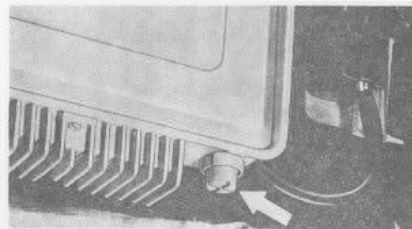

FIG. 24

4. Aside from the regular scheduled maintenance items, it may become necessary to check and adjust the fuel pressure. For this purpose, a pressure gauge is connected to the fuel loop (Fig. 25). Should the value be other than 28.4 psi, it can be corrected by adjusting the pressure regulator (Fig. 26).

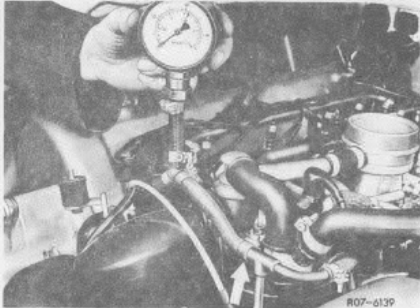

FIG. 25

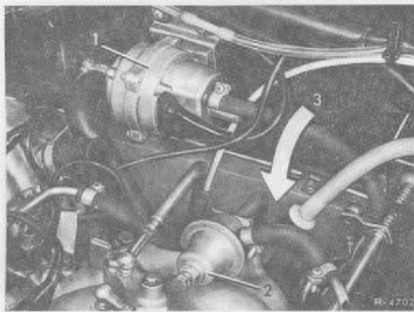

FIG. 26 2 PRESSURE REGULATOR

5. Should the test procedure reveal that the throttle valve switch (Fig. 26) needs adjustment, it must be performed with utmost care. For easier accessibility, it is advantageous to remove the throttle valve (item 1).

The switch (item 2) can be moved after loosening fastening screws (items 3). With tester (ohm meter) connected and ignition on, turn switch until needle moves from " ∞ " to "0". Move switch from this position by $\frac{1}{2}$ graduation mark (1 $^{\circ}$) counter clockwise and tighten. Recheck adjustment.

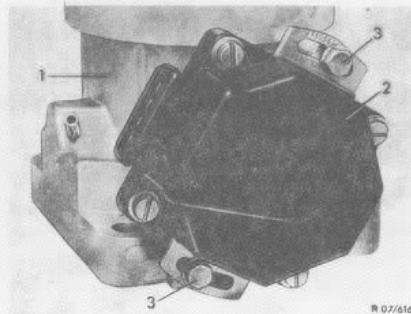

FIG. 27
1 THROTTLE VALVE
2 THROTTLE SWITCH
3 FASTENING SCREWS

D. DIAGNOSTIC HINTS

Unlike vehicles of yesteryear where an experienced technician could make an accurate diagnosis by simply lifting the hood or driving the car around the block, current technology, applied in the production of automobiles, requires modern test equipment.

Especially on an unitized system such as the electronic fuel injection, a malfunction of one sensor could have the same symptoms as another.

Following is a test procedure for the Bosch EFAW 228 Tester which was specifically developed for this system.

Another tester made by Janbo serves the same purpose. Since this device comes with its own instructions, we will not elaborate any further.

INDEX

- 07.4 - 0/1 WIRING DIAGRAM FOR EFI SYSTEM
- 07.4 - 0/2 LOCATION OF RELAYS
- 07.4 - 2 BOSCH TESTER EFAW 228 TEST PROGRAM
- 07.4 - 3 DETAILED TROUBLE SHOOTING PROCEDURES
FOR EFI SYSTEM



Subject: Electronic Fuel Injection

Chapter: 07.4

Revised: 2-74

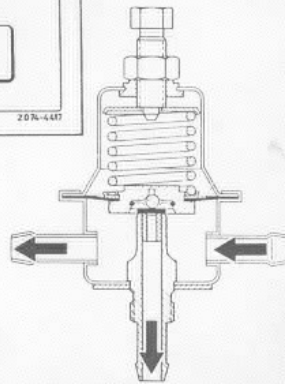
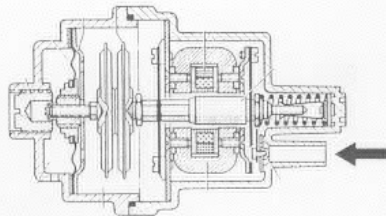
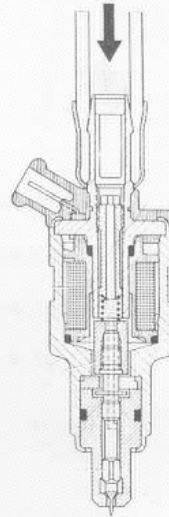
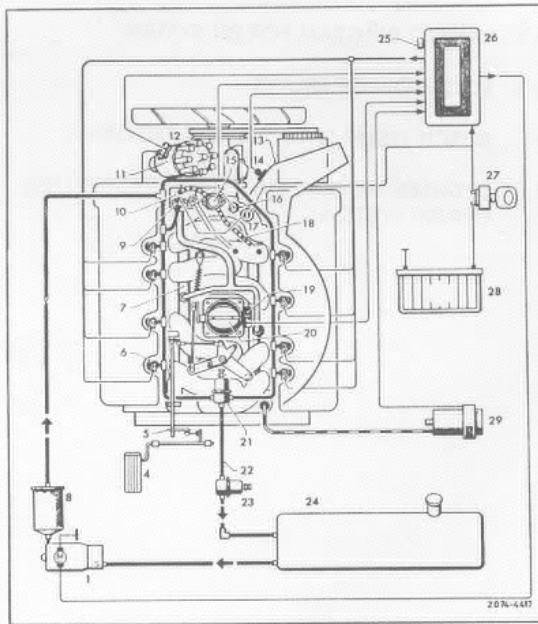
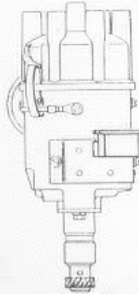
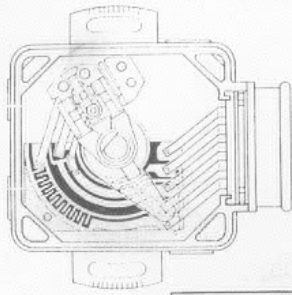

WIRING DIAGRAM FOR EFI SYSTEM

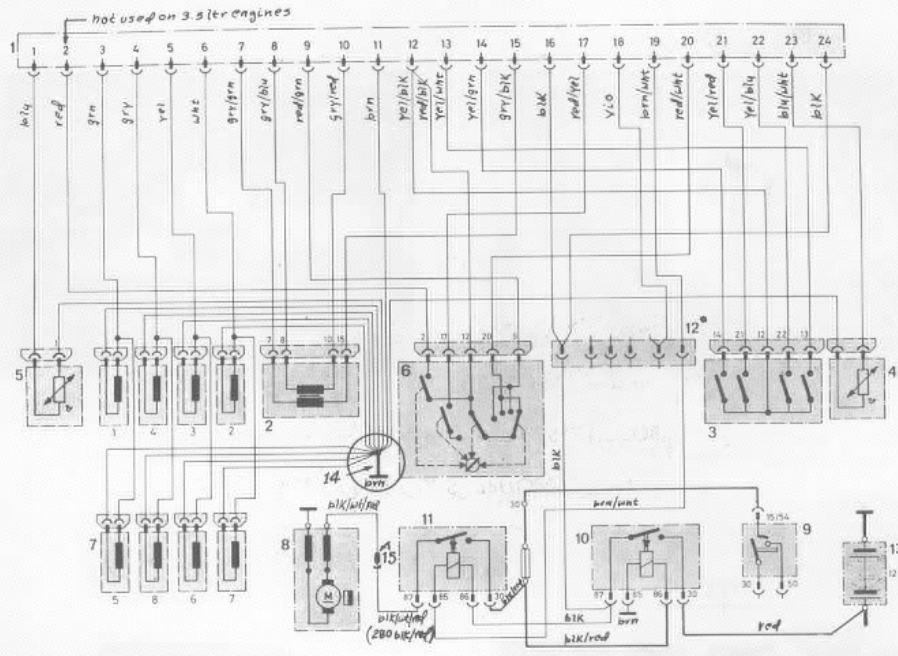

- | | |
|--|---|
| <ul style="list-style-type: none"> 1 Plug board (control unit) 2 Pressure sensor 3 Trigger points of the distributor 4 Temperature sensor (coolant) 5 Temperature sensor (air) 6 Throttle valve switch 7 Injection valves (cylinders 1-8) 8 Fuel pump 9 Ignition switch | <ul style="list-style-type: none"> 10 Main relay for power supply to control unit 11 Pump relay 12 Adapter plug for connection to vehicle's main wiring harness 13 Battery 14 Harness ground 15 Twelve pin plug for tail light harness under dash |
|--|---|

LOCATION OF RELAYS

TYPE 116

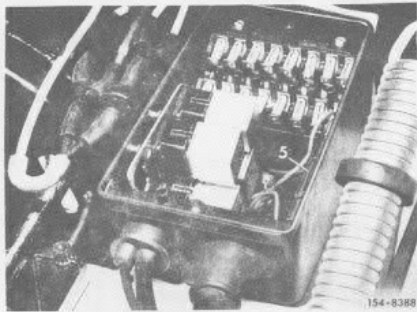

Key No. 1 Relay fuel pump
Key No. 2 Relay cold start valve

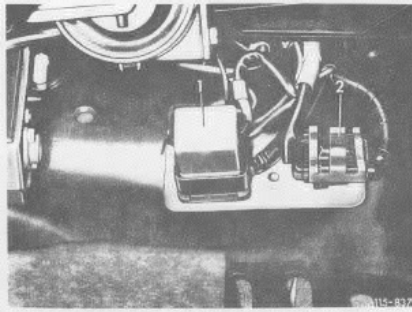

1 Main relay, electronic fuel injection system
2 Plug connection, automatic antenna

TYPE 107

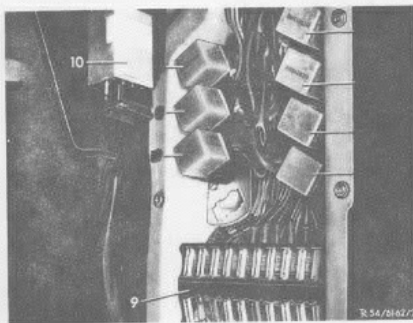

1 Relay for electric fuel pump
2 Relay for starting valve
3 Relay for electronic control unit
4 Relay for starter terminal 50
9 Fuse box
10 Time delay switch for heated rear window

TYPE 108/109

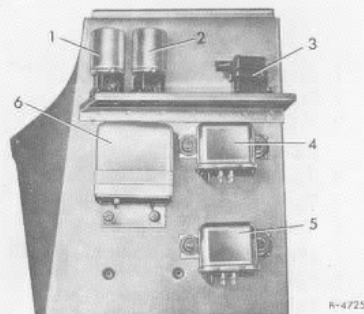

1 Relay for auxiliary lamp
2 Relay for cold start valve
3 Cable connector between main and additional cable harness for electronically controlled injection system
4 Relay for voltage supply of electronically controlled injection system
5 Relay for fuel pump
6 Regulator for three-phase alternator

F. Adjusting Throttle Valve Switch

On the sending unit "throttle valve switch" an adjustment is possible; when replacing this component, adjustment is imperative.

The throttle valve switch should start working the moment the throttle valve has opened by 1° from its closed position. To make adjusting easier markings are stamped on the base plate of the throttle valve switch (1 stroke = 2°). The marks are opposite an index mark on the intake pipe.

The throttle valve switch is accessible after the air filter housing has been removed.

Adjustment is done as follows:

Connect Bosch Tester EFAW 228 as described on page 43, put switch "A" on position "Measuring" (Messen), switch B on position "Throttle valve switch III" (Drosselklappenschalter III).

Fit switch (2) to throttle valve shaft and tighten the two mounting screws (3) finger-tight. Fit four-point plug and switch on ignition. Turn switch so far until the needle of the instrument moves from "∞" to "0". From this position turn switch by 1/2 mark (1) in clockwise direction and tighten firmly.

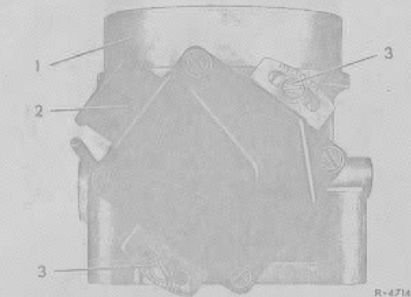

Fig. 59 Adjustment of throttle valve switch

- 1 Venturi control unit
- 2 Throttle valve switch
- 3 Mounting screws

G. Adjustment of Idle Fuel Mixture

The injection quantity can be varied by $\pm 10\%$ with the adjustment screw at the electronic control unit (2). For adjustment pull up water protective cover.



Fig. 60 Setscrew on electronic control unit

- 1 Water cap
- 2 Control unit
- 3 Setscrew
- 4 Air-cooled oil cooler

07.4 - 2 BOSCH TESTER EFAW 228 TEST PROGRAM

Tester Application

The following test program using tester and fuel pressure gauge will locate the following:

- A. Certain faults in the sending units.
- B. Injection wiring harness problems.
- C. Fuel system problems.
- D. Priming system problems.

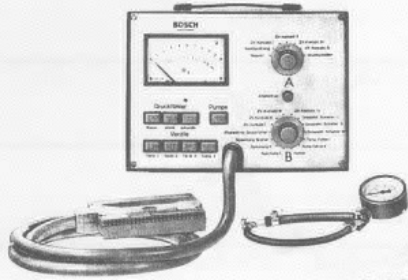

Important Points

- A. The test program must be done in sequence.
- B. Any problem found must be corrected before continuing with the test.
- C. To find faulty connections, move the pertinent cables and connections, while performing the test.
- D. When a problem is located with the tester, refer to:
07.4-3 Detailed Shooting Procedures for the EFI system.

Test Program

- A. Control Unit Removed.
 - 1. Disconnect coil high tension lead and ground.
 - 2. Remove control unit and plug Bosch Tester into the plug board of the injection system harness.
 - 3. Install fuel pressure gauge.
Caution! Fuel system is under pressure!!
 - 4. Turn Ignition on for the entire test program.
 - 5. Switch "A" at "Measuring".
 - 6. Switch "B" at (see following page)

SWITCH "B" AT:	OPERATION:	YOU ARE TESTING:	DESIRED RESULT:
VOLTAGE I	IGNITION ON (ENTIRE TEST PROGRAM)	VOLTAGE AVAILABLE FOR THE INJECTION SYSTEM.	11 TO 12.5 ON VOLT SCALE
VOLTAGE II	IGNITION ON (ENTIRE TEST PROGRAM)	VOLTAGE AVAILABLE FOR THE INJECTION SYSTEM.	11 TO 12.5 ON VOLT SCALE
STARTING VOLTAGE	CRANK ENGINE	VOLTAGE TO INJECTION SYSTEM DURING CRANKING	9 TO 12 ON VOLT SCALE
ADJUST ∞ PRESSURE SENSOR	CALIBRATE INSTRUMENT TO " ∞ " BY TURNING BALANCE KNOB		
	PRESS BUTTON "GROUND"	INSULATION OF PRESSURE SENSOR AND CABLES	∞
	PRESS BUTTON "PRIMARY"	RESISTANCE OF PRIMARY WINDING OF PRESSURE SENSOR INCLUDING CABLES	0.5 TO 1.0 ON OHM SCALE (APPROX. 90 Ω)
	PRESS BUTTON "SECONDARY"	RESISTANCE OF SECONDARY WINDING OF PRESSURE SENSOR INCLUDING CABLES	3 TO 4 ON OHM SCALE (APPROX. 350 Ω)
DISTRIBUTOR CONTACT I THEN II THEN III THEN IV	CRANK ENGINE	TRIGGER CONTACTS IN THE DISTRIBUTOR	HAND OF INSTRUMENT REGISTERS DURING CRANKING. (IT <u>DOES NOT</u> STAY AT 0 OR ∞)
THROTTLE VALVE SWITCH I THEN II	SLOWLY DEPRESS ACCELERATOR PEDAL	FUEL ENRICHMENT FOR ACCELERATION	HAND OF INSTRUMENT OSCILLATES FROM "0" TO " ∞ " APPROXIMATELY 10 TIMES. WHEN RELEASING ACCELERATOR, THE HAND OF INSTRUMENT MUST STAY AT " ∞ " UNTIL THROTTLE RETURNS TO IDLE.
THROTTLE VALVE SWITCH III	THROTTLE VALVE AT IDLE (CLOSED)	CONTACTS IN THROTTLE VALVE SWITCH	0 Ω
	THROTTLE VALVE SLIGHTLY OPENED (ABOUT 1°)	CONTACTS IN THROTTLE VALVE SWITCH	∞

SWITCH "B" AT:	OPERATION:	YOU ARE TESTING:	DESIRED RESULT:
TEMP. SENSOR I (INTAKE AIR)		RESISTANCE OF	AIR (F°) OHM SCALE*
		TEMPERATURE SENSOR	105° 0.5 TO 2.5
		IN RELATION TO AIR	85° 1 TO 3
		TEMPERATURE	70° 2 TO 4
			50° 3 TO 5
		32° 5.5 TO 7.5	
			*ACTUAL VALUE = SCALE VALUE X 100
TEMP. SENSOR II (COOLING WATER)		RESISTANCE OF	WATER (F°) OHM SCALE*
		TEMPERATURE SENSOR	212° 0.1 TO 0.3
		IN RELATION TO	180° 0.2 TO 0.4
		WATER TEMPERATURE	140° 0.5 TO 0.7
			105° 1.0 TO 1.5
	70° 2 TO 3		
		32° 5.5 TO 6.5	
			*ACTUAL VALUE = SCALE VALUE X 1000
VALVES (IF REQUIRED, ADJUST ∞)	UNPLUG THE FOUR INJECTION VALVES ON ONE SIDE OF THE ENGINE. DEPRESS VALVE BUTTONS ONE AT A TIME.	RESISTANCE OF VALVE WINDING INCLUDING CABLES	2 TO 3 OHM SCALE
TESTER BUTTON CHECKS:			
CYL.			
BUTTON 4 =	(4) ↔ (8)		
BUTTON 2 =	(3) ↔ (7)		
BUTTON 3 =	(2) ↔ (6)		
BUTTON 1 =	(1) ↔ (5)		
(FRONT)			
REPEAT PROCEDURE FOR VALVES ON OTHER SIDE OF ENGINE		SAME	
(SWITCH "B" TESTS CONCLUDED - POSITION OF SWITCH "B" HAS NO INFLUENCE ON SWITCH "A")			

SWITCH "A" AT:	OPERATION:	YOU ARE TESTING:	DESIRED RESULT:
VALVE CHECK FOR: FUEL SYSTEM PRESSURE	PRESS BUTTON "PUMP"	FUEL PRESSURE SETTING	28.5 ± 0.5 PSI
FOR: FUEL SYSTEM LEAK DOWN	PRESS BUTTON "PUMP" FOR A SHORT TIME	FUEL SYSTEM FOR INTERNAL PRESSURE LEAK DOWN	PRESSURE SHOULD DROP TO APPROX. 17 PSI AND HOLD.
FOR: PRIMING SYSTEM AT COOLING WATER <u>ABOVE</u> 95° F	A. PRESS "PUMP" BUTTON BRIEFLY TO REGISTER A PRESSURE ON FUEL GAUGE. CRANK ENGINE FOR ONE SECOND.	PRIMING VALVE SYSTEM, THERMO- TIME SWITCH ABOVE 95° F.	PRESSURE ON GAUGE SHOULD <u>NOT</u> DROP INDICATING SWITCH IS NOT GROUNDED.
FOR: PRIMING SYSTEM CIRCUIT	B. GROUND CONNECTION "W" OF THERMO-TIME SWITCH PLUG. CRANK ENGINE FOR ONE SECOND.	PRIMING VALVE AND CABLES	PRESSURE ON GAUGE <u>SHOULD</u> DROP INDICATING VALVE OPENS.
FOR: PRIMING SYSTEM AT COOLING WATER <u>BELOW</u> 95° F	PRESS "PUMP" BUTTON TO REGISTER A PRESSURE ON FUEL GAUGE. CRANK ENGINE FOR ONE SECOND.	PRIMING SYSTEM THERMO-TIME SWITCH OPERATION BELOW 95° F.	PRESSURE ON GAUGE <u>SHOULD</u> DROP INDICATING SYSTEM OPERATES.

TESTING WITH CONTROL UNIT CONNECTED
ON NEXT PAGE

B. TESTING WITH CONTROL UNIT CONNECTED

1. SWITCH OFF IGNITION.
2. REMOVE PRESSURE GAUGE.
CAUTION! SYSTEM UNDER PRESSURE.
3. PLUG CONTROL UNIT INTO BOSCH TESTER PLUG IN ADDITION TO WIRING HARNESS BEING PLUGGED INTO TESTER PLUG.

SWITCH "A" AT:	OPERATION:	YOU ARE TESTING:	DESIRED RESULT:
DISTRIBUTOR CONTACT I THEN II THEN III THEN IV	START ENGINE IN "DIS. CON. I" POSITION. RUN AT APPROXIMATELY 2000 RPM. SWITCH FROM POS. I THROUGH IV.	TRIGGER CONTACTS IN THE DISTRIBUTOR	HAND OF INSTRUMENT OSCILLATES AT A CERTAIN VALUE. THE VALUE SHOULD BE THE SAME IN ALL FOUR POSITIONS. TWO MARKS DIFFERENCE ON THE VOLT SCALE IS ALLOWED.

4.5 LTR ONLY!

PRESSURE SWITCH	OPEN THROTTLE ALL THE WAY BY SLOWLY DEPRESSING PEDAL INSIDE CAR.	FULL THROTTLE ENRICHMENT IN THROTTLE VALVE SWITCH.	A READING OF 2 TO 5 VOLTS AVAILABLE, 5° <u>BEFORE</u> REACHING FULL THROTTLE.
-----------------	--	---	---

07.4 - 3 DETAILED TROUBLE SHOOTING PROCEDURES FOR THE EFI SYSTEM

The following procedures are a means of checking each circuit of the EFI system to pin point a problem in the circuit.

Specifically, this test program begins where an EFI tester program ends. If you have a problem in a circuit, an EFI tester will indicate this, but it will not show you exactly where the problem is. You must trouble shoot the problem circuit to locate the specific cause, such as a defective sensor or emitter, bad ground, loose or broken cable, defective relay, etc. Use this trouble shooting program as follows:

1. When a problem is indicated by your EFI tester, turn off the ignition and unplug the tester. The trouble shooting will be done with a standard voltmeter, ohm meter, small probes and jumper lead.
2. Locate the trouble shooting information in this text which covers the problem area indicated by your EFI tester. For example, if your tester indicates a problem in the part of the program which tests the injection valves, refer to the 'Injection Valves' trouble shooting procedures. If a problem is indicated in any of the fuel system checks, refer to the 'Fuel Systems' trouble shooting procedures, and so on.
3. Follow the testing instructions in each trouble shooting tree carefully and in sequence. This will lead you to the cause of the problem by the quickest route.

INDEX

- 07.4 - 3/3 MAIN VOLTAGE SUPPLY TO EFI SYSTEM
- 07.4 - 3/5 FUEL SUPPLY TO EFI SYSTEM
- 07.4 - 3/8 DISTRIBUTOR CONTACTS
- 07.4 - 3/9 INJECTION VALVES
- 07.4 - 3/11 TEMPERATURE SENSORS
- 07.4 - 3/13 THROTTLE VALVE SWITCH
- 07.4 - 3/15 PRESSURE SENSOR
- 07.4 - 3/17 PRIMING SYSTEM

MAIN VOLTAGE SUPPLY TO EFI SYSTEM
Key on via cables 11 and 16

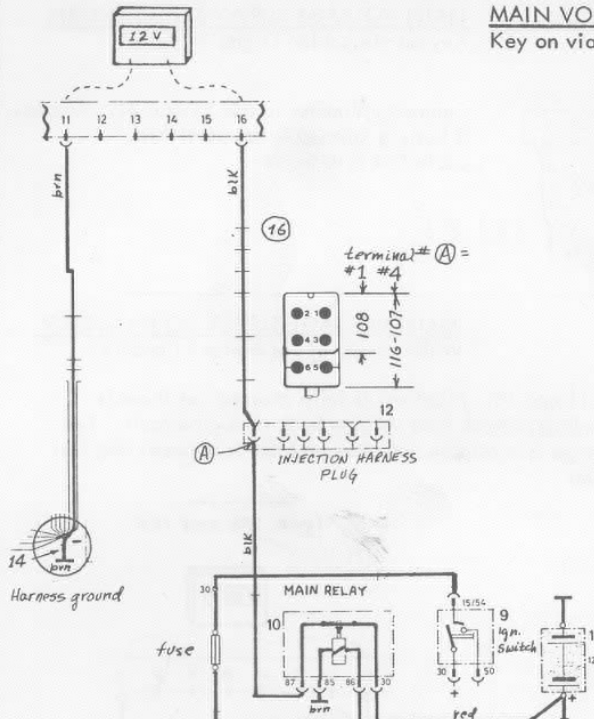

Connect voltmeter to trs. 11 and 16. Key on.
If battery voltage not available:

No Battery charged? YES

Charge battery

No Fuse O.K.? YES

Replace fuse

Unplug a relay you know is working and try it in place of the main relay

Battery Voltage? NO OK? YES

Replace main relay

When the Key is turned on, Can you see the good relay energize? NO YES

Remove relay plug and check voltage at tr. 86 (4 on plug), Key on. NO Battery Voltage? YES

Defect in lead from fuse to tr. 86 of relay plug

Defect in ground lead or ground connection from tr. 85 of relay plug

Remove relay plug and check voltage at tr. 30 NO Battery Voltage? YES

Defect in lead from tr. 30 to battery post

Check voltage at tr. 16 of plug board, Key on. NO Battery Voltage? YES

Unplug injection harness adaptor plug and check voltage at same tr. (A) Key on NO Battery Voltage? YES

Defect in ground lead from tr. 11 of plug board to harness ground (14) or ground connection poor.

Defect in cable from tr. (A) of adaptor plug to tr. 87 of main relay.

Defect in cable from tr. 16 of plug board to tr. (A) of adaptor plug

Two types of relay and plug possible:

PLUGS

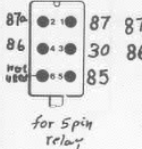

MAIN VOLTAGE SUPPLY TO EFI SYSTEM

Key on via cables 11 and 24

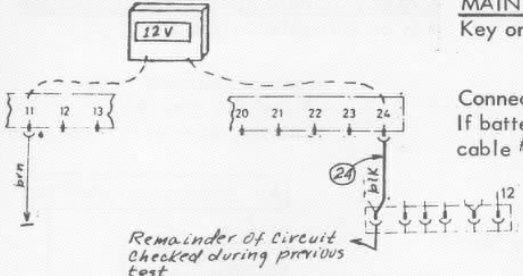

Connect voltmeter to trs. 11 and 24. Key on. If battery voltage is not available, cable #24 is defective.

MAIN VOLTAGE SUPPLY TO EFI SYSTEM

While cranking via cables 11 and 18

Connect voltmeter to trs. 11 and 18. If battery is fully charged but there is less than 9 volts while cranking, check feed voltage back through circuit. Test point where sufficient voltage is available indicates problem is between that test point and previous test point.

type 108

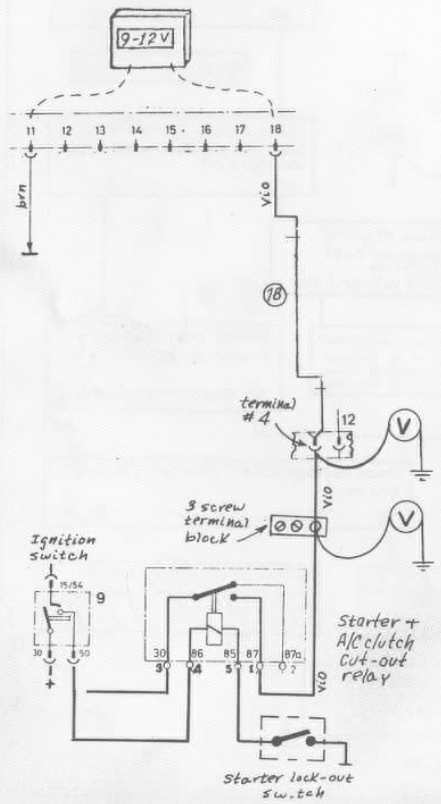

type 116 and 117

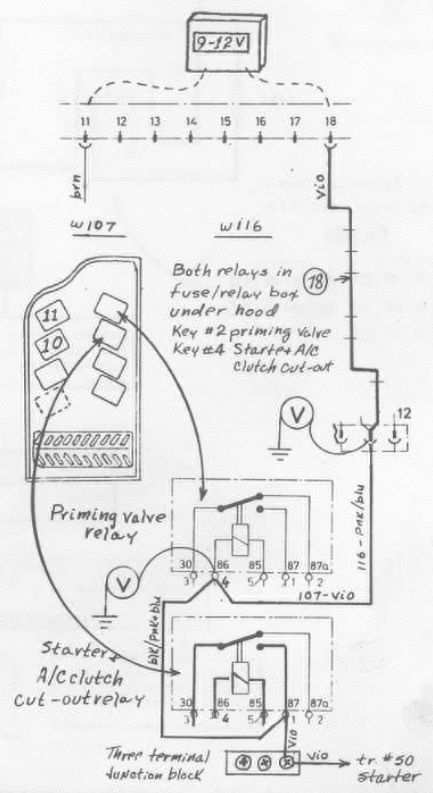

FUEL SUPPLY TO EFI SYSTEM
PROBLEM: FUEL PRESSURE INCORRECT

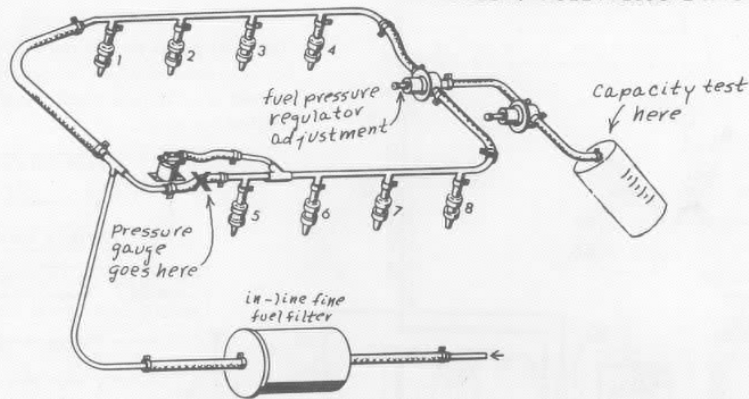

Adjust the fuel pressure regulator to 28.5 psi
YES ADJUSTMENT POSSIBLE? **NO**

If engine performance indicates a lean condition with the correct fuel pressure, perform the FUEL CAPACITY TEST outlined below.

Try a new pressure regulator. A small adjustment may be necessary to provide 28.5 psi. If a larger adjustment is indicated:
Too HIGH PRESSURE INDICATED IS: **Too LOW**

Restriction possible in the fuel return circuit between the pressure regulator outlet and fuel tank return inlet. Eliminate before adjusting pressure regulator

FUEL CAPACITY TEST - Perform to determine if fuel delivery is sufficient.
 Measuring Condition: Engine at idle with 12 volts available at fuel pump and fuel tank at least half full.
 Measuring point: In the return circuit to the fuel tank after the pressure regulator
 Measuring value: At least one liter (one quart) in 30 seconds.
 CAPACITY O.K.? **NO**

YES Repeat the test with the fuel tank filler cap removed
 CAPACITY O.K.? **NO**

Fuel tank venting system not operating. Check vent hole restriction, check venting control valve and lines.

Check all fuel lines for restrictions or kink
NO PROBLEM LOCATED? ← Repeat the test after replacing in-line fuel filter
NO CAPACITY O.K.?

Try new fuel pump. Adjust pressure regulator as necessary to 28.5 psi and check capacity

FUEL SUPPLY TO EFI SYSTEM

PROBLEM: PRESSURE LEAKS DOWN WHEN ENGINE IS NOT RUNNING

If fuel pressure does not hold at approx. 17 psi after the pump shuts off, but drops to zero in a short time, the leakage is at one of the four places indicated:

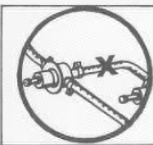
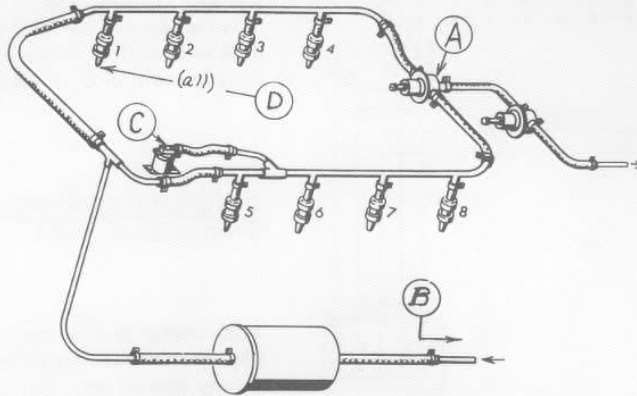

Run fuel pump to build up pressure. Immediately after pump stops, clamp fuel line shut at return outlet of pressure regulator

NO DOES PRESSURE HOLD NOW? YES

Pressure regulator leaks.
NOTE: Not critical, fuel returns to fuel tank.

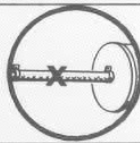

Run fuel pump to build up pressure. Immediately after pump stops, clamp fuel line shut at fuel filter

NO DOES PRESSURE HOLD NOW? YES

Fuel pump check valve leaks.
NOTE: Not critical, fuel returns to tank.

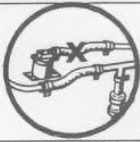

Run fuel pump to build up pressure. Immediately after pump stops, clamp fuel line shut at priming valve.

NO DOES PRESSURE HOLD NOW? YES

Priming valve leaks. Replace Priming Valve.

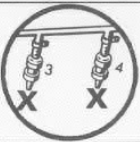

Injection valve/s leak. To find leaking valve/s, remove valves from engine leaving them connected to the fuel system. Run fuel pump and observe valves. Valve tip may become moist, but no more than 2 drops of fuel per minute may leak out. Replace leaking valves.

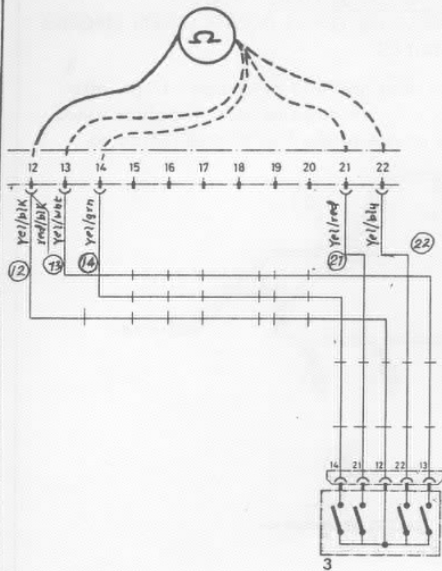

DISTRIBUTOR CONTACTS WHILE CRANKING

Four contact sets circuits individually via:
 Cables #12 and #13 Cables #12 and #21
 Cables #12 and #14 Cables #12 and #22

Connect ohm meter to trs. #12 and other as noted above. If the hand of the instrument does not oscillate during cranking and/or stays in position 0 or ∞, check:

DISTRIBUTOR CONTACTS AT REST

(Connections as above)

Bump starter to close contact set (0Ω). No apparent resistance should register on any contact set. Tap on distributor at contact set assembly. The reading should be stable.

ADDITIONAL HINTS REGARDING THE TRIGGER CONTACTS

An intermittent missing in the engine may be caused by the trigger contacts occasionally not making good contact. This condition may not be seen during testing with a needle type tester since the instrument needle might not react quickly enough to indicate this occasional problem.

INJECTION VALVES

Circuit for injection valves via:
 Cables #11 and #3 for cylinders 1 and 5
 Cables #11 and #4 for cylinders 4 and 8
 Cables #11 and #5 for cylinders 6 and 3
 Cables #11 and #6 for cylinders 7 and 2

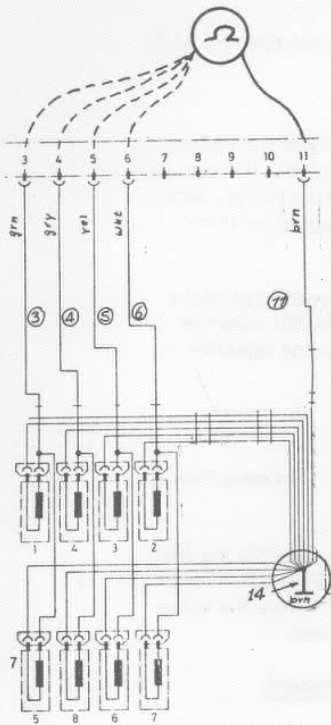

Unplug all four injection valves on one side of the engine. Connect ohm meter to trs. #11 and #3,4,5,6 respectively. Valves remaining plugged in are being tested. Reverse procedure for testing other four valves.

If the reading of any valve is other than 2 to 3 ohms:

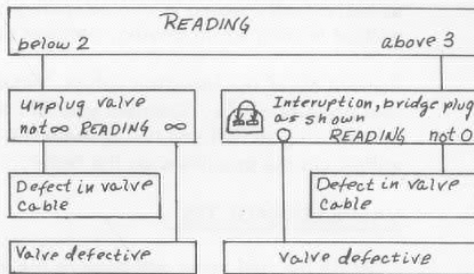

see 'Additional hints regarding the Injection Valves' (next page)

VALVE PAIRS

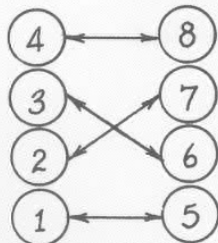

ADDITIONAL HINTS REGARDING THE INJECTION VALVES

There are two conditions to consider when checking the injection valves.

ELECTRICAL:

The winding of the valve, and connecting cables, are checked with the EFI tester.

MECHANICAL:

The proper opening, shutting, spraying and delivery of the valves, is dependent on the mechanical condition of the valve. If there are indications of mechanical problems with the injection valves, such as individually sooted or burned spark plugs, or surging or intermittent missing while driving, proceed as follows:

Remove all of the injection valves, leaving them connected to the fuel pressure circle. Connect your EFI tester to the EFI injection harness plug so that you can operate the fuel pump and injection valves via the provisions on the tester.

VALVE LEAKAGE TEST

Operate the fuel pump and observe the valve tips. No more than 2 drops of fuel per minute may leak from any valve.

Place containers under the valves to be checked. Operate the fuel pump and the respective injection valves via the EFI tester. Some testers require disconnecting one valve of the pair before the valve will open. The fuel should spray in an atomized form.

VALVE DELIVERY TEST (at 28.5 psi fuel system pressure)

Place graduated container (e.g., baby bottle) under the valve to be checked. Disconnect other valve in set.

Operate the pump and the respective valve at the same time.

In 30 seconds, the valve should deliver 200 to 210 cc of fuel.

Replace the valve if below 200 cc delivery amount.

AIR TEMPERATURE SENSOR
Circuit via cables 11, 1 and A

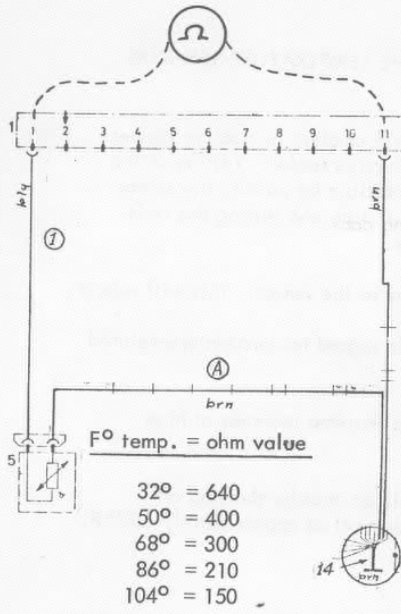

Connect ohm meter to trs. 11 and 1.
If the ohm reading of the air temp. sensor is not correct in relation to the air temperature:

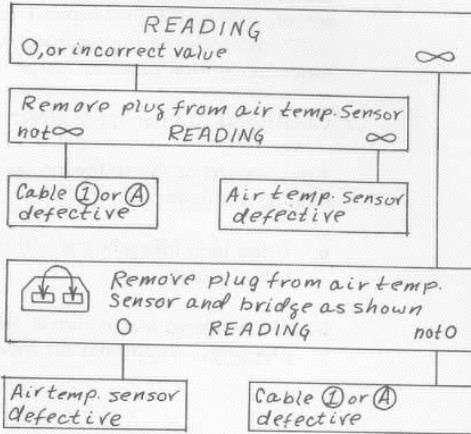

WATER TEMPERATURE SENSOR
Circuit via cables 11, 23 and B

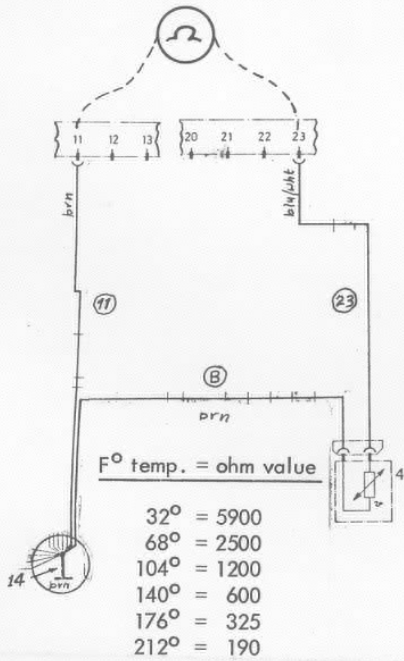

Follow the same trouble shooting procedure as above for the air temperature sensor, except cables 23 and B apply. (see schematic)

see 'Additional hints regarding the temperature sensors' (next page)

ADDITIONAL HINTS REGARDING THE TEMPERATURE SENSORS

Running problems encountered at certain ambient or coolant temperatures indicate the possibility of a defective sensor. Testing of the sensors at a particular temperature is possible by putting the sensor bulb into water of the pertinent temperature and testing the resistance in relation to water temperature.

CAUTION! Do not apply direct flame to the sensor. This will ruin it.

Also, remember the following points in regard to temperature-related running problems:

- a. A too lean idle mixture will cause extreme leanness at high temperatures.
- b. The warm-up mechanism sliding piston must be shutting off properly. Additional air should shut off at approximately 150° F.

THROTTLE VALVE SWITCH

Acceleration enrichment via:

Cables #12 and #9 - Cables #12 and #20

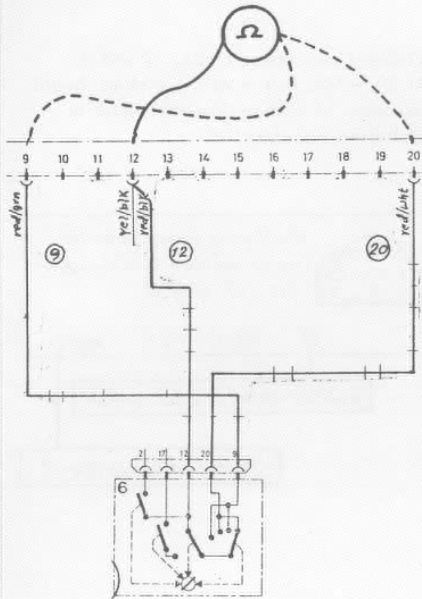

Connect ohm meter to trs. 12 and 9, then 12 and 20. Slowly depress accelerator pedal. If the hand of the instrument does not oscillate approx. 10 times between 0 and ∞ , and/or does not read ∞ while releasing the throttle (until idle position):

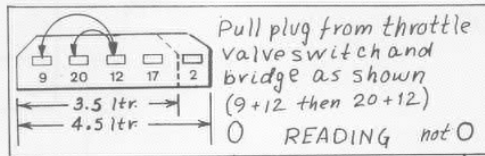

Throttle valve Switch defective

Cable in question is defective

THROTTLE VALVE SWITCH

Idle circuit via cables 12 and 17

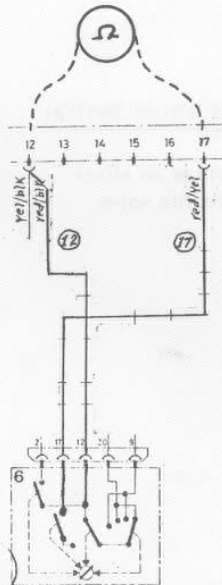

Connect ohm meter to trs. 12 and 17. If 0 is not indicated at idle:

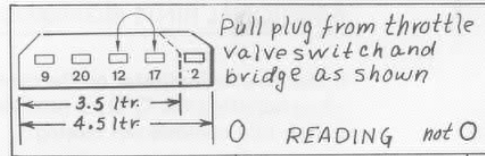

Replace Switch

Defect in cable (12) or (17)

IF ∞ is not indicated by 1° of throttle valve opening:

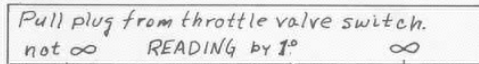

Defect in cable (12) or (17)

Replace switch

THROTTLE VALVE SWITCH (4.5 ltr.)
 Full load enrichment via cables 12 and 2

Connect ohm meter at trs. 12 and 2.
 At 5° before full throttle, 0 ohms should register. If 0 ohms do not register at 5° before full throttle:

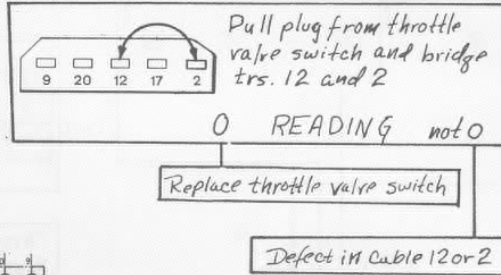
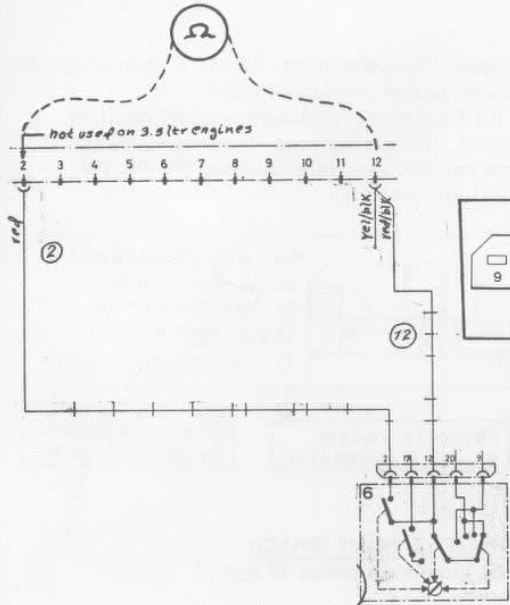

ADDITIONAL HINTS REGARDING THE THROTTLE VALVE SWITCH

If the idle fuel adjuster on the control unit has little or no effect when adjusting the C/O, a possible cause is the throttle valve switch idle contacts not closing.

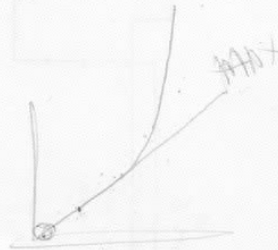

PRESSURE SENSOR

primary winding via cables 7 and 15

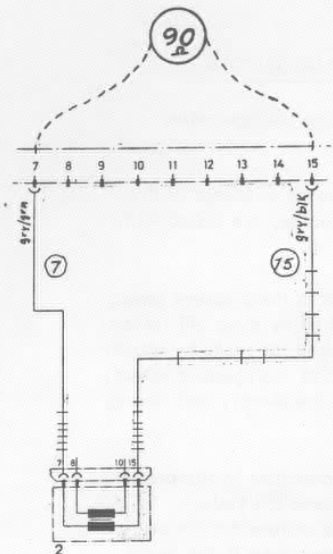

Connect ohm meter to trs. 7 and 15
If reading is other than approx. 90 ohms:

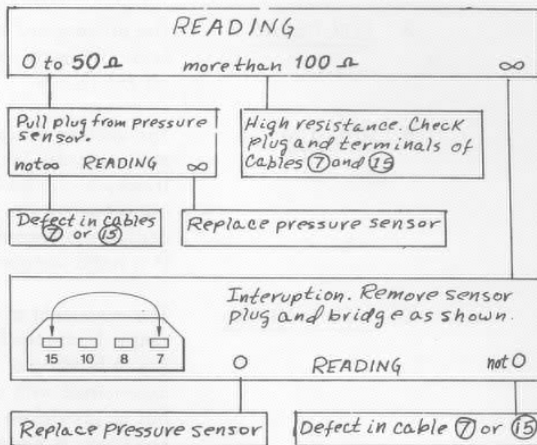

PRESSURE SENSOR

Secondary winding via cables 8 and 10.

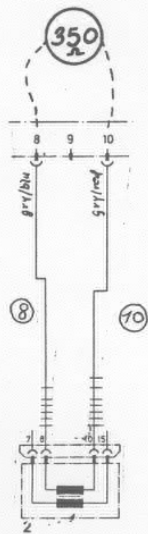

Connect ohm meter to trs. #8 and #10.
If reading is other than approx. 350 ohms:

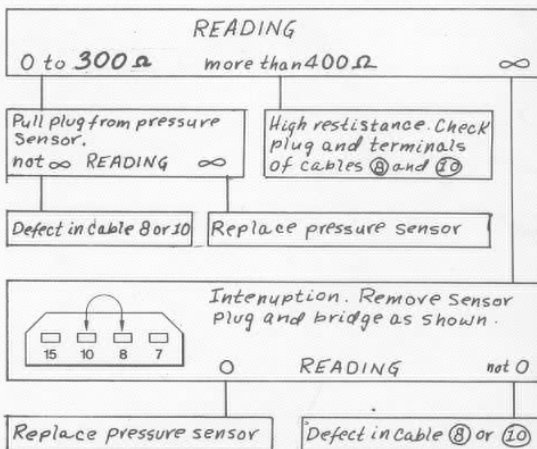

ADDITIONAL HINTS REGARDING THE PRESSURE SENSOR

There are three conditions involved in controlling the operation of the pressure sensor:

- A. ELECTRICAL: The primary and secondary windings in the pressure sensor, and cables, are tested with all EFI testers.
- B. VACUUM: The vacuum diaphragm in the pressure sensor automatically is checked by some EFI testers. If not, it can be checked for leaks by attaching a hose to the inlet of the pressure sensor, applying a vacuum to the sensor, and seeing if it holds vacuum.
- C. MECHANICAL: The movement of the armature in the pressure sensor is checked by some EFI testers. Sticking or binding of the armature cannot be determined with any accuracy if the tester has no provisions for testing this. If this condition is suspected, try a new pressure sensor to see if the problem is eliminated.

PRIMING SYSTEM

The priming system wiring is included in the EFI system harness, but is not a function of the EFI system.

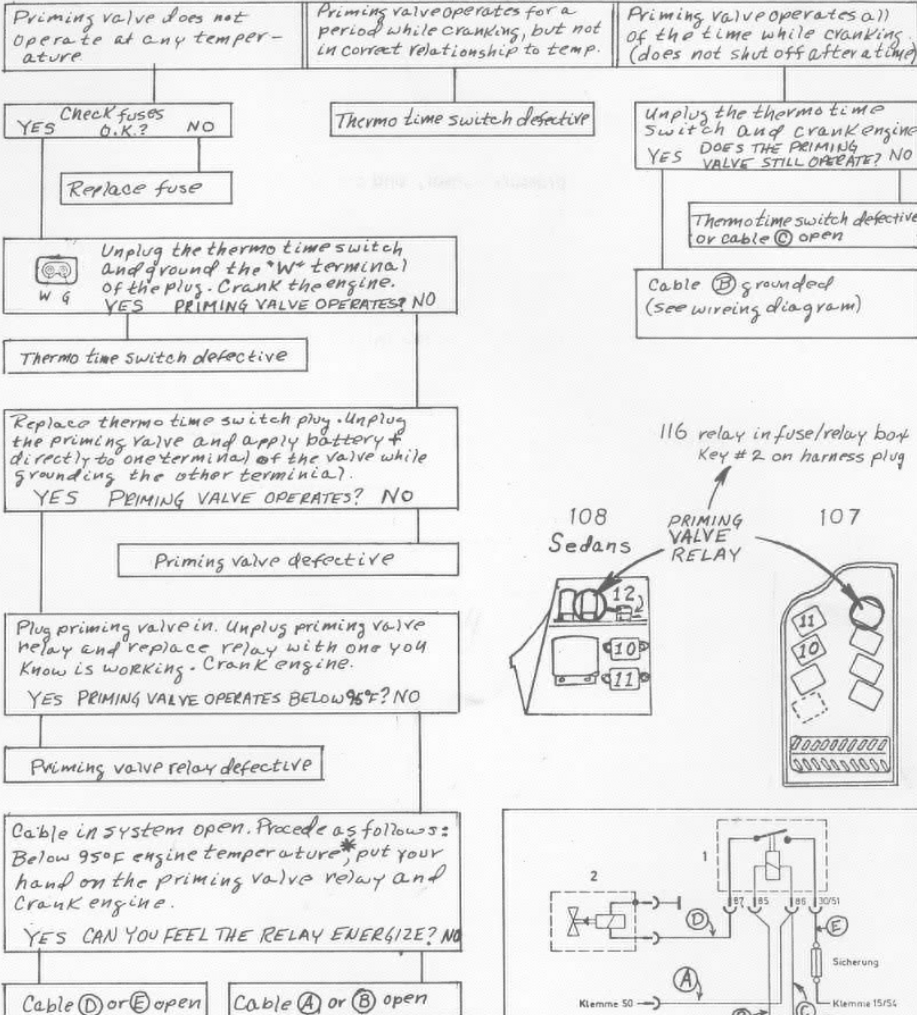

* or ground 'W' terminal of thermo-time switch plug.

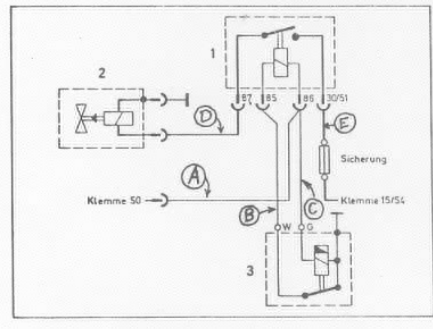
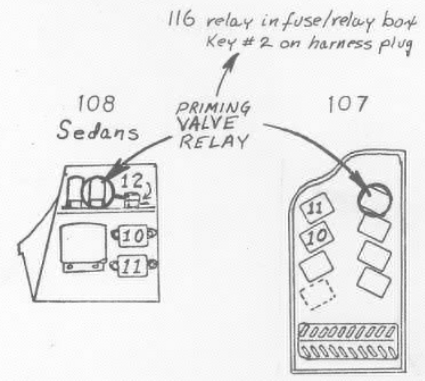

Wiring diagram of starting device
 1 Relay 3 Thermal time switch
 2 Starting valve