

Mercedes-Benz

450 SL

450 SLC



service

Owner's Manual



Mercedes-Benz

450 SL

450 SLC

(107)

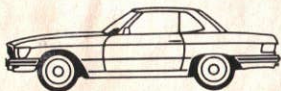

Owner's Manual



You have chosen to drive a MERCEDES-BENZ, a car in whose construction and production we have taken great pains because we believe that quality is not a matter of chance.

Perhaps you have already had experience with a MERCEDES, maybe this is your first car from the DAIMLER-BENZ company. In both cases – for your own benefit – please read this owner's manual before putting it away. Even though you have been driving a car for years, some things in this car may be new to you, and this manual certainly contains a few hints which will help you to make the most of your new car.

We wish you safe and pleasant motoring.
DAIMLER-BENZ Aktiengesellschaft

Manual

Contents

This Owner's Manual also describes optional extras as far as an introduction on their handling is required. As these extras need to be ordered separately, the equipment of your vehicle may deviate from the descriptions and illustrations to some extent.

Vehicle Operation

Keys, Doors	8
Master Key and Supplementary Key, Opening, Locking and Unlocking of Doors	8
Master Lock System	9
Seats	10
Front Seat Adjustment	10
Safety Headrest, Safety Belts	11
Windows	13
Electric Window Lifters	13
Instruments and Controls	14
Instrument Cluster, Speedometer, Tachometer, Clock, Indicator Lights	16
Steering Lock, Light Switch ..	18
Combination Switch	19
Heating and Ventilation	20
Air Conditioning System	22
Various Equipment	24
Interior Lights, Sun Visor, Rear View Mirrors	24
Lighter, Heated Rear Window, Radio	25
Roadster Top	26
Cr�pe Hardtop	27
Sliding Roof	28

Driving

Hood	30
Parking Brake	30
Regular Inspections	31
Starting and Turning off the Engine	32
Starting and Shifting Gears	33
Safe Driving, Braking	35
Fuel Consumption, Engine Oil Consumption	35
Brake Warning Light, Charge Indicator, Oil Pressure Gauge, Temperature Gauge, Tachometer, Emission Control	36
Cruise Control	37
The First 1,000 Miles	37
Special Operating Conditions ..	38
Traveling Abroad	38
Winter Driving	38

Contents

Vehicle Care

MERCEDES-BENZ Maintenance System	40
Severe Operating Conditions, Engine Oil Change and Oil Filter Service, Automatic Transmission – Fluid Change and Filter Change	40
Cleaning and Care of the Vehicle	41
Jobs related to Care, Care Products	41
Roadster Top	43

Practical Hints

Ashtrays, Vehicle Tool Kit, Rear Seat Cushion	46
Wheels, Tires, Changing Wheels	47
Checking Fuels, Coolants, Lubricants, etc.	50
Engine Oil Level	50
Coolant Level	50
Automatic Transmission Fluid Level	51
Electrical System	52
Replacing Bulbs	52
Spark Plugs, Battery	55
Fuses, Electric Sliding Roof Emergency Operation	56
Emergency-starting and Towing the Vehicle	57

Technical Data, Fuels, Coolants, Lubricants, etc.

Identification Plates, Vehicle Data Cards	60
Technical Data	61
Fuels, Coolants, Lubricants, etc.	63
Capacities	63
Engine Oils, Fuels	63
Coolants, Treating Agents, Antifreeze	63
Service-Literature	63



Vehicle Operation

Keys Doors

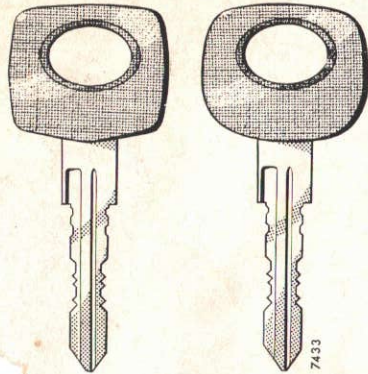

Master Key – square headed – fits locks on the car.

Complementary Key – rounded head – fits only the door locks and the parking lock. This key is intended to be used whenever the car is left in an attendant. Be sure to lock the glove compartment and trunk with the master key.

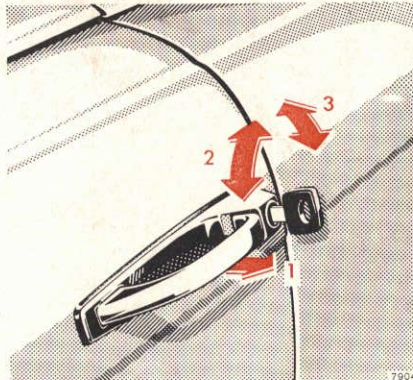

Opening the Doors

From outside: swing handle outwards (1).

From inside: pull handle in door panel (4).

Locking and Unlocking of Doors

From the outside: turn key.

From the inside: actuate safety catch.

2 Unlocking

3 Locking

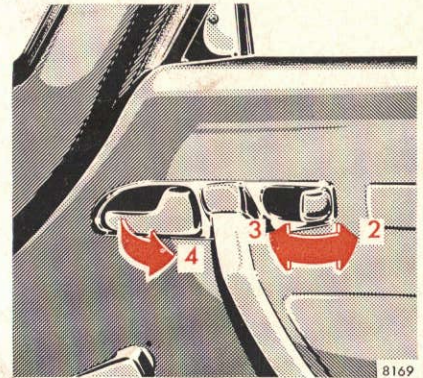

One cannot lock from inside:

- the driver's door if it is open.
- each door if the door lock has not engaged fully. In this case open the door and close it again.

Master Lock System

The master lock system enables the front passenger door, the fuel tank filler flap and the trunk lid to be locked or unlocked together with the driver's door. When locking or unlocking, the locking slides on both doors must move simultaneously. If one locking slide fails to do so, the lock of that particular door is not properly engaged. The door must then be opened and close correctly.

With the master lock system in the **locked** position, the front passenger door can be locked and unlocked either with the locking slide or with the key.

Actuation of the locking slide on the front passenger door, however, is not possible when the master lock system is in the **unlocked** position.

On a vehicle with master lock system the trunk lid can also be unlocked separately. Turn master

key counterclockwise to the stop, push in the trunk lock button with it and lift the lid. Return the key to its initial position and withdraw it. To lock the lid, close it firmly. It will then be locked again by the master lock system.

A provision has been made to facilitate permanent locking of the trunk lid for positive prevention of access to trunk by unauthorized persons.

Before leaving vehicle with an attendant, lock trunk lock with master key (square head) by turning key clockwise to stop (tumbler slot vertical), then remove square-headed key and provide attendant with round-headed supplementary key. Thus, the trunk lock has been excluded from the operation of the master lock system and cannot be

opened except with the square-headed master key.

To reverse this, turn trunk lock counter-clockwise back to horizontal position of the tumbler slot with master key. Lock will then be reengaged in master lock system, that is, it will automatically be locked or unlocked depending on whether the driver's door is locked or unlocked.

The master lock system operates on vacuum generated by the engine. A reservoir allows the master lock system to be actuated about five times after the engine is turned off. If the system can then no longer be engaged, idle engine for a short period.

If no vacuum is available, doors and trunk have to be locked individually in the normal manner. The fuel tank filler flap, however, remains unlocked.

Seats

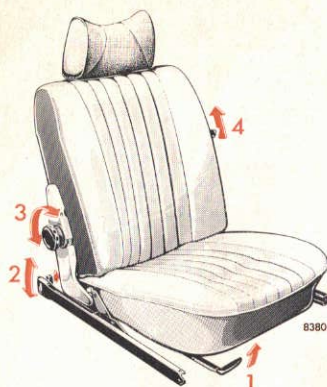

Front Seat Adjustment

Forward/backward adjustment: lift handle (1), push seat backwards or forwards and allow handle to engage.

Height adjustment of driver's seat (3 positions): pull out rotary handles (2) at the rear ends of the guide rails, turn to desired position and allow to re-engage.



The height of the front passenger seat can be adjusted, if necessary, by relocating the guide rails (2 positions). To do so, unscrew both the rear clamping screws and screw in again at the respective bore.

Back rest tilt: turn handwheel (3) back or forth.

450 SL: After disengaging the stop by lifting knob (4), the back rest can be folded forwards.

450 SLC: Backrests are vacuum-locked when the doors are closed. One can unlock them from the rear seat by means of a button (5) accommodated in the respective lateral panelling of the rear passenger compartment. With opened doors the backrests will fold forward without pressing the buttons.

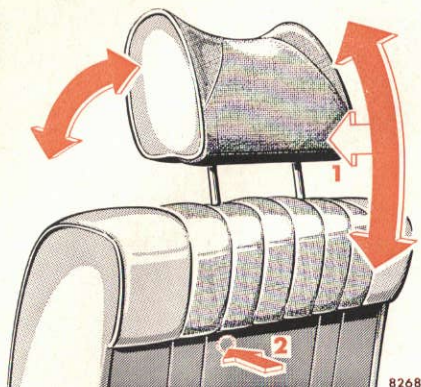

Safety Headrest

Adjust headrest to support the back of your head. For height adjustment or for removal, push headrest slightly forward (1).

To detach the headrest, release arrester by depressing a button (2) to be felt under the backrest covering material.

Safety Belts

Belt interlock system

The engine can be started only, if the safety belts of the occupied front seats are fastened correctly.

Safety belt warning system

The warning system (consisting of a warning light and a buzzer) is triggered

- while starting, if the front seat belts are not fastened correctly

- if the belts are unfastened while the ignition is switched on and the gear is shifted.

The right front seat contains a weight detector which is designed to activate the buzzer and warning light whenever a nominal weight is placed on the seat. The weight detector cannot distinguish between a passenger and any item of luggage or cargo, therefore, such items should be placed elsewhere in the car, preferably in the trunk.

Seats

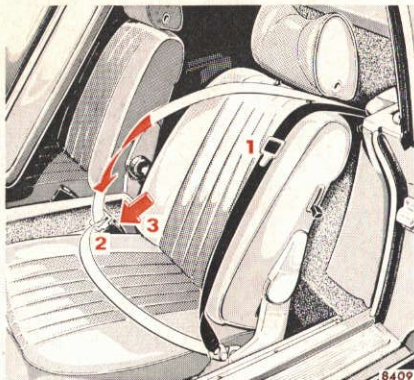

450 SL

Fastening of front and rear seat belts (with inertia reel):

- Pull belt with tongue (1) across shoulder and lap. The belt must not be twisted and must be tight.
- Press tongue (1) into buckle (2) and allow to engage audibly.

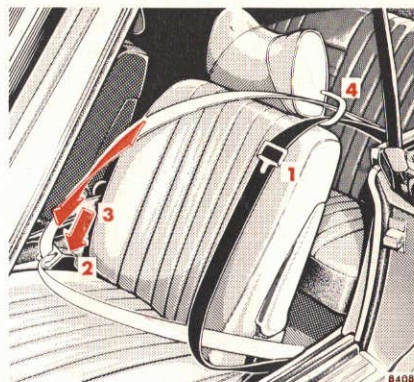

450 SLC

Unfasten, front and rear:

- Depress red button "PRESS" (3) in buckle (2).
- Return tongue (1) to initial position.

450 SLC: On entering or leaving the rear passenger compartment, the safety belt must be disengaged from guide (4).

Operation:

The safety belt inertia reel stops the belt unwinding further in case of vehicle deceleration in any direction or if the belt is pulled out quickly.

Functional test:

The locking function of the inertia reel can be tested by braking, negotiating a bend or by pulling the belt out quickly.

Note:

No safety belt can be used for more than one person. Belts are not intended for children (below the age of 6).

After an accident or in case of substantial damage to the webbing, the safety belts being used must be replaced. The belt anchors in the vehicle must be checked.

No modifications which affect the efficiency of the belt must be made. If in doubt, please ask at your MERCEDES-BENZ service station.

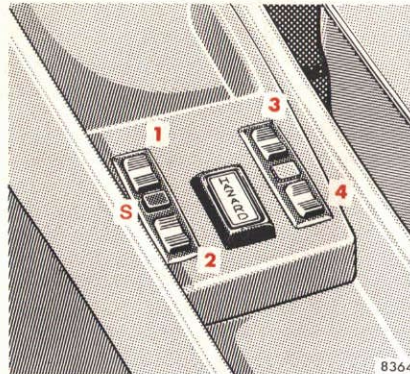

Electric Window Lifters

Switch group for window lifters:

- 1 front, left
- 2 rear, left
- 3 front, right
- 4 rear, right
- S Safety switch

Steering lock key in position "2".
The side windows can be operated as follows:

1. By depressing one of the switches 1-4 (one for each



window) comprising a switch group located forward of the oddments tray.

2. By actuation of the individual switches (5) under each rear side window. If safety switch (S) is not depressed, inadvertent operation of the rear windows (e. g. by children) is prevented.

When the ignition switch is turned off, the windows cannot be operated.

Instruments and Controls

- | | | |
|---|------------------------|---|
| 1 Movable nozzles | } For side ventilation | 14 Switch for heated rear window |
| 2 Control levers | | 15 450 SLC: Control for electrically operated sliding roof |
| 3 Parking brake release button
(Not applicable for right-hand drive vehicles) | | 16 Radio |
| 4 Light switch | | 17 Blower switch |
| 5 Combination switch | | 18 Automatic cruise control |
| 6 Hood release lever | | 19 Heating and ventilation |
| 7 Parking brake pedal ¹ | | 20 Seat belt warning |
| 8 Control knob for windshield washer system
When in operation, the windshield wipers are also activated | | 21 Temperature control for air conditioner |
| 9 Horn control | | 22 450 SLC: Loudspeaker – fader control |
| 10 Steering lock with ignition/starter switch | | 23 Ashtray with lighter |
| 11 Swivelling elements of fresh air outlet | | 24 Hazard warning flasher switch |
| 12 450 SLC: Toggle switch for rear dome light | | 25 Glove compartment handle
(push sideways to open) |
| 13 Fresh air control lever | | 26 Loudspeaker cover, right and left |

¹ With right-hand drive vehicles, a hand lever brake has been arranged between the seats.

Instruments and Controls

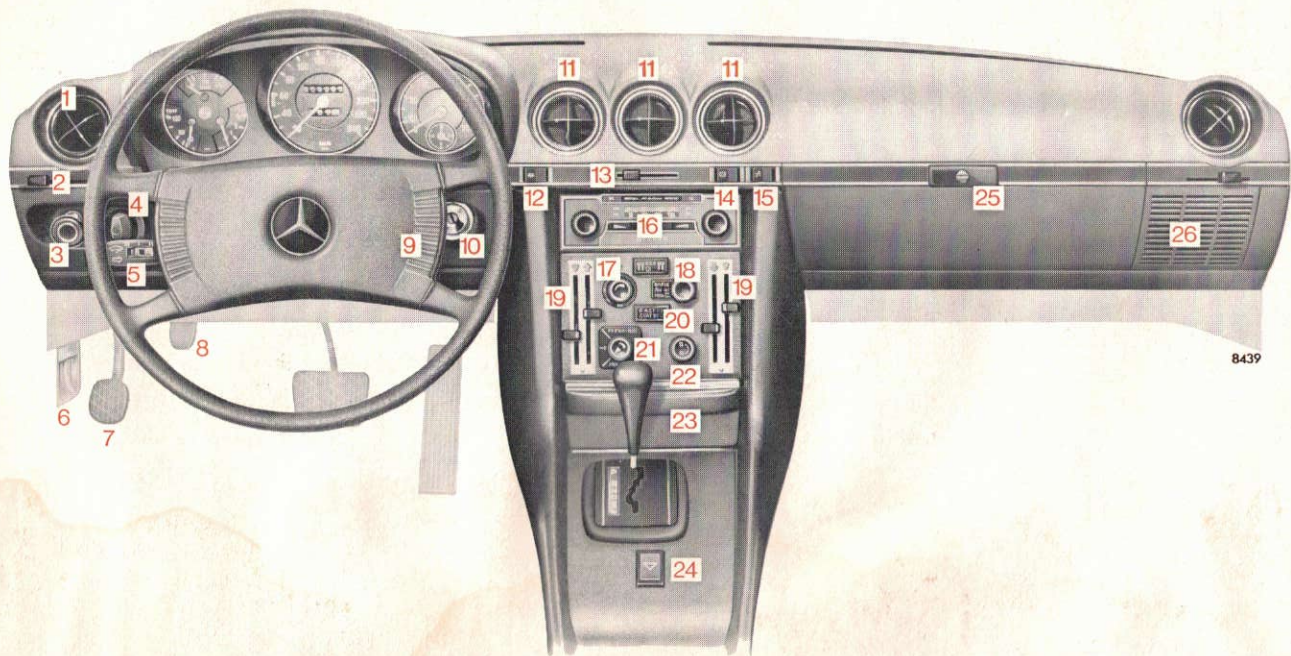

Instruments and Controls

Instrument Cluster, Speedometer, Tachometer, Clock, Indicator Lights

- 1** Cooling water temperature gauge ($^{\circ}$ F)
Red mark: max. permissible temperature
- 2** Fuel gauge with reserve warning light (red)
Fuel reserve for approximately
22–25 miles (35–40 km)
- 3** Oil pressure gauge
- 4** Total odometer
- 5** Trip odometer
- 6** Tachometer
- 7** Red mark on tachometer:
Maximum permissible engine revolutions,
do not exceed a maximum of 5,800 rpm
- 8** Knob for clock pointers
(press in for adjustments)
- 9** Electric clock
- 10** Turn signal indicator light, right (green)
- 11** Dimmer knob for instrument lighting,
continuous adjustment
- 12** Resetting knob for trip odometer
(push button)
- 13** Brake warning light (red):
Comes on when the parking brake is engaged
or when the brake fluid level in the
reservoir is too low
- 14** High beam indicator light (blue)
- 15** Charging indicator light (red):
Lights when the key in the steering lock is
switched to driving position “2” and must go
out when the engine is idling
- 16** Turn signal indicator light, left (green)

Instruments and Controls

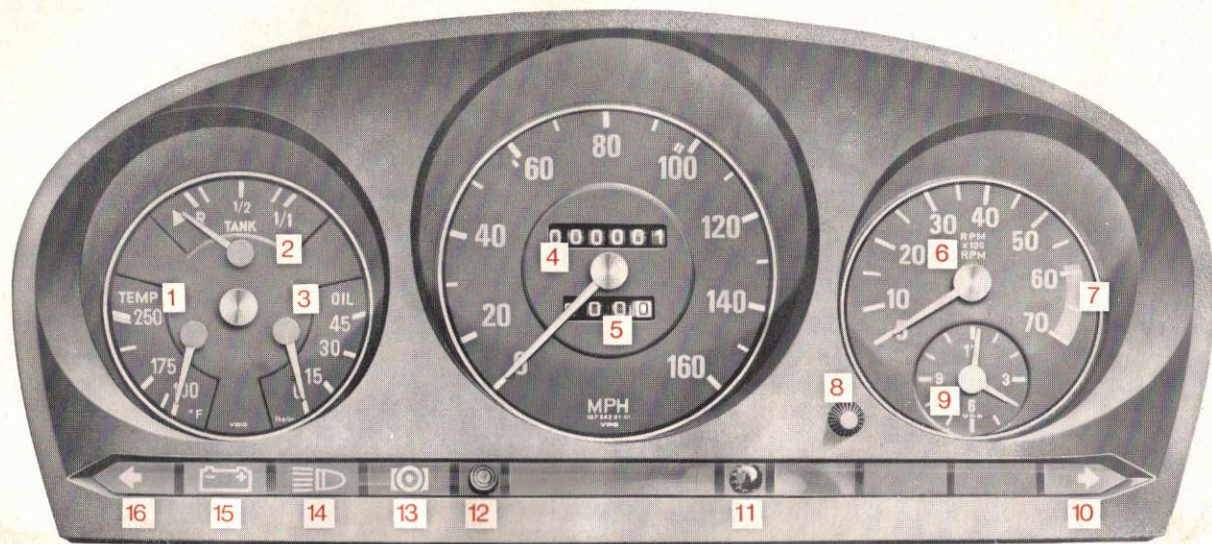

8443

Instruments and Controls

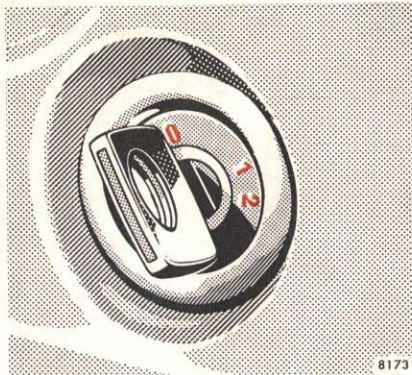

Steering Lock

0 Off position: When the key is withdrawn the steering is locked. The lights can be switched on. The key can be removed only in this position.

2 Driving: The steering is unlocked. (When turning the key clockwise to position "2", slightly move the steering wheel, if required.) The red charging control light comes on.

Power supply to standing lights is cut off.

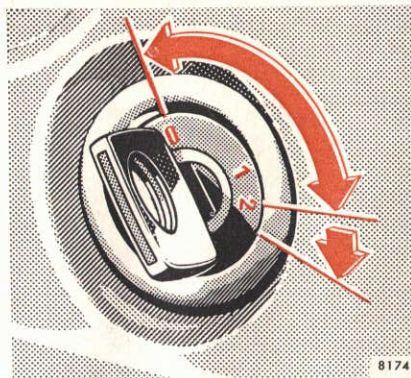

Starting position:

Turn key clockwise to the stop. The starter is engaged as long as the key is held up to the stop. Due to the installed starter tripping relay, the key must be returned to position "0" before making another starting attempt.

With the key in position "1", the steering is unlocked. The radio can be switched on.

A warning buzzer sounds when the key has been left in the lock and the driver's door is opened.



Light Switch

- 0 Off-position
- 1 Parking lights (includes side marker lights, tail lights, license plate lights, instrument panel lights)
- 2 Same as pos. 1 plus headlights
- 3 Standing lights, right
- 4 Standing lights, left
- A Turn to position 2 and pull out to first detent = same as position 2 plus fog lights
- B Available for an optional extra

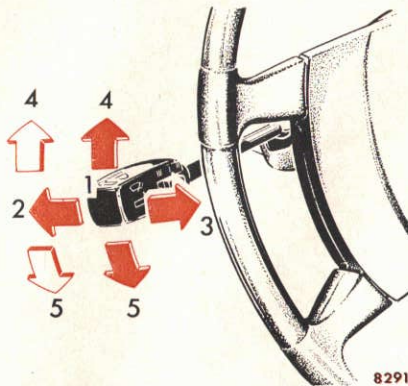

Combination Switch

- 1 Low beam (light switch turned clockwise to 2nd notch)
- 2 High beam (light switch turned clockwise to 2nd notch)
- 3 Headlight flasher (high beam available independent from light switch position)
- 4 Turn signals, right
- 5 Turn signals, left

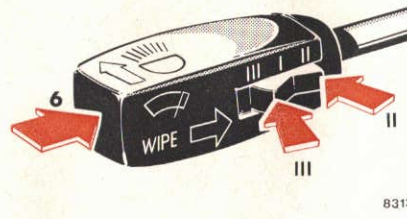

- 6 Windshield wiper (push button to switch on, push once more to switch off)
 - I Normal wiper speed (center position)
 - II Fast wiper speed (toggle switch pressed to the right)
 - III Intermittent wiping (depress left side of toggle switch = on, independent of button 6)

Hints

For brief signalling, such as changing lanes on an expressway, tip switch until resistance is felt and hold it there. The switch will return to the neutral position when released. In a normal turning situation such as turning a corner, press switch beyond resistance. The turn signal is cancelled automatically after the turn is completed.

The toggle switch automatically returns to position "I" when the windshield wiper is switched off.

Fog lights will only operate together with low beam headlights. Fog lights are turned off automatically when light switch is returned to off-position.

Heating and Ventilation

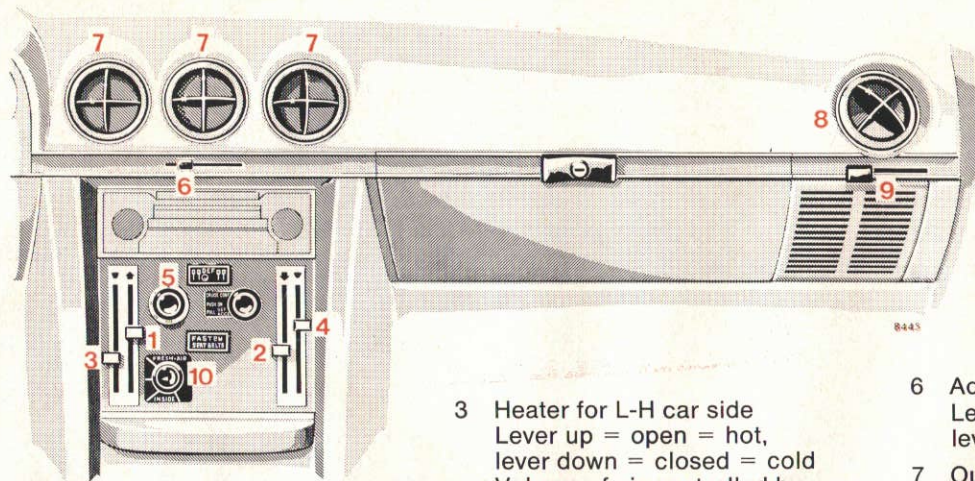

- 1 Air to windshield
Lever up = open,
lever down = closed
- 2 Air to leg space
Lever down = open,
lever up = closed

IS

- 3 Heater for L-H car side
Lever up = open = hot,
lever down = closed = cold
Volume of air controlled by
levers 1, 2 and 9
- 4 Heater for R-H car side
Lever up = open = hot,
lever down = closed = cold
Volume of air controlled by
levers 1, 2 and 9
- 5 Blower switch (4-speed)
To switch on, turn right

- 6 Additional fresh air
Lever to the left = open,
lever to the right = closed
- 7 Outlets for additional fresh air
Vaness tiltable
- 8 Side ventilation outlets
Eyeballs swivel
- 9 Lever for side ventilation
Lever inwards = open,
lever outwards = closed
- 10 Temperature switch for air
conditioner

Heating and Ventilation

The fresh air intake is located in front of the windshield (cowl) and should be kept free of snow.

The fresh air supplied to the interior of the car is infinitely variable with fresh air volume control levers 1, 2 and 9. Levers 3 and 4 control the heating of this air. Additional non-heated fresh air is available by moving lever 6. A continuous draft-free flow of air is supplied through indirect door ventilation even when all the levers are in position "closed".

Turn on the blower with rotary switch 5 to heat or ventilate the stationary vehicle or if an insufficient volume of air is available during the ride. We recommend using speed 2 for town operation and speed 1 for speedy touring.

450 SLC and 450 SL with coupé hardtop: When the windows are closed, the air escapes through the vents below the rear window. Take care that the vent openings are not covered by clothes etc.

Draft-free ventilation and heating:

Open lever 1 for about $\frac{1}{3}$ of its travel, lever 2 completely and lever 9 for about half of its travel (slightly swing eyeballs 8 outwards). Turn blower switch 5 to low speed.

Defrosting windshield:

Turn levers 1, 2, 3 and 4 upward and blower to full speed with rotary switch 5 (mark DEF). To defrost the side windows, in addition to the above adjustments, move lever 9 inwards and swing eyeballs 8 to point to the side windows.

Air Conditioning System

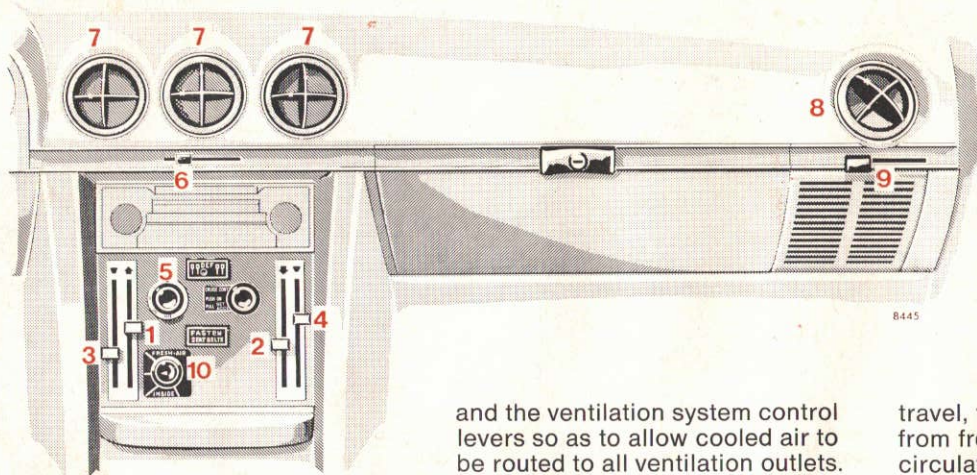

The temperature in the car can be lowered by combining the effects of the air conditioning and ventilating systems.

After engaging temperature switch 10, the air is conducted through an evaporator and thus cooled and simultaneously dehydrated. The air volume controlled by the blower

and the ventilation system control levers so as to allow cooled air to be routed to all ventilation outlets.

The air conditioner is operational only if the engine is running. High engine speeds correspond to high compressor speeds and thus mean increased cooling effect.

10 Temperature switch. Switch on by turning to the right. The cooling effect increases infinitely until the switch reaches the stop. After $\frac{3}{4}$ of the switch

travel, the system changes over from fresh air (FRESH-AIR) to circulation air (INSIDE) with a minor proportion of fresh air.

When the temperature switch is engaged, the blower speed is simultaneously cut down. We also recommend the application of a higher blower speed with increasing cooling effect (switch 5).

Rapid cooling:

- Fully turn on temperature switch and blower.
- Shift air volume control levers 1, 2, 6 and 9 to position "open" and heater control levers 3 and 4 to position "closed".
- Close side windows completely. (Hot air inside can first be evacuated by briefly driving with the side windows down.)

To reduce the cooling effect:

Rotate blower and temperature switches to the left.

Windshield fogging on the outside:

The windshield outside may fog during relatively damp weather. In

this case, shift downwards air volume control lever 1 to supply less cooled air to the windshield.

Mist on inner sides of windows:

In damp weather the air conditioner may be switched on in addition to the heater. By doing so, the moisture is extracted by the evaporator either from the fresh air or from the circulating air, depending on the setting of temperature switch 10. This cooled-down air may then be reheated to a pleasant temperature by positioning heater control levers 3 and 4 accordingly. This action quickly dries up the windows.

Important!

In order to maintain the air conditioning system in good working order, it is necessary to operate the system for a brief period at least once a month. This includes the seasons when it is normally not in use. To avoid annoying cold air, switch the blower to first speed only.

Various Equipment

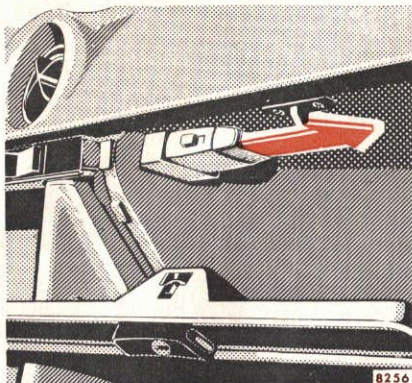

Interior Lights

The glove compartment light can be pulled out and be used as a flashlight. When relocated, it will recharge automatically.

The footwell lights below the instrument panel are switched on as long as one of the doors is open.

450 SLC: The switch of the forward dome light has 3 positions.

Position I: light is switched on and off by the door contact switches.

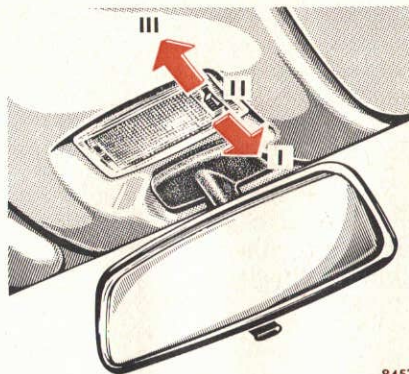

Position II: light is continuously switched off.

Position III: light is continuously switched on.

The rear dome light is switched on and off by means of the toggle switch on the instrument panel.

Sun Visor

Swing sun visor down to protect against sun dazzle. If sun light

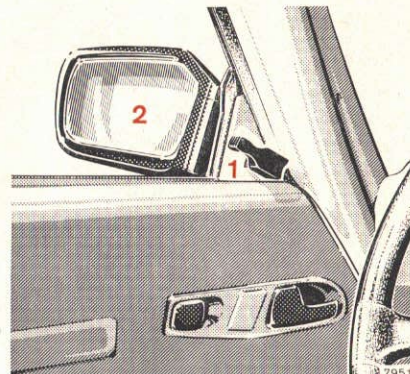

enters through the side windows, disengage visor from inner mounting and swing aside.

Rear View Mirrors

Outside: Outside rear view mirror (2) can be randomly adjusted by means of lever (1).

Inside: Mirror housing can be randomly adjusted. In addition mirror proper can be tilted by means of lever on lower mirror edge. Lever in opposite driving direction = normal position. Lever in driving direction = anti-dazzle position.

Various Equipment

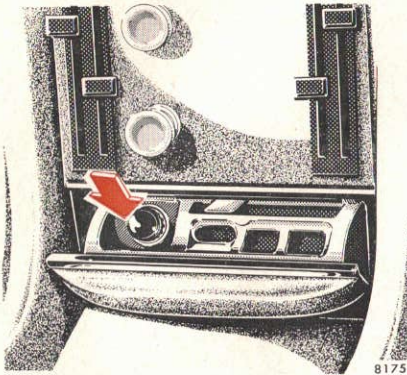

Lighter

Push the lighter in to heat it. It will pop out as soon as the filament glows.

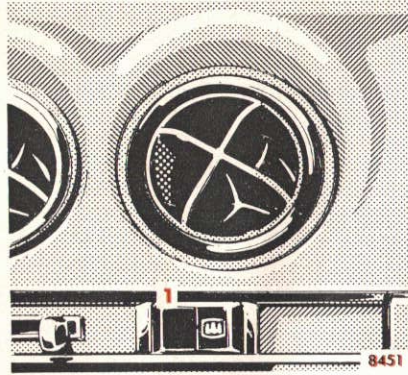

Heated Rear Window

Turn key in steering lock to position "2".

When the rear window heater is engaged, the white indicator light in the switch (1) comes on.

A heavy load is imposed on the battery due to the high power requirement. For this reason, switch off the heated rear window as soon as it is demisted or defrosted. It is cut out automatically after 30 minutes at the latest. First of all, however, clear heavy layers of ice or snow.

Radio

Operating instructions for the radio are in a separate brochure included with the manual.

The radio can be operated only if the steering lock is in position "1" or "2".

Power antenna

The power antenna will extend automatically as soon as the radio is turned on. If the radio is turned off or the steering lock is returned to position "0", the antenna will retract automatically.

450 SLC: Fader control knob

The fader control knob, located on the center console, controls infinitely the balance between the front and rear speakers.

To increase volume on the front speakers, turn control knob counterclockwise. To increase volume on the rear speakers, turn control knob clockwise.

Roadster Top

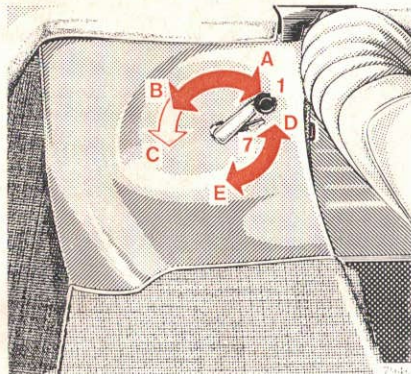

If possible, park vehicle in the shade as continuous exposure to sun rays will harm canvas color and rubber coating.

To lower or raise the folding top or to remove or attach the coupé hardtop, find two locking handles in a bag stowed in the glove compartment. They are used to engage or disengage locks (4). Put locking handles back into the glove compartment after use.

Lowering the roadster top:

A wet or frozen canvas top must not be folded.

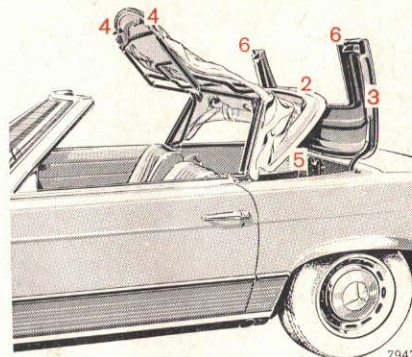

1. Unlock top bow (2) and top storage compartment cover (3) by shifting lever (1) to position C. Lever will automatically return to position B (bow remains unlocked but the top storage compartment cover can be locked). If the top bow cannot be raised in this position, shift lever (7) to position E.
2. Lift up top bow.
3. Open top storage compartment cover (3).

4. Disengage top framework by turning locks (4) inwards. Then detach locking handles.
5. Swing back top framework and slip top into top storage compartment (5). Stow overhanging canvas in the storage compartment.
6. Close top storage compartment cover, making sure that both ends snap in (6).

Raising the roadster top:

1. Move lever (1) to position C and open top storage compartment cover (3).
2. Pull top out of storage compartment and rest top framework against windshield header bar.
3. Tighten top framework by turning locks (4) outwards.
4. Close top storage compartment cover, making sure that both ends snap in (6).
5. Move downwards top bow until it locks and tighten with lever (1) (position A).

Coupé Hardtop

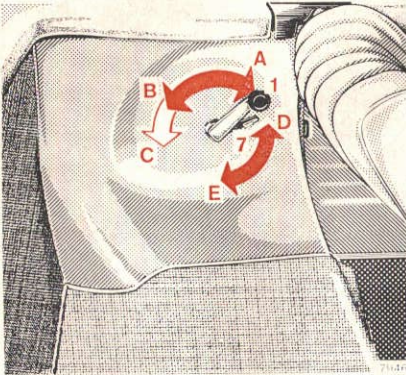

Removal or attachment of the coupé hardtop is best done in a MERCEDES-BENZ service station, although this can be carried out by 2 persons. The roadster top must be completely dry before it is placed in the storage compartment.

To lower or raise the folding top or to remove or attach the coupé hardtop, find two locking handles in a bag stowed in the glove compartment. They are used to engage or disengage the locks in windshield header bar and behind the doors (8). Put locking handles back into the glove compartment after use.

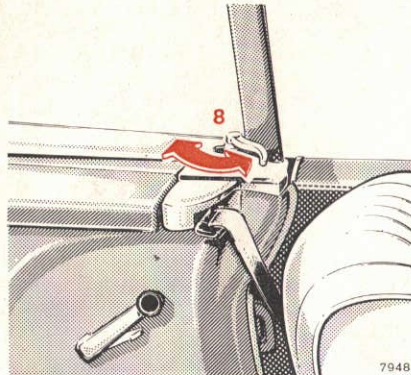

The coupé top is secured at 5 attachment points:

Front = two locks in windshield header bar

Side = one lock behind each door (8)

Rear = top bow lock

Removal of coupé hardtop:

1. Disengage rear locks with levers (1 and 7).
(Lever 1 in position B, lever 7 in position E.)
2. Turn side locks (8) rearwards to the stop with locking handles.

3. Insert locking handles into windshield header bar locks and swivel inwards.
Detach locking handles.
4. Disconnect plug and socket of the heated rear window in the R-H rear passenger compartment.
5. Cautiously detach coupé hardtop by removing it to the rear.

Attaching coupé hardtop:

1. Shift lever (1) to position B and lever (7) to position D.
2. Carefully position coupé hardtop, simultaneously inserting all locking pins into the respective locks.
3. Insert both the locking handles into the forward locks and swing outwards.
4. Insert locking handles into side locks (8) and swivel forward to the stop.
5. Push lever (1) to position A.
6. Connect plug and socket of the heated rear window in the R-H rear passenger compartment.

Coupé Hardtop

The roadster top may become moldy if it is kept enclosed in the storage compartment for an extended period. We recommend you to have the roadster top removed in a MERCEDES-BENZ service station if you intend to drive only with the coupé hardtop for a lengthy period. Should the roadster top, however, be kept in the car, unfold and air it thoroughly (do not expose to the sun) at regular intervals during the wet and cold seasons.

A special container for the storage of roadster tops or coupé hardtops is available from your MERCEDES-BENZ service station.

Sliding Roof (450 SLC)

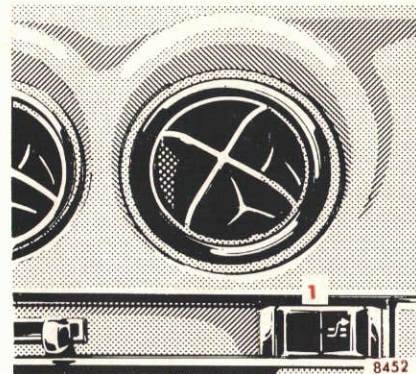

Toggle switch (1) next to glove compartment.

Push at the right (symbol) =
Opening

Push at the left = Closing

If the electric drive fails, the sliding roof can also be moved by hand. Refer to "Electrical System".

Driving

Hood

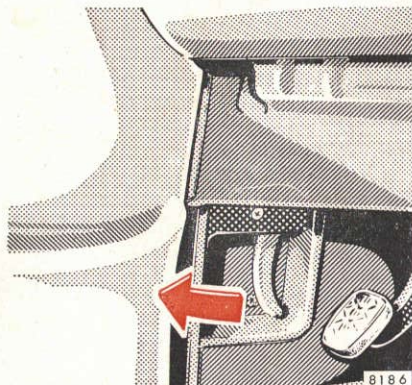

To open, pull handle (below the L-H side of instrument panel) to unlock it. The hood opens to the safety catch stop. Pull lever in radiator grille as indicated by the

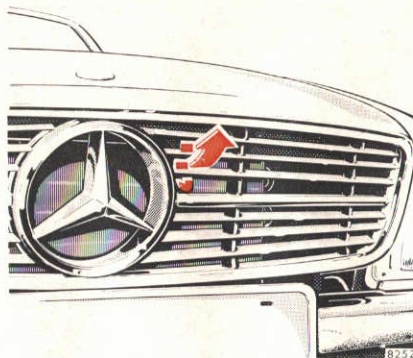

arrow and lift hood (windshield wiper arms must not be folded out). To close, press down hood firmly.

Parking Brake

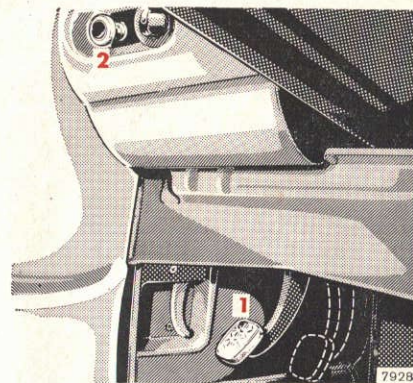

Press the parking brake pedal (1) down to the farthest possible catch. When the steering lock key is in position "2", the brake warning light in the instrument cluster comes on.

To release, pull release button (2) on the instrument panel. The parking brake releases in one rapid movement. The parking brake warning light in the instrument cluster must go out.

Have the following items checked regularly and prior to any long trip

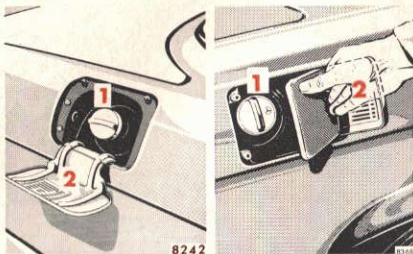

Fuel Supply 1

Use gasoline, for octane rating see "Fuels, Coolants, Lubricants, etc.". Do not force fuel tank flap.

Tire Pressure 2

Find the tire inflation pressure table in the fuel filler flap. Check at least once a week. For more details see "Wheels, Tires, Changing Wheels".

Engine Oil Level 3 Automatic Transmission Fluid Level

See "Checking Fuels, Coolants, Lubricants, etc." and "Fuels, Coolants, Lubricants, etc.".

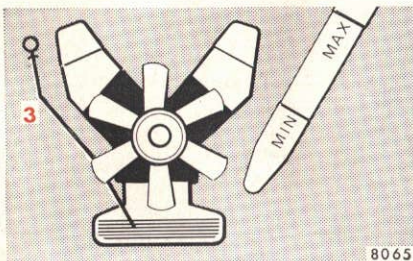

Cooling Water Level 4

See "Checking Fuels, Coolants, Lubricants, etc." and "Fuels, Coolants, Lubricants, etc.".

Brake Fluid 5

When the minimum mark on the reservoir is reached, have the system checked (brake lining thickness, leaks).

Windshield Washer 6

Replenish with water mixed with MERCEDES-BENZ windshield washer detergent (container is in the engine compartment). Adhere to the mixing ratio printed on the package.

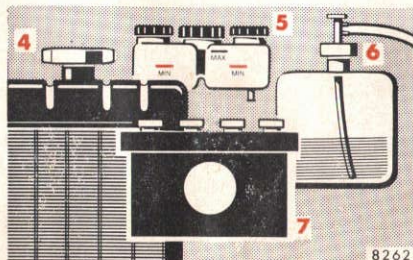

Battery 7

Replenish only with distilled water up to the markings in the cells. See "Electrical System".

Vehicle Lighting

Check for function and cleanliness.

Starting and Turning off the Engine

Place the gear selector lever in either "P" or "N" position before starting the engine.

Engage parking brake or service brake.

Turn steering lock key to driving position "2". Red charging control light must come on.

The engine can be started only, if the safety belts of the occupied front seats are fastened correctly.

Cold Engine

Do not depress accelerator pedal before cranking engine. Turn ignition key clockwise to the stop. Slowly depress accelerator pedal when the engine starts firing. Release ignition key only when the engine runs smoothly.

Warm Engine

On a warmed or hot engine depress accelerator pedal fully while cranking the engine.

If the engine has not started after about 10 seconds, discontinue starting and return the ignition key to position "0". Starting can be repeated after a 30 second break.

After the start, briefly speed up the engine and then ease off the accelerator to prevent the engine racing.

Hints

Observe oil pressure gauge right after starting. Oil pressure in a very cold engine will rise only gradually and some time after starting. In the narrow oil pressure gauge line the pressure rise will only gradually become effective. Do not speed up engine in the stationary vehicle before pressure is indicated on the oil pressure gauge. The charging control light must go out as soon as the engine is operating.

For starting at low ambient temperatures see "Winter Driving" and "Starting at Low Ambient Temperatures".

Turning off

Turn key in steering lock to position "0" and remove only when the vehicle is at a standstill. Move selector lever to position "P" or "N".

With very high coolant temperatures (e. g. after hard driving on steep inclines), do not shut off the engine at once but allow to run at slightly increased idle speed for approximately 1–2 minutes.

Test service brake after driving off. Warm the engine smoothly. Do not place full load on the engine until the operating temperature has been reached.

The automatic transmission facilitates and simplifies the handling of the vehicle. The individual gears are shifted automatically dependent upon selector lever position, vehicle speed and accelerator position.

Hint

If repairs are carried out on the vehicle with the engine running, depress the parking brake pedal to the last possible notch and shift selector lever to position "P".

Starting

Shift selector lever to the desired driving position only when the engine is idling and the service brake is applied. Do not release the brake before moving off. The vehicle may otherwise start creeping when the selector lever is in a driving position.

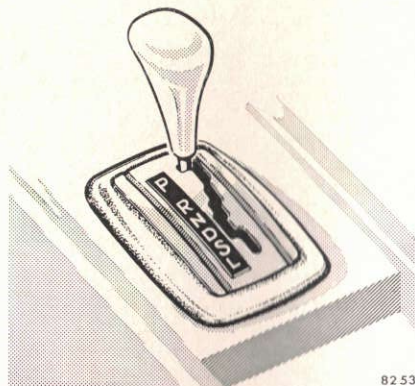

Accelerator position

Partial throttle = early upshifting
= normal acceleration

Full throttle = retarded upshifting
= maximum acceleration

Depressing the accelerator beyond full throttle to kickdown position means downshifting to the next lower gear and thus maximum acceleration. If you ease up on the accelerator after having attained the desired speed, the transmission will shift up again.

Starting and Shifting Gears

Selector Lever Positions

The automatic gear shifting process can be adapted to specific operating conditions by means of the selector lever.

"P" Parking lock. The parking lock is an additional safeguard when parking the vehicle. Engage only when the car is stationary.

"R" Reverse gear. Shift reverse gear only with the vehicle at halt.

"N" Neutral. No power is transmitted from the engine to the rear axle. When the brakes are released, the vehicle can coast freely (to be pushed, towed or tow-started). Do not shift to neutral while driving.

"D" Drive. Normal driving position. All three gears are shifted automatically and consecutively. Position "D" offers optimum driving characteristics in almost all operating conditions.

"S" Slope. Transmission is shifted up to 2nd gear only. Suitable for moderate ascents and de-

Starting and Shifting Gears

scents. As the transmission is shifted up to 2nd gear only, this position permits the utilization of the engine braking effect. If the selector lever is in position "S", upshifting from 1st to 2nd gear will take place later than with the selector lever in position "D". Shifting the selector lever down from "D" to "S" is admissible only below the permissible top speed (two-line marking on speedometer).

"L" Low. Transmission will not shift up. For driving on steep grades and for trailer operation in the mountains. Observe maximum speed (one-line marking on speedometer).

Stop and go traffic

Shift selector lever to driving position "L" in slow bumper to bumper traffic with frequent stops.

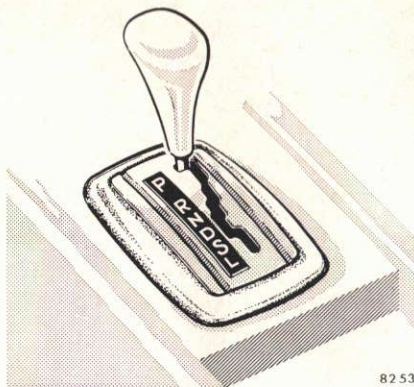

82 53

Maneuvering

To maneuver in restricted area, e. g. when pulling into a parking space, control the car speed by gradually releasing the service brake. Accelerate gently and do not pump the accelerator. To rock a car out of soft ground (mud or snow), alternately shift one forward gear range and the reverse gear at partial throttle.

Trailer operation

Do not allow the engine speed to drop to low at uphill gradients to prevent the engine from laboring at low RPMs. Depending on the degree of the incline, shift selector lever to positions "S" or "L" early enough to maintain engine rpm's within best torque range.

Stopping

For brief halts, e. g. at traffic lights, leave the selector lever in a driving position and control vehicle with the service brake.

For longer stops with the engine idling, shift selector lever to position "N".

When stopping the car on a slope, do not hold it by means of the accelerator but use the brake. This avoids superfluous heating of the transmission.

Always drive in compliance with the "Safety first" principle. The car's comfort can easily tempt you to underestimate the speed at which you are actually traveling. Condition yourself into keeping an eye on the speedometer needle, for high speeds demand increased stopping distance.

The more slippery and wet the road surface and the higher the speed, the easier the tires lose their anti-skid properties.

Decelerate, brake sensibly and avoid locking the wheels.

Do not allow your tires to wear down too far. With less than 0.118 in. (3 mm) of tread the nonskid properties of the tires are considerably reduced on a wet road.

We recommend using studded tires on ice or snow. They will cut down the stopping distance as compared to summer tires. Stopping distance is nevertheless still long in comparison with when the road is dry or wet.

On long and steep descents, ease the load on the brakes by downshifting (shift selector lever to position "S" or "L").

After hard braking it is advisable not to switch off the engine right away but to drive on for some time so the air stream will cool down the brakes faster.

After driving in heavy rain for an extended period without the application of the brakes, the braking effect may be found to be slightly delayed and the brake pedal may have to be depressed harder. In the event of a downpour, keep greater distance between you and the vehicle traveling in front of you.

Once in a while check the effectiveness of the system by fully applying the brakes on an open road (make sure the wheels will not lock). This will also improve the grip of the linings.

Fuel Consumption

Fuel consumption very much depends upon individual driving habits and operating conditions. Extremely low ambient temperatures, operation in city traffic, driving over short distances or in hilly terrain, frequent acceleration and deceleration, etc. will result in increased fuel consumption. It is also increased when optional units are installed.

Engine Oil Consumption

Engine oil consumption can only be determined after a certain mileage has been covered. During the break-in period, higher oil consumption may be noticed and is normal. Frequent high engine speed operation will also cause increased oil consumption.

Safe Driving Braking

Brake Warning Light

If the brake warning light in the instrument cluster comes on although the parking brake is released, this indicates a low fluid level in the brake fluid reservoir.

Have the brake system checked in a MERCEDES-BENZ service station immediately.

Brake lining wear can be the cause of brake fluid shortage in the reservoir. Only install replacement brake linings recommended by us for the respective axles in pairs.

Charge Indicator

If the charge indicator will not go out after the engine has been started or if it comes on during operation, the alternator is defective and must be repaired in a MERCEDES-BENZ service station at once.

Oil Pressure Gauge

The oil pressure may drop at idle speed to 7.1 psi (0.5 kp/sq. cm) if the engine is at operating temperature. This will not jeopardize its operational reliability. Pressure must, however, rise immediately upon acceleration.

Temperature Gauge

On account of the pressurized cooling system the cooling water will boil only at approximately 244° F (118° C).

At high ambient temperatures and when the vehicle is driven on mountain roads, the cooling water temperature may rise to 239° F (115° C).

Tachometer

The red marking on the tachometer is the engine overspeed range.

Do not exceed a maximum of 5,800 rpm. The engine generates maximum torque at 3,000 rpm.

Emission Control

Special devices of the engine and/or adjustments serve to keep the toxic components of the exhaust gases within permissible limits required by law. (Nevertheless, we urgently advise you not to let the engine run in a closed garage, because in such cases the danger of carbon monoxide poisoning still exists.) These devices, of course, will function properly only when maintained strictly according to factory specifications. Any adjustments on the engine should, therefore, be carried out only by qualified MERCEDES-BENZ technicians. The devices must not be disconnected or removed nor the adjustments be altered in any way. Moreover, the specified service and maintenance jobs must be carried out regularly according to MERCEDES-BENZ servicing requirements. These service and maintenance jobs particularly require the checking of the carbon monoxide content, the adjustment of the engine idling speed and distributor timing. For details refer to emission systems manual.

Safe Driving Braking

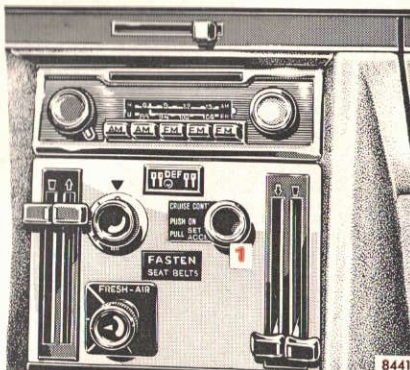

Cruise Control

Any given speed above approximately 30 mph may be maintained automatically by setting the Cruise Control system.

Automatic operation

"ON"

Before setting the system, it is required to activate it by pushing the control button (1) in.

"SET"

System may then be set to the desired speed by a brief pulling of the control button.

"ACCEL"

To raise the desired speed level (accelerate), pull control button continuously until new speed has been reached, then release button.

Speed level may also be raised by accelerating with gas pedal, then setting new speed by briefly pulling on the control button.

In case no new speed setting is desired (e. g. after raising speed briefly for passing), do not pull button, but release accelerator and vehicle will decelerate to original speed setting which will then be maintained.

Cancelling operation

To cancel speed setting, slightly depress brake pedal. The automatic Cruise Control will be cancelled, but the system will not be deactivated.

Automatic Cruise Control will resume after re-setting speed.

The Cruise Control system as such, once activated, can only be deactivated by switching off the ignition.

The First 1,000 Miles

The more cautiously you treat your engine during the break-in period, the more satisfied will you be with its performance later on. Therefore, drive your vehicle during the first 1,000 miles (1,500 km) at varying vehicle and engine speeds.

During this period, avoid heavy loads (full throttle driving) and high RPMs (no more than $\frac{2}{3}$ of maximum permissible speed in each gear) and do not force the engine to labor at low engine speed.

Avoid accelerating to kickdown. It is not recommended to brake vehicle by means of manually shifting to a lower gear. We recommend to select positions "S" or "L" only at moderate speeds (for hill driving).

After 1,000 miles (1,500 km) speeds may gradually be increased to the permissible maximum.

Special Operating Conditions

Traveling Abroad

Abroad, too, there is a widely-spread MERCEDES-BENZ service network at your disposal. If you travel into areas which are not listed in the index of your service station booklet, you should request pertinent information from your dealer.

Winter Driving

Have your car winterized in a MERCEDES-BENZ service station before the onset of winter.

- Engine oil change: If no "year-round use" engine oil is used, fill with thin winter oil. For viscosity and capacity refer to "Fuels, Coolants, Lubricants, etc."
- Antifreeze in the cooling water: Check antifreeze protection periodically. For capacity refer to "Fuels, Coolants, Lubricants, etc."
- Additive in the windshield washer system: Add MB windshield washer solvent to the water in the windshield washer system.

- Test battery: Battery capacity drops with decreasing ambient temperature. A well charged battery ensures that the engine can always be started, even at low ambient temperatures.
- Tires: For the cold season we recommend M+SE radial tires on all wheels. Max. speed – 90 mph (150 km/h); however, maximum speed specified by the law must be observed.

Tire Chains

Tire chains are indispensable under unfavorable conditions (deep, freshly fallen snow on inclines).

Retighten newly mounted tire chains after a few miles of driving. Do not exceed permissible maximum speed of 40 mph (70 km/h). On clear roads, remove the chains as soon as practicable. Adhere to the manufacturer's mounting instructions.

Starting at Low Ambient Temperatures

When traveling short distances and at temperatures below +23° F (-5° C), increase engine idle speed before switching off and allow engine to run for a short while until a cooling water temperature of about +176° F (+80° C) is reached in order to keep the spark plugs clean for the next cold start.

At ambient temperatures below -4° F (-20° C), fully depress the accelerator three times prior to switching on the ignition.

Optional electrical heaters for installation in the cooling system are available for areas where extremely low ambient temperatures occur. They are connected to a suitable power source to heat the coolant in keep it warm.

Vehicle Care

MERCEDES-BENZ Maintenance System

Like any other technical equipment, the vehicle requires care and maintenance. Scope and frequency of maintenance work depend mainly on operating conditions which, in turn, may vary to a considerable degree.

A maintenance booklet is delivered with your car listing all the maintenance jobs that must be carried out after the following mileages:

- Once after 200 to 600 miles (300–1,000 km).
- Once after 5,000 miles (7,500 km).
- After 10,000 miles (15,000 km) and thereafter every 10,000 miles (15,000 km), but at least once a year.

We should also like to draw your attention to the hints contained in the maintenance booklet covering necessary lubrication services (every 5,000 miles – 7,500 km), additional maintenance jobs (every 30,000 miles – 45,000 km) and MB individual maintenance as required.

The vehicle must receive the prescribed maintenance and/or lubrication work at the specified intervals

as listed in the maintenance booklet. Verification of performance of such maintenance/lubrication work should be recorded in the spaces provided in the maintenance booklet.

The maintenance jobs are described in detail in a manual which you can order from your MERCEDES-BENZ service station.

A small sticker attached to the door post of the driver's door by the service station personnel is to remind you when the next maintenance service or lubrication service is due.



Maintenance service



Lubrication service

Severe Operating Conditions

In the case of rigorous operating conditions or heavy use mainly in city traffic or over short distances, frequent mountain driving, poor roads, dusty and muddy conditions, trailer operation, hard and sporty

driving, etc. it may be necessary to inspect e. g.

- the front axle brake linings
- the ignition system
- the tires

at shorter intervals.

Any MERCEDES-BENZ service station will be pleased to give you expert and individual advice.

Engine Oil Change and Oil Filter Service

Every 5,000 miles (7,500 km) or at least twice a year (spring and fall).

Under severe operating conditions, have an oil change every 2,000 to 2,500 miles (3,000–4,000 km) without filter service.

Automatic Transmission – Fluid Change and Filter Change

To be carried out every 30,000 miles (45,000 km) according to the maintenance booklet.

Under severe operating conditions, have the automatic transmission fluid changed every 12,000 to 15,000 miles (20,000–25,000 km) without filter change.

Cleaning and Care of the Vehicle

In operation, your car is subjected to many external effects which are harmful to body and underside. Besides the often rather inclement and alternating weather conditions, air pollution, thawing salts, tar, and flying gravel come into action.

Particularly unfavorable conditions, as for example in the vicinity of the ocean, in industrial areas (smoke, exhaust emissions), and in winter, may require specific preventive measures.

Have the car regularly inspected for damage caused by thrown up gravel or other mechanical influences. Damage should be repaired at the earliest possible date, particularly before the onset of the cold season.

We recommend you to repeat the standard body cavity preservation within the first year of operation.

We have selected car care products and compiled recommendations which particularly match our vehicles

and which are constantly kept up to date. MB car care products are available at any MERCEDES-BENZ service station.

Their correct application is a prerequisite for the recognition of potential guarantee claims.

Deep scratches, deposits of industrial dust, stains caused by exterior effects and other faults which must be blamed on neglected or incorrect maintenance can sometimes no longer be removed with products for routine care. In such cases it is best to rely on the skill of your MERCEDES-BENZ service station.

The following is a review of the most important car care services and includes information on recommended MB care products as well as hints on important details.

Insect Removal

MB Insect Remover

Apply before washing the car.

Car Wash

Add MB Autoshampoo to the Water

The car should be washed in the shade, not in the sun. Spray it with a dispersed jet of water. Direct only a very weak jet towards the ventilation intake. Use plenty of water and rinse sponge and chamois frequently. Rinse with clear water and leather chamois.

If your vehicle has been washed in an automatic car wash, reclean, if required, the tail light recesses designed to avoid soiling. This is particularly advisable with respect to older generation washing systems.

In winter thoroughly remove residual thawing salt as fast as possible.

When washing the car underbody, do not fail to clean the inner side of the rims.

Cleaning and Care of the Vehicle

Tar Stains

MB Tar Remover

Quickly remove tar stains before they dry.

Windows

MB Window Cleaner

Use for heavy and oily soiling of windows. Clean windshield wiper blades with clean cloth and washing solution, replace blades once or twice a year.

Plastic (Vinyl) and Rubber Parts

MB Autoshampoo as Washing Solution

Do not use any other solvents, do not oil or wax these parts.

Steering Wheel and Selector Lever

As Washing Solution Use MB Autoshampoo, Neutralized Dish-washing Detergent or Soft Detergent

Wipe with cloth moistened in lukewarm solution.
No scouring agents must be used.

Safety Belts

The webbing must not be treated with chemical cleansing agents but must be cleaned with clear lukewarm water and soap only.

Do not dry webbing at temperatures above 176° F (80° C) or in direct sun radiation. Never bleach or redye webbing.

Velours upholstery

MB Autoshampoo, MB Stain Remover

Pressure marks resulting from dampness and heat may appear to be stains. Such stains can be removed by wiping with a moistened brush, ironing with a wet cloth or by treating with dry shampoo. Do not sit on damp upholstery. Quick drying is achieved by applying hot air – e. g. by using a hair drier.

If in doubt, please consult your MERCEDES-BENZ service station.

Leather upholstery

MB Autoshampoo as Washing Solution

Wipe leather upholstery with a damp cloth and dry thoroughly. Exercise particular care when cleaning perforated leather as its underside must not become wet.

MB Leather Care

For care and antistatic protection.

Paintwork

MB Polish, MB Gloss Preserver

Do not apply when the car is parked in the sun or when the hood is still hot.

The paintwork should be treated with MB polish about every three months.

MB polish will also retain the gloss and allow the removal of minor scratches from wooden parts.

MB gloss preserver protects the paintwork and will retain the original shine.

Cleaning and Care of the Vehicle

MB Touch-up Stick or MB Touch-up Paint Spray

For quick and provisional repair of minor paint damage.

MB Polishing Compound

To polish up heavily dirtied or weathered paintwork or to remedy minor paint damage.

Garnish Moulding (Chromium-Plated, Aluminium)

MB Chrome Care, MB Chrome Cleaner

For regular cleaning and care of heavily soiled chromium-plated parts.

MB Chrome Protective Wax, MB Chrome Protective Lacquer

For spray preservation in winter.

Roadster Top

(Rubber-coated Canvas)

Stow only a completely dry top in the storage compartment. If the top is kept in the storage compartment for a lengthy period, unfold and air it well with the windows down from time to time.

Remove bird droppings immediately. The organic acid swells the rubber and causes the top to leak.

In general regular spraying or cleansing with clear water will do. Wash top only when heavily soiled, not every time the car is washed.

Caution: Never use any gasoline, thinner, tar and stain removers or similar organic solvents to clean top or rear window.

Dry cleaning:

Brush top (always from front to rear) with a soft-bristled brush.

Wet cleaning:

Brush the dry top. Wash with a mild detergent and an ample supply of lukewarm water by wiping the canvas with a soft-bristled brush or a sponge from front to rear. Then cleanse thoroughly with clear water.

If only parts of the top have been washed, wet the entire top at the end of the proceedings and allow the unfolded and tightened top to air-dry. Wipe the rear window with a cloth soaked with a detergent and rub dry. Do not use sharp-edged instruments for the removal of ice and snow.

Important!

The seams of the top may start to leak due to improper care and cleaning, as well as due to usage over a long period of time. A resealing of the top seams can be carried out at every MERCEDES-BENZ service station.



Practical Hints

Practical Hints

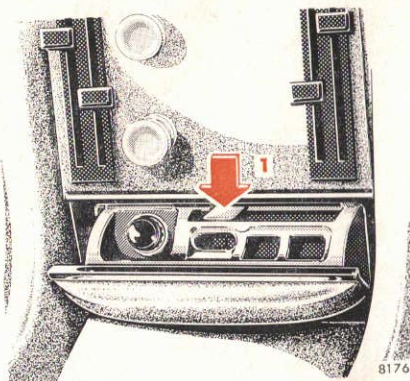

Ashtrays

Removal of front ashtray:
Pull out ashtray up to the stop.
Depress center locking spring (1)
and remove ashtray.

Removal of rear ashtray (450 SLC):
Press down ashtray when opening
it and remove it.

Installation, front and rear:
Position ashtray squarely and
push in.

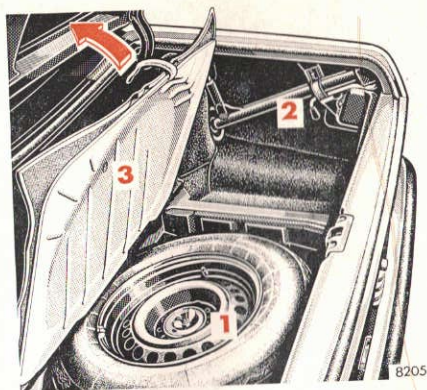

Vehicle Tool Kit

Spare wheel (1) is stowed in a
trough below the folding trunk
floor (3).

Jack (2) and tools are located
in the trunk on the right side.

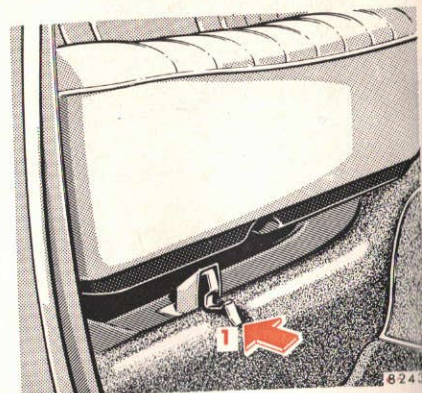

Rear Seat Cushion (450 SLC)

Removal: Push in left and right
spring clamps (1), slightly raise
rear seat cushion at the front side
and pull toward the front.

Installation:
Push rear end of rear seat cushion
under rear seat back as far as it
will go and press seat cushion front
section downward until it rests on
the cushion support.

Wheels Tires Changing Wheels

Wheels and Tires

See any MERCEDES-BENZ service station for information on tested and recommended tires for summer and winter operation. They will also offer more advice concerning tire service, repair and purchase.

For tires refer to "Technical Data".

Mount newly acquired single tires on the front axle. It is advisable to break in new tires over a mileage of approximately 120 miles (200 km) at moderate speeds.

Rotating wheels: the wheels can be rotated according to the degree of wear while retaining the same sense of rotation.

In terms of service life the retention of the same sense of rotation is of paramount importance on studded winter tires.

Caution: Use longer wheel bolts for light alloy disk wheels than those required for steel disk wheels (see illustration on page 48).

Thoroughly clean the inner side of the wheels any time you rotate the wheels or wash vehicle underside.

Check the wheel rims for damage at regular intervals. Dented, bent or corroded rims may cause pressure loss and damage to the tire beads. Have wheel rims derusted and repainted whenever the tire is replaced, at the latest, however, every other year.

Wheels Tires Changing Wheels

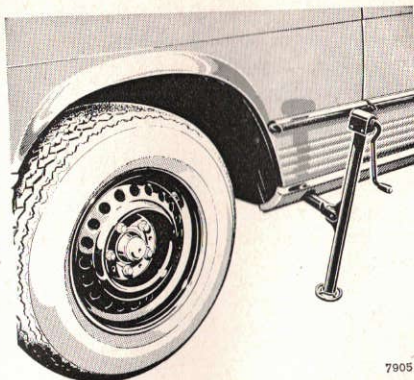
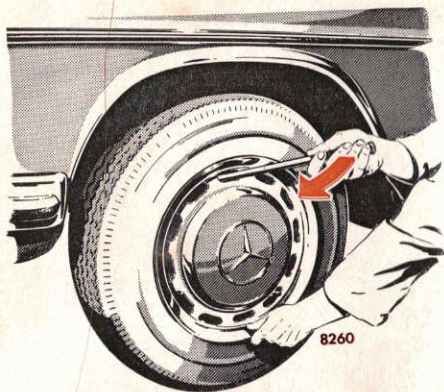

Changing Wheels

1. Engage parking brake firmly.
2. Move selector lever to position "P".
3. Safeguard vehicle against rolling off by using chocks or similar. Place chocks under both opposite wheels (on downhill side), on a level road on both sides of the opposite front wheel when changing a rear wheel.

4. Insert the combination wrench in one of the trim ring slots and lever off the hub cap.
5. Using the combination wrench, loosen but do not yet remove the wheel bolts.
6. If required, thoroughly clean the jack tubes on the vehicle. (Jack tubes are behind the front wheel houses and in front of the rear wheel houses.)
7. Insert jack arm into the tube hole up to the stop. Position the jack so that it will always be vertical

Observe wheel bolts!

- 1 For light alloy disk wheel only
- 2 For steel disk wheel only

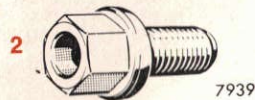

as seen from the side, even on inclines. Jack up the vehicle until the wheel is clear of the ground.

8. Then back out the wheel bolts. Protect bolt threads from dirt and sand. Remove the wheel.
9. Adjust the jack to allow the wheel to be slipped on without being lifted.
10. Slip on wheel (valve down) and press onto the wheel securing plate. Screw in wheel securing bolts but use only such bolts that suit the rim.

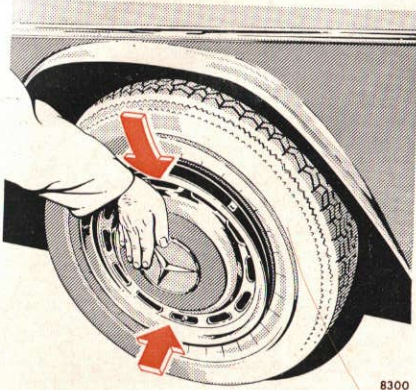

11. Lower car and remove jack. Tighten the five bolts evenly by going around the wheel and tightening every other bolt until all the bolts are tight. Observe a tightening torque of 72 ft. lbs. (10 mkp).

12. To install the wheel trim ring, first insert the valve into the center slot between the two trim ring securing clips and press the trim ring against the wheel flange at this point. Then rest the two opposite clips on the rim and seat the trim ring by firmly striking it towards the valve with the flat of the hand.
13. Rectify tire pressure.
14. Have damaged tires repaired immediately.

Tire Pressure

A table in the tank filler flap lists the tire pressure for radial and winter tires as well as for the varying operating conditions.

Tire pressures listed for light loads and low speeds are minimum values offering optimum driving comfort. Increased inflation pressures for heavy loads or higher speeds used with light loads produce favorable handling characteristics and are perfectly permissible. However, the ride of the vehicle will become somewhat harder.

Tire temperature and pressure increase with the vehicle speed. Tire pressure should therefore only be rectified on cold tires. Correct tire pressure in hot tires only if pressure has dropped below the data listed in the table and the respective operating conditions are taken into consideration.

Checking Fuels Coolants Lubricants etc.

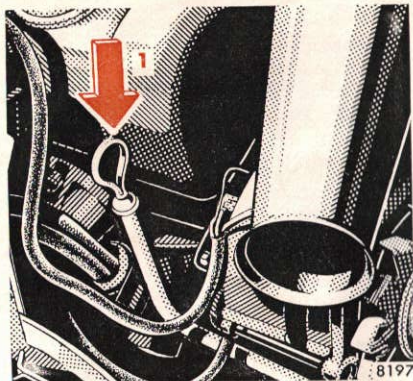

Engine Oil Level

After the engine has been shut off for a short period of time, check the oil level in the oil pan with the vehicle parked on level ground.

The oil level must be somewhere between the lower and upper dipstick mark (1); do not replenish in excess of the upper mark.

For viscosity and capacity see "Fuels, Coolants, Lubricants, etc."

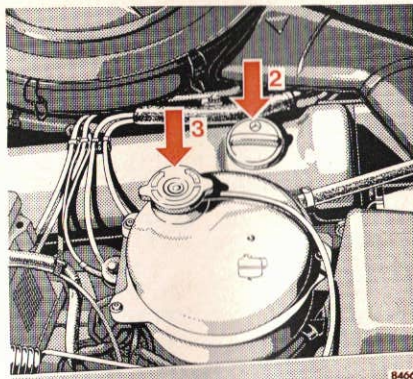

Coolant Level

The cooling water reservoir with filler neck is arranged in front of the battery away from the radiator. To replenish cooling water, the car must be on level ground.

Remove the cooling water reservoir cap only if the cooling water temperature is below 194° F (90° C). First turn cap to notch I to release excess pressure.

If the cap is removed immediately, hot water and steam will be ejected.

- 1 Dipstick
- 2 Replenishing engine oil
- 3 Replenishing coolant

To add cold water to a hot engine, it must be left idling. Hot water may be poured in with the engine cold or warm.

The coolant level must reach:

- the mark indicated on the reservoir when the coolant is cold.
- approximately 0.8" (2 cm) higher when the coolant is hot.

The coolant drain plugs are situated on the R-H and L-H engine side and on the radiator bottom.

For antifreeze and corrosion inhibitors see "Fuels, Coolants, Lubricants, etc."

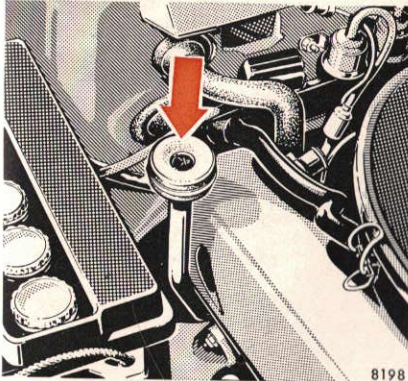

Automatic Transmission Fluid Level

If repairs are carried out on the vehicle with the engine running, depress the parking brake pedal to the last possible notch and shift selector lever to position "P".

At regular intervals, check the fluid level of the automatic transmission together with the engine oil level prior to every long trip, at the latest, however, after every 3,000 miles (5,000 km).

Check the fluid level with the engine idling, parking brake engaged and selector lever in position "P". The unloaded vehicle must be parked on level ground. Allow the engine to idle for approximately 1–2 minutes before checking.

Observe painstaking cleanliness. No woolen fabric must be used to wipe the dipstick (fluff), but select chamois leather. When replenishing fluid through the transmission dip-

stick hole, utilize a fine-mesh strainer. Even the least impurity may cause operational troubles.

The oil level in the transmission is dependent upon the oil temperature. The maximum and minimum oil level marks on the dipstick are applicable references only if the transmission fluid has reached its normal operating temperature of 176° F (80° C). – If, however, the transmission fluid cools down to 68–86° F (20–30° C), which is the normal shop temperature range, then the maximum oil level will be approximately 1.18 in (30 mm) below the minimum mark on the dipstick. We stress this point because an oil change is normally performed when the transmission oil has cooled down to shop-temperature.

The fluid level must not exceed the dipstick maximum mark. Drain or siphon off excess fluid, if required.

Electrical System

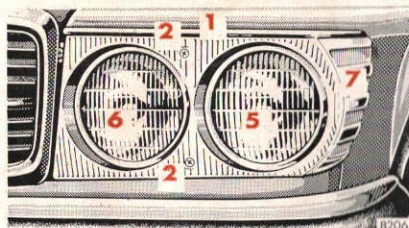

Replacing Bulbs

To remove, push the bulb in and turn to the left, then lift the bulb out.

To install, grip the bulb with a paper tissue or similar cloth, align the pins on the base of the bulb with the grooves in the bulb socket, push in lightly and turn to the right until the stop is felt.

Install only bulbs of prescribed wattage. Refer to "Technical Data".

Headlight Aiming

Correct headlight aiming is of paramount importance to the road-worthiness of the car. Check and readjust headlights at regular intervals and invariably when a lamp has been replaced.

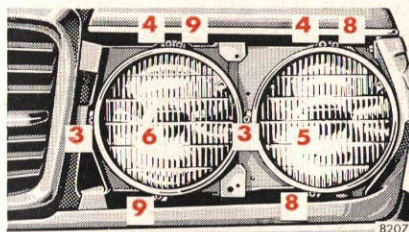

Front Lights

(Sealed Beam Version – USA Specifications)

- 1 Cover
 - 2 Securing screws for cover
 - 3 Horizontal aiming screws
 - 4 Vertical aiming screws
- Loosen securing screws 2 and detach cover 1.
- 5 High and low beam sealed-beam unit (type 2):
Loosen clamping screws 8, remove retaining ring and unit, disconnect plug and socket on unit.

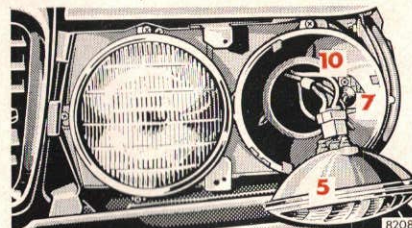

- 6 High beam sealed-beam unit (type 1):
Loosen clamping screws 9, remove retaining ring and unit, disconnect plug and socket on unit.
- 7 Side marker light:
Remove unit 5, loosen clamping screw 10 and detach lamp holder. Depress bulb, turn left and pull out.

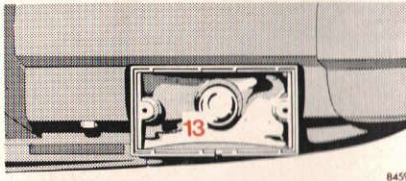
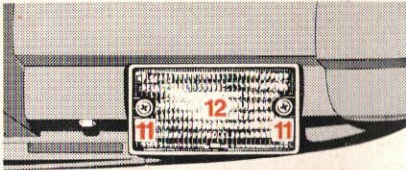

- 13 Bulb for turn signal, clearance and standing lights:

The lights are located below the bumper.

Loosen securing screws 11 and remove lens 12.

Depress bulb 13, turn left and pull out. When replacing the lens, it must be ensured that the lug in the lens is at the bottom.

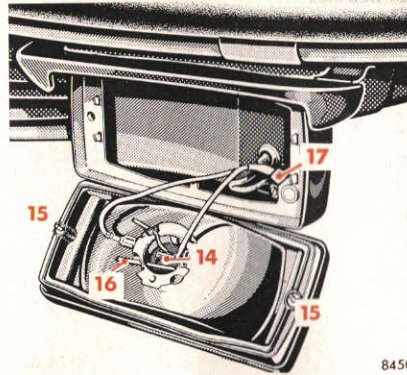

- 14 Bulb for fog light:
Loosen securing screws 15 and remove housing. Detach holding spring 16, remove bulb 14 and disconnect plug 17.

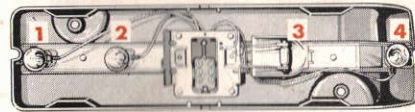
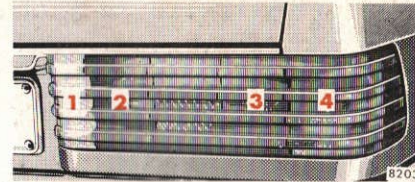

Tail Light Assembly

Loosen both the knurled nuts in the trunk and detach lamp bracket. To replace the bulbs, depress, turn left and pull out.

- 1 Backup light
- 2 Stop light
- 3 Standing light/tail light
- 4 Turn signal light (ball lamp) side marker light (festoon lamp)

Electrical System

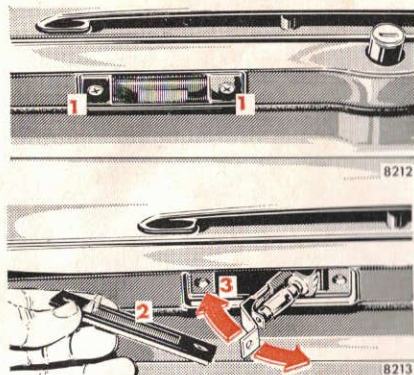

License Plate Light

Loosen both the securing screws (1) of the light, detach lens with gasket (2) and pull down lamp holder (3) on the L-H side. When replacing the lens, it must be assured that the lug in the lens is on the L-H side.

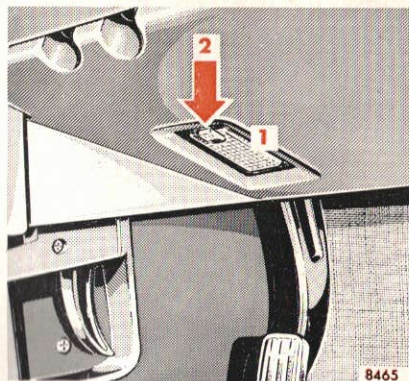

Footwell lights

Press off light (1) at the nose (2), replace bulb and press light on again.

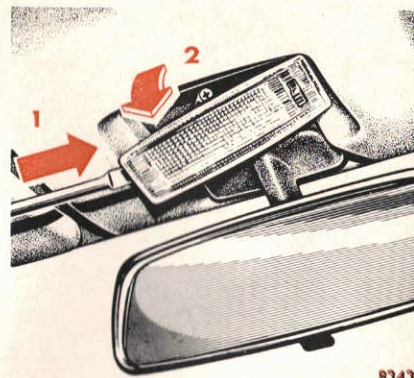

Dome Lights (450 SLC)

To replace the bulb, slightly press forward dome light to the right (1), lift up at left side (2) and then pull out to the left.

Remove rear dome light likewise.

Indicator Lights and Instrument Lighting

Be sure to select the correct wattage when replacing a bulb.

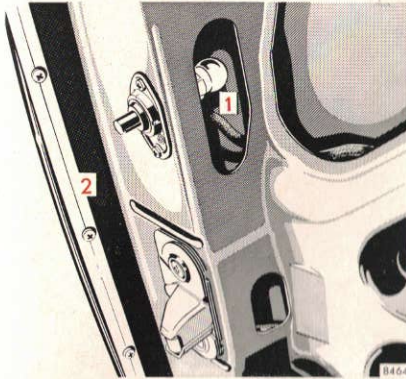

Trunk Light

The trunk light (1) is easily accessible when the trunk lid (2) is opened. To replace the bulb, depress, turn counterclockwise and take it out.

Spark Plugs

This vehicle is equipped with spark plugs as required for driving in the USA. Should additional information be necessary, your MERCEDES-BENZ dealer will be happy to offer advice.

For faultless engine operation, the spark plugs must not be fouled. To "clear" fitted plugs from time to time, operate the engine under load conditions and at a high RPM number in the lower gears – as on gradients – but avoid overrevving it.

A special wrench must be used for the removal and installation of spark plugs.

Battery

Check the battery electrolyte level about every 4 weeks, in summer and in tropical areas more often (depending on conditions).

The electrolyte level must reach the cell markings.

Replenish only with distilled water and do not use metal funnels.

Lubricate battery terminals with acidproof grease. Keep battery clean and dry.



**Technical Data
Fuels Coolants
Lubricants etc.**

Identification Plates Vehicle Data Cards

When ordering spare parts, please quote chassis and engine numbers.

The illustration depicts model 450 SL. On model 450 SLC identification plates are arranged accordingly.

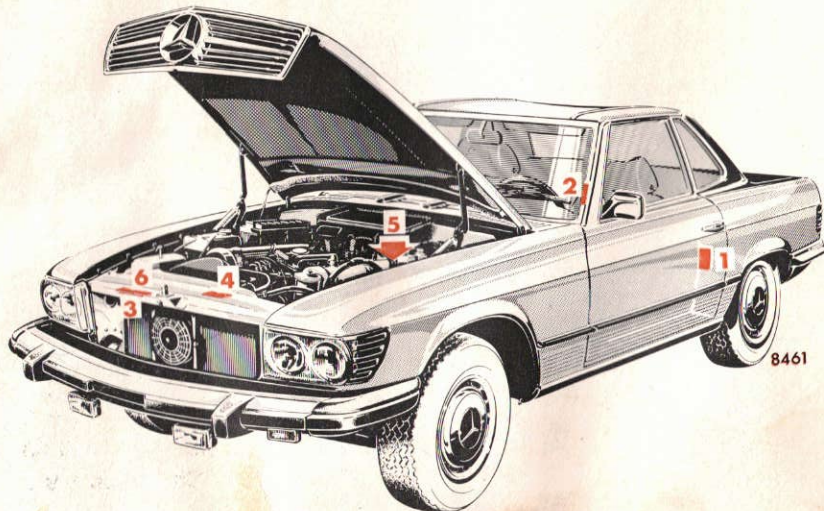

- | | |
|---|------------------------------------|
| 1 Certification Tag (left door pillar) | 4 Body No. and Paintwork No. |
| 2 Identification Tag (left window post) | 5 Engine No. on engine block, rear |
| 3 Chassis No. | 6 Emission control information |

With your MERCEDES-BENZ you receive two vehicle data cards listing all major vehicle data.

Card No. 1 lists the key number and should on no account be left in the car. Submit this card to your MERCEDES-BENZ service station to request a replacement key in case of loss.

8314

Card No. 2 on which the key number was made illegible is kept in the service booklet. If you present it to the service station, you facilitate the processing of the order.

8315

Chassis type 450 SL	107 044
Chassis type 450 SLC	107 024

Engine

Engine type	M 117
Mode of operation	4-stroke engine, electronic gasoline injection
No. of cylinders	8
Bore	3.62 ins. (92 mm)
Stroke	3.35 ins. (85 mm)
Total piston displacement ..	275.8 cu. ins. (4,520 cm ³)
Compression ratio	8
Output according to SAE: Federal	190 net bhp
California	180 net bhp
Max. perm. speed	5,800 rpm
Valve clearance (cold engine)	Intake 0.003 in. (0.08 mm) Exhaust 0.008 in. (0.20 mm)
Firing order	1-5-4-8-6-3-7-2

V-belts:

Water pump – fan – power steering pump	
2 V-belts	9.5×1,160 DA
Alternator	9.5×1,000 DA
Refrigerant compressor	12.5× 850 DA

Transmission

Design	Automatic transmission
--------------	------------------------

Steering

Design	Power steering
--------------	----------------

Electrical System

3-phase alternator	14 V/55 A
Starter motor	12 V/1.4 H.P.
Battery	12 V/66 Ah
Spark plugs	Beru D 175/14/3 A Bosch W 175 T 30 Champion N 3 Y

Technical Data

Bulbs	12 V
High and low beams .. Sealed beam insert No. 1 and 2	
Fog lights	H 3
Turn signal, clearance and standing lights, front	21/5 W (32/3 cp)
Side marker lights, front	4 W (2 cp)
Side marker lights, rear	5 W festoon lamp
Turn signal lights, rear	21 W (32 cp)
Tail and standing lights, rear ...	5 W festoon lamp
Stop lights	21 W (32 cp)
Backup lights	21 W (32 cp)
License plate lights	5 W festoon lamp
Footwell lights	5 W festoon lamp
Dome lights (450 SLC)	10 W festoon lamp
Trunk light	5 W (3 cp)

Main Dimensions

Overall vehicle length	
450 SL:	182.3 ins. (4,630 mm)
450 SLC:	196.4 ins. (4,990 mm)
Overall vehicle width	70.5 ins. (1,790 mm)

Overall height (ready for driving)

450 SL:	Roadster	51.2 ins. (1,300 mm)
	Coupé	50.8 ins. (1,290 mm)

450 SLC:	52.4 ins. (1,330 mm)
Wheel base 450 SL:	96.9 ins. (2,460 mm)
450 SLC:	111 ins. (2,820 mm)
Track, front	57.2 ins. (1,452 mm)
Track, rear	56.7 ins. (1,440 mm)

Wheels-Tires

Wheels	6½ J × 14 H 2
Radial tires	205/70 HR 14

Weights

See certification tag

Fuels Coolants Lubricants etc. Capacities

Vehicle components and their respective lubricants must match.

Therefore use only brands tested and recommended by us.

Enquire at your MERCEDES-BENZ service station.

	Capacity	Fuels, coolants, lubricants, etc.															
Crankcase	max. 15.9/13.2 US/Imp. pts. (7.5 l) min. 11.6/9.7 US/Imp. pts. (5.5 l)	<p>Recommended engine oil</p> <p>Ambient temp.¹</p> <table border="1"> <thead> <tr> <th>° F</th> <th>° C</th> <th>SAE grades</th> </tr> </thead> <tbody> <tr> <td>+50</td> <td>+10</td> <td>30¹ 20 W-40¹ 20 W-50¹</td> </tr> <tr> <td>+32</td> <td>0</td> <td>10 W-30¹</td> </tr> <tr> <td>+4</td> <td>-20</td> <td></td> </tr> <tr> <td>-13</td> <td>-25</td> <td>5 W-20</td> </tr> </tbody> </table> <p>10 W-40 10 W-50</p> <p>Year-round use multi-grade oil</p> <p>8337</p> <p>¹ SAE 40 may be used if ambient temperatures constantly exceed +86° F (+30° C). ² Use in temperate zones such as Central Europe as of April until October. ³ Use in temperate zones such as Central Europe as of October until April.</p>	° F	° C	SAE grades	+50	+10	30 ¹ 20 W-40 ¹ 20 W-50 ¹	+32	0	10 W-30 ¹	+4	-20		-13	-25	5 W-20
° F	° C	SAE grades															
+50	+10	30 ¹ 20 W-40 ¹ 20 W-50 ¹															
+32	0	10 W-30 ¹															
+4	-20																
-13	-25	5 W-20															
Oil filter	1.6/1.3 US/Imp. pts. (0.75 l)																
Automatic transmission	Initial fill: 18.8/15.7 US/Imp. pts. (8.9 l) Fluid change: 16.7/13.9 US/Imp. pts. (7.9 l)	Specifically tested and recommended automatic transmission fluid (ATF) according to Dexron															

Fuels Coolants Lubricants etc. Capacities

	Capacity	Fuels, coolants, lubricants, etc.
Rear axle	2.7/2.3 US/Imp. pts. (1.3 l)	Hypoid gear oil SAE 90. With limited slip rear axle special hypoid oil
Accelerator control system		Specially tested hydraulic fluid
Power steering	3.0/2.5 US/Imp. pts. (1.4 l)	Automatic transmission fluid (ATF), Dexron type
Front wheel hubs	2.3–2.8 oz. each (65–80 g each)	Antifriction bearing grease
Grease nipples		Lubrication grease
Door locks		Special grease
Battery terminals		Bosch special grease
Ignition distributor (breaker rubbing block)		Bosch special grease
Brake reservoir	1.1/0.9 US/Imp. pts. (0.5 l)	Brake fluid
Windshield washer system	approximately 3.2/2.6 US/Imp. pts. (1.5 l)	Water plus MB windshield detergent
Fuel tank	approximately 23.8/19.8 US/Imp. gals. (90 l)	Gasoline with a minimum RON of 91. Lead-free gasoline may also be used
	31.7/26.4 US/Imp. pts. (15.0 l)	Water with antifreeze and with 10 cu. cm of treating agents per liter

Engine Oils

Engine oils are specifically tested for their suitability in our engines. Therefore, use only engine oils recommended by us. Information on recommended brands is available at any MERCEDES-BENZ service station.

A new or reconditioned engine is filled with an initial operation oil

in the factory or in a MERCEDES-BENZ service station. This oil is specially developed for the specific operating conditions during the first 200–600 miles (300–1,000 km).

A recommended engine oil may be used for topping up if the oil level drops to the dipstick minimum mark prior to the first service (200–600 miles = 300–1,000 km).

Fuels

For ping-free engine operation gasoline with a minimum research octane rating (RON) of 91 must be used. Lead-free gasoline may also be used.

on.
and (A11), according

Fuels Coolants Lubricants etc.

Coolants

In the works the cooling water is blended with antifreeze (protection to about -22°F / -30°C) and treating agent.

In areas with moderate temperatures (e. g. in Central Europe) the cooling water / antifreeze mixture may remain in the cooling system all the year round. It should, however, be renewed after 2 years at the latest.

The cooling water / antifreeze mixture may be drained from vehicles driven in countries having extremely tropical climate and be replaced by water with treating agent.

We recommend this action in case of very hard conditions.

In case of a leak replenish

with water, antifreeze and treating agent. For normal replenishment (on account of water evaporization), plain water will do.

Treating agents

Scale, corrosion and cavitation diminish the efficiency of the cooling system and may even harm the cooling and heating system.

The addition of a treating agent prevents their formation.

To treat the cooling water, do not add any more than 1% (10 cu.cm/l) of a recommended treating agent.

Antifreeze

Prior to the onset of the cold season, check the cooling water / antifreeze mixture for its resistance to cold. Repeat several times as long as frost persists. Regular

checking of the antifreeze density is required only during each MERCEDES-BENZ maintenance service.

Information on recommended antifreezes and treating agents is available at each MERCEDES-BENZ service station.

Protection up to	Antifreeze
14°F (-10°C)	6.3/5.3 US/Imp. pts. (3.0 l)
-4°F (-20°C)	11.2/9.3 US/Imp. pts. (5.25 l)
-22°F (-30°C)	14.3/12.0 US/Imp. pts. (6.75 l)
-40°F (-40°C)	16.4/13.5 US/Imp. pts. (7.75 l)

Printed in Germany

We reserve the right to modify given in the data and illustrations. No part of this manual may be reproduced without the written authorization in writing.

ZKD VIII. 73. 8. Ru.

Service-Literature

Customers who are interested in obtaining service literature for their vehicles are advised to contact our subsidiaries in the U.S. or Canada at the following addresses, respectively

for U.S.A.: Mercedes-Benz of N.A. Inc.
One Mercedes Drive
P. O. Box 350
Montvale, New Jersey 07645
Att: Technical Literature
Tel: (201) 573-0600

for Canada: Mercedes-Benz of Canada
849 Eglinton Ave., East
Toronto 17, Ont., Canada
Att: Service Department
Tel: 416-425-3550

The above companies will be happy to handle requests from customers.

We consider this to be the best way in obtaining information for your vehicle.

with
recommend this
on in c
ery ha
ones.
a lea
pleni

Printed in Germany

We reserve the right to modify
given in the data and illustrations.
No part of this manual may be
reproduced or translated without prior
authorization in writing.

ZKD VIII. 73. 8. Ru.

the technical details of the vehicle as
shown in this Owner's Manual (s.e.e.o.).
reproduced or translated without prior

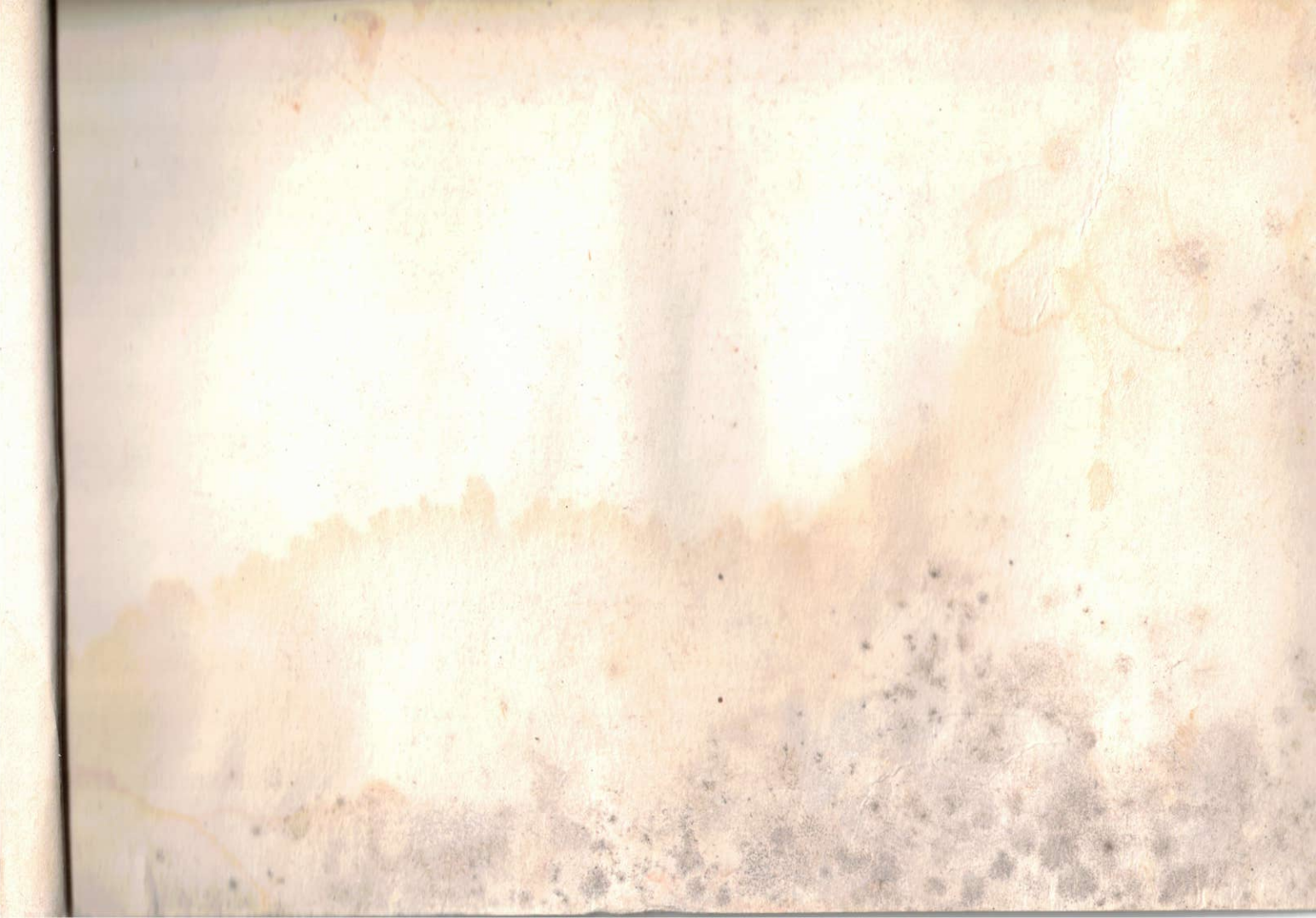

107 584 38 96

6500 4783

450 SL · 450 SLC · USA-Ausgabe B

Daimler-Benz AG Stuttgart-Untertuerkheim

Zentralkundendienst