

Owner's  
Manual

450 SL  
450 SLC

Mercedes-Benz



1980

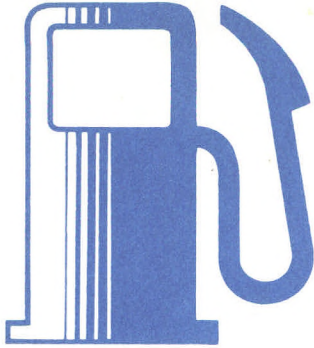

16

## Drive Sensibly – Save Fuel

Fuel consumption depends to a great extent on driving habits and operating conditions.

In order to save fuel you should:

- ensure that tire pressures are correct
- not carry unnecessary loads
- remove ski racks or roof-mounted luggage racks when not in use
- not warm up your engine at idle and with the vehicle at standstill
- avoid frequent acceleration and deceleration
- avoid frequent braking
- avoid unnecessarily high speeds
- have all the maintenance jobs specified by us carried out at regular intervals by a MERCEDES-BENZ service station.

Driving in low temperature weather, in stop-and-go city traffic and on short hops, and in hilly country also increases fuel consumption.

Owner's  
Manual

450 SL  
450 SLC

Mercedes-Benz



Type 107  
1980





You have chosen to drive a MERCEDES-BENZ, a car in whose construction and production we have taken great pains because we believe that quality is not a matter of chance.

Perhaps you have already had experience with a MERCEDES, maybe this is your first car from the DAIMLER-BENZ company. In both cases – for your own benefit – please read this owner's manual before putting it away. Even though you have been driving a car for years, some things in this car may be new to you, and this manual certainly contains a few hints which will help you to make the most of your new car.

We wish you safe and pleasant motoring.  
DAIMLER-BENZ Aktiengesellschaft

## Contents

---

*This Owner's Manual also describes optional extras as far as an introduction on their handling is required. As these extras need to be ordered separately, the equipment of your vehicle may deviate from the descriptions and illustrations to some extent.*

### The last page

What you should know at the gas station

### Vehicle Operation

Instruments and Controls	8
Instrument Cluster	10
Keys, Doors	12
Flat Key, Master Key and Supplementary Key	12
Obtaining Replacement Keys	12
Opening, Locking and Unlocking of Doors	12
Master Lock System	13
Seats	14
Adjustment of Driver's Seat and Front Passenger Seat	14
Safety Belts	15
Safety Headrest	16
Controls	17
Steering Lock	17
Lighting Switch	17
Combination Switch	18
Cruise Control	19
Automatic Climate Control	20
Various Equipment	23
Interior Lamps	23
Rear View Mirrors	23
Sun Visor	23
Lighter	24
Heated Rear Window	24
Shelf below Rear Window	24
Electric Window Lifters	25
Roadster Top	26
Hardtop	27

Sliding Roof	28
Radio	29

### Driving

Hood	34
Parking Brake	34
Regular Inspections	35
Catalytic Converter Cautions	36
Starting and Turning off the Engine	37
Starting and Shifting Gears	38
Safe Driving	40
Brake Pad Wear Indicator Lamp	41
Brake Fluid	41
Charge Indicator Lamp	41
Oil Pressure Gauge	42
Coolant Temperature Gauge	42
Emission Control	42
Engine Oil Consumption	42
The First 1500 km/1000 Miles	43
Special Operating Conditions	43
Winter Driving	43
Hints for Driving	44
Tire Chains	44
Traveling Abroad	44

**Vehicle Care**

MERCEDES-BENZ Maintenance System ..... 46  
 Severe Operating Conditions . 46  
 Engine Oil Change and Filter Change ..... 47  
 Automatic Transmission-Fluid and Filter Change ..... 47  
 Spare Parts Service ..... 47  
 Cleaning and Care of the Vehicle 48  
 Jobs related to Care ..... 49

**Practical Hints**

Ash trays ..... 52  
 Rear Seat Cushion ..... 52  
 First Aid Kit ..... 53  
 Luggage or Ski Racks ..... 53  
 Spare Wheel, Jack, Vehicle Tool Kit ..... 53  
 Wheels, Tires, Changing Wheels ..... 54  
 Wheels and Tires ..... 54  
 Changing Wheels ..... 55  
 Tire Inflation Pressure ..... 56  
 Checking Fuels, Coolants, Lubricants, etc. .... 57  
 Engine Oil Level Check ..... 57  
 Replenishing Coolant ..... 57  
 Automatic Transmission Fluid Level ..... 58

Electrical System ..... 59  
 Fuses ..... 59  
 Battery ..... 59  
 Spark Plugs ..... 59  
 Replacing Bulbs ..... 60  
 Sliding Roof-Emergency Operation ..... 64  
 Unlocking of the Filler Flap .... 64  
 Emergency-starting and Towing the Vehicle ..... 65  
 Jump Starting ..... 66

**Technical Data – Fuels, Coolants, Lubricants, etc.**

Identification Plates ..... 68  
 Vehicle Data Cards ..... 69  
 Technical Data ..... 70  
 Fuels, Coolants, Lubricants, etc. 72  
 Capacities ..... 72  
 Engine Oils ..... 74  
 Brake Fluid ..... 74  
 Coolants ..... 75  
 Service Literature ..... 76

**Vehicle Operation**



**Driving**



**Vehicle Care**



**Practical Hints**



**Technical Data – Fuels, Coolants, Lubricants, etc.**





# Vehicle Operation





## Instruments and Controls

---

*For more detailed descriptions see quoted pages.*

- 1** Swivelling side ventilation outlets (page 20)
- 2** Control lever for side ventilation (page 20)
- 3** Parking brake release button (page 34)
- 4** Hood release lever (page 34)
- 5** Parking brake pedal (page 34)
- 6** Combination switch (page 18)
- 7** Lighting switch (page 17)
- 8** Instruction tag (except tourist vehicle).  
Use only unleaded gasoline
- 9** Cruise control (page 19)
- 10** Instrument cluster (page 10)
- 11** Horn control
- 12** Steering lock with ignition/starter  
switch (page 17)
- 13** Swivelling outlets for cooled air (page 20)
- 14** 450 SL: Switch for front dome lamps  
450 SLC: Switch for rear dome lamp
- 15** Switch for automatic antenna (page 31)
- 16** Switch for heated rear window (page 24)
- 17** 450 SLC: Switch for electric sliding roof  
(page 28)
- 18** Radio (page 29)
- 19** Automatic climate control (page 20)
- 20** Ash tray with lighter (page 24, 52)
- 21** 450 SLC: Loudspeaker – fader  
control (page 30)
- 22** Switch group for window lifters (page 25)
- 23** Hazard warning flasher switch  
Push switch = hazard warning flasher system  
switched on  
Push switch once more = hazard warning  
flasher system switched off
- 24** Glove compartment (to open, shift handle  
sideways). Only illuminated if steering lock is  
in position “1” or “2”.
- 25** Loudspeaker cover, right and left

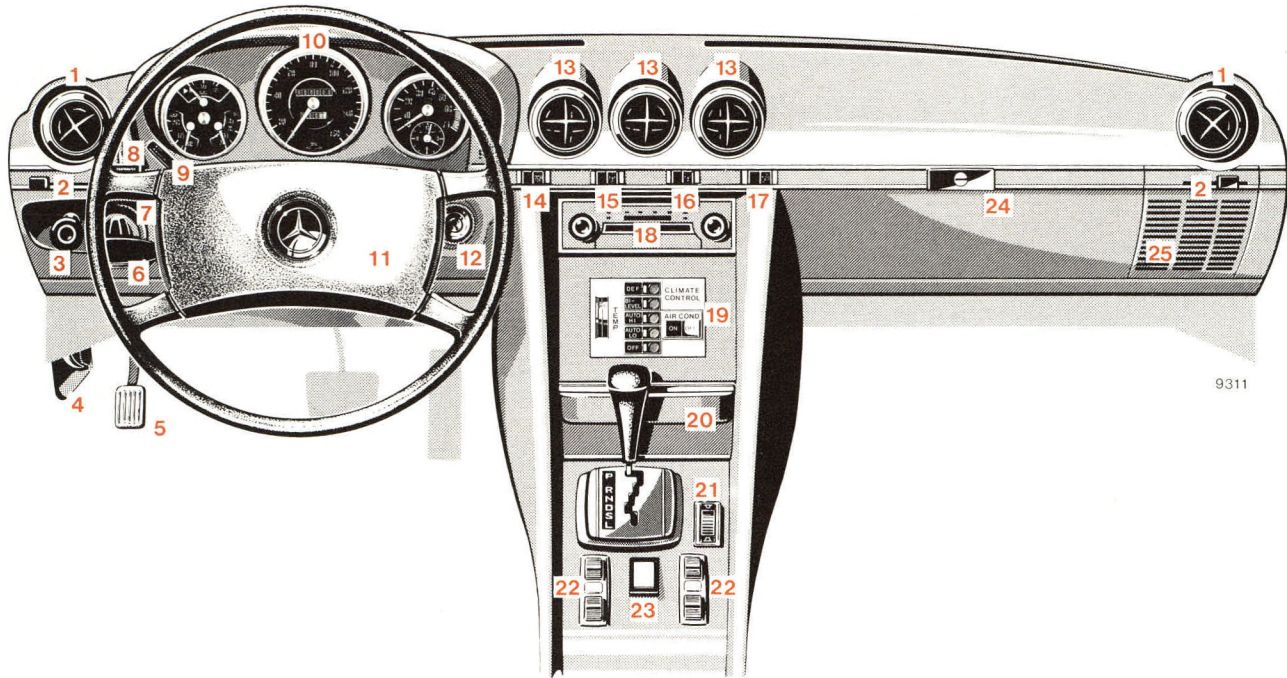

9311

## Instrument Cluster

---

- 1 Coolant temperature gauge ( $^{\circ}$  C)  
Up to red marking: Maximum permissible temperature for an antifreeze-blended fill protecting down to  $-30^{\circ}$  C/ $-22^{\circ}$  F
- 2 Fuel gauge with reserve warning lamp (yellow)  
Fuel reserve for approximately 35–40 km/22–25 miles  
For capacity, refer to page 73 and last page
- 3 Oil pressure gauge (bar)
- 4 Main odometer
- 5 Trip odometer
- 6 Knob for clock adjustment (press in for adjustments)
- 7 Electric clock
- 8 Tachometer
- 9 Red marking on tachometer:  
Excessive engine revolutions
- 10 Turn signal indicator lamp, right (green)
- 11 O<sub>2</sub>-Sensor replacement indicator lamp (red):  
When the indicator lamp comes on, the O<sub>2</sub>-Sensor must be replaced
- 12 Seat belt warning lamp (red)
- 13 Brake pad wear indicator lamp (red):  
Lamp comes on while braking and driving if the front wheel brake pads are worn down, refer to page 41
- 14 Dimmer knob for instrument lamps, continuous adjustment
- 15 Resetting knob for trip odometer (push button)
- 16 Brake warning lamp (red) comes on if
  - the parking brake is engaged
  - too little brake fluid is in the reservoir
- 17 High beam indicator lamp (blue)
- 18 Charge indicator lamp (red):  
Comes on when the steering lock key is moved to driving position “2” and must go out when the engine is idling
- 19 Turn signal indicator lamp, left (green)

### Note

A stop is provided on the speedometer at the 138 km/h/85 mph reading. Speeds in excess of 138 km/h/85 mph will no longer be recorded.



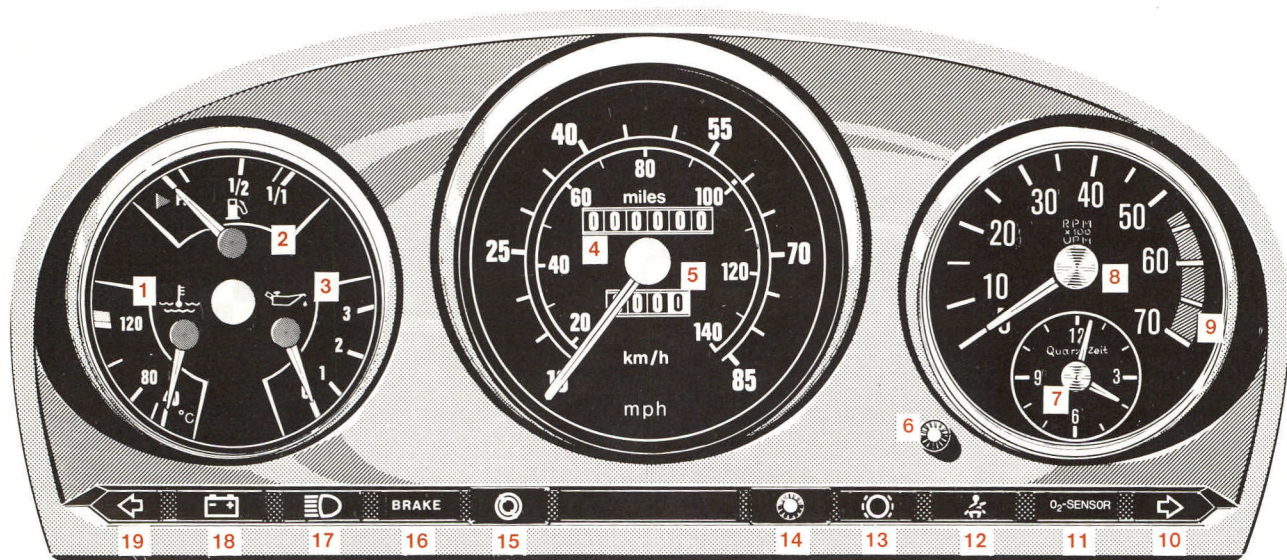

9224

## Keys Doors

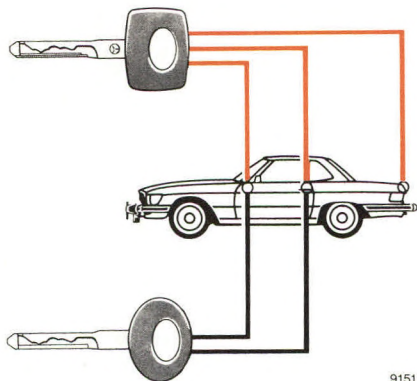

9151



### Flat Key

The flat key fits all vehicle locks. We recommend that you carry the flat key with you and keep it in a safe place so that it is always handy, if needed (e.g. in your wallet). Never leave the flat key in the vehicle.

**Master Key** – square headed – fits all locks on the car.

**Supplementary Key** – rounded head – fits only the door locks and the steering lock. This key is intended to be used whenever the car is left

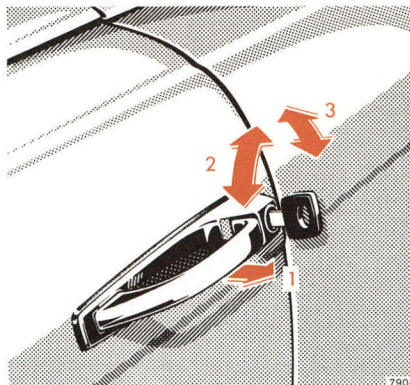

7904

with an attendant. Be sure to lock glove compartment and trunk with the master key.

### Obtaining Replacement Keys

Replacement keys can be obtained only via MERCEDES-BENZ service stations. If the keys are lost, assistance is rather time consuming and expensive.

### Opening the Doors

From outside: pull handle outwards (1).

From inside: pull handle in door panel (4).

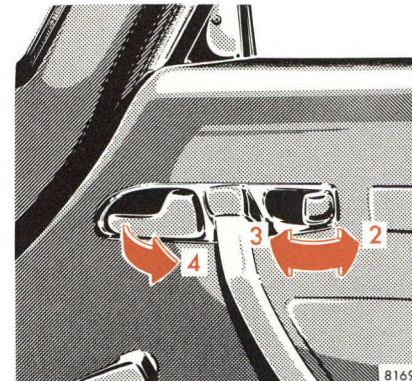

8169

### Locking and Unlocking of Doors

From the outside: turn key.  
From the inside: actuate safety catch.

- 2 Unlocking
- 3 Locking

One cannot lock:

- the driver's door if it is open.
- any door if the door lock has not engaged fully. In this case open the door and shut it again.



### Master Lock System

The master lock system enables the front passenger door, the fuel tank filler flap and the trunk lid to be locked or unlocked together with the driver's door. When locking or unlocking, the locking levers on both doors must move simultaneously. If one locking lever fails to do so, the lock of that particular door is not properly engaged. The door must then be opened and closed correctly.

With the master lock system in the locked position, the front passenger door can be locked and unlocked either with the locking lever or with the key.

Actuation of the locking lever on the front passenger door, however, is not possible when the master lock system is in the unlocked position.

The trunk lid can also be unlocked separately by turning master key counterclockwise to the stop. Push

the trunk lock button in with it and lift the lid. Return the key to its initial position and withdraw it. To lock the lid, close it firmly. It will then be locked again by the master lock system.

A provision has been made to facilitate permanent locking of the trunk lid for positive prevention of access to trunk by unauthorized persons.

Before leaving vehicle with an attendant, lock trunk with master key (square head) by turning key clockwise to stop (tumbler slot vertical), then provide attendant with round-headed supplementary key. Thus, the trunk lock has been excluded from the operation of the master lock system and cannot be opened except with the square-headed master key.

To reverse this, turn trunk lock counterclockwise back to horizontal position of the tumbler slot with master key. Lock will then be reengaged in master lock system; that is, it will automatically be locked or unlocked depending on whether the driver's door is locked or unlocked.

The master lock system operates on vacuum generated by the engine. A reservoir allows the master lock system to be actuated about five times after the engine is turned off. If the system can then no longer be engaged, idle engine for a short period.

If no vacuum is available, doors and trunk have to be locked individually in the normal manner. The fuel tank filler flap, however, remains unlocked.

Note:

If the filler flap cannot be opened when the master lock system is unlocked, refer to "Unlocking of the Filler Flap" (page 64).

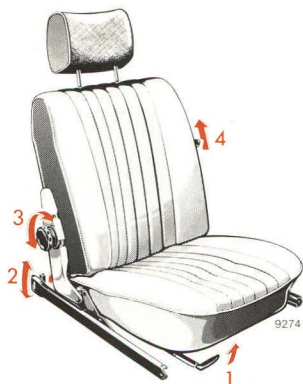

### Adjustment of Driver's Seat and Front Passenger Seat

Forward/backward adjustment: lift handle (1), push seat backward or forward and allow handle to reengage.

Height adjustment of driver's seat (3 positions): pull out rotary handles (2) at the rear ends of the guide rails, turn to desired position and allow to reengage.

The height of the front passenger seat can be adjusted, if necessary, by relocating the guide rails (2 positions). To do so, unscrew both the rear clamping screws and screw in again at the respective bore.



Back rest tilt: turn handwheel (3) back or forth.

For full reclining of backrest, seat should be moved to one of the forwardmost positions and headrest removed. For driving, return backrest to upright position and push seat back. Replace headrest.

450 SL: After disengaging the stop by lifting knob (4), the back rest can be folded forwards.

450 SLC: Backrests are vacuum-locked when the doors are closed. One can unlock them from the rear seat by means of a button (5)

accommodated in the respective lateral panelling of the rear passenger compartment. With opened doors the backrests will fold forward without pressing the buttons.

#### Note:

Prior to operating the vehicle, the driver should adjust the seat height for proper vision as well as fore-aft placement and seat back angle to insure adequate control, reach, operation, and comfort. The headrest should also be adjusted for proper height so that when the cushion is tipped completely forward, it should form a cradle behind the seat occupant's head. Both the inside and outside rear view mirrors should then be adjusted for adequate rearward vision. Fasten seat belts. Children under the age of six or under the weight of 23 kg/50 lb should be seated in the back seat with an approved restraint system properly secured.

All seat, headrest, and rear view mirror adjustments as well as fastening of seat belts should be accomplished before the vehicle is put into motion.



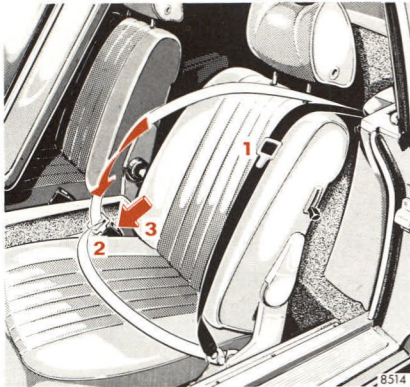

450 SL

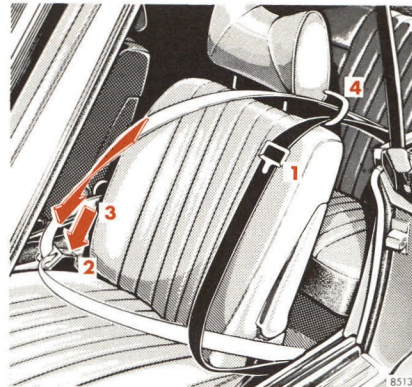

450 SLC

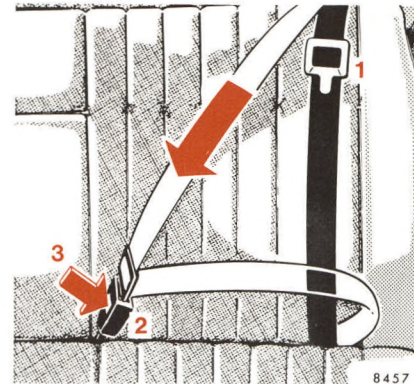

450 SLC

## Safety Belts

### Warning System:

The indicator is illuminated for 4-8 seconds after turning the steering lock key to position "2". If the safety belt of the driver's seat is not fastened a warning buzzer sounds simultaneously.

Fastening of front and rear seat belts (with inertia reel):

- Pull belt with tongue (1) across shoulder and lap. The belt must not be twisted and must be tight.
- Press tongue (1) into buckle (2) and allow to engage audibly.

Unfastening, front and rear:

- Depress red button (3) in buckle (2).
- Return tongue (1) to initial position.

450 SLC: On entering or leaving the rear passenger compartment, the safety belt must be disengaged from guide (4).

## Seats

**Operation of belts with inertia reel:**  
The safety belt inertia reel stops the belt from unwinding further in case of vehicle deceleration in any direction or if the belt is pulled out quickly.

**Functional test:**

The locking function of the inertia reel can be tested by braking, driving around a bend or by pulling the belt out quickly.

**Note:**

No safety belt can be used for more than one person. Belts are not intended for children.

After an accident, inspect the safety belts and replace them, if required. The belt anchors in the vehicle should also be checked.

Renew damaged belt webbing.

Belt webbing must not be routed via sharp edges.

No modifications which may affect the efficiency of the belts must be made.

For cleaning and care of belt webbing, refer to page 49.

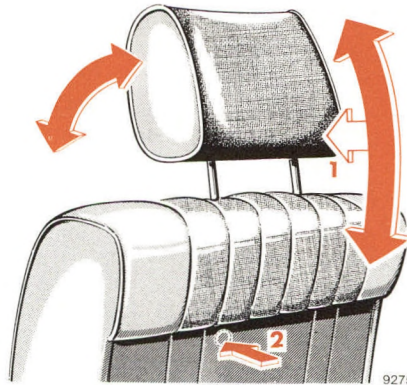

### Safety Headrest

Adjust headrest to support the back of the head at the level of the upper end of the ear.

Height adjustment:

Press headrest slightly forward (1) and reset upward or downward.

### Detaching headrests:

Pull headrest out to the stop. Release arrester by depressing locking knob to be felt under the backrest covering material and pull up headrest, holding it by the LH headrest post (viewed in driving direction). Finally pull out headrest completely with both hands.

The headrest locking knob of the front seat is located below the LH headrest post (2).



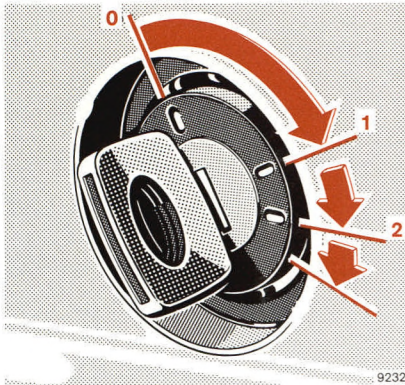

9232

### Steering Lock

- 0 Steering is locked when the key is withdrawn and the steering lock is engaged. The key can be withdrawn only in zero position.

**Note:**

Do not remove key from steering lock while the vehicle is in motion as this will cause the engagement of the steering lock thus rendering the vehicle inoperable.

Steering is unlocked.  
(If necessary, move steering wheel slightly to turn the key clockwise to position "1".)

### 2 Driving position

**Starting:**

Continue turning key clockwise to the stop. The starter is engaged when the key is pressed against the stop. The starter nonrepeat unit requires the key to be returned to position "0" prior to a new starting attempt.

**Notes:**

The following items can be operated with the key in steering lock position "1".

Wiper, windshield washer, headlamp flasher, lighter, glove compartment lamp, radio, electric seat heater for front seats.

The power supply to the standing lamps is disrupted if the key in the steering lock is in position "2".

A warning buzzer sounds when the key has been left in steering lock positions "1" or "0" and the driver's door is opened.

### Lighting Switch

- 0 Off-position
- 1 Parking lamps (includes side marker lamps, tail lamps, license plate lamps, instrument panel lamps)



B

A

8154

- 2 Same as pos. 1 plus headlamps
- 3 Standing lamps, right
- 4 Standing lamps, left
- A Turn to position 2 and pull out to first detent = same as position 2 plus fog lamps
- B Available for an option

**Note:**

With the steering lock key removed and the driver's door or the front passenger's door open a signal sounds if the vehicle's exterior lamps are not switched off (standing lamps excepted).



## Controls

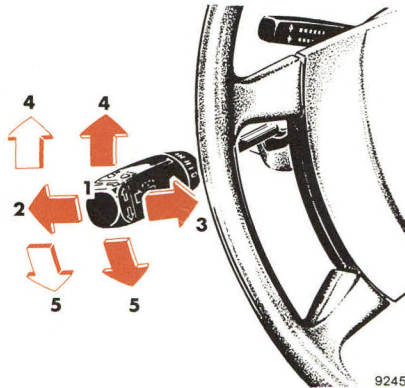

### Combination Switch

- 1 Low beam (lighting switch turned clockwise to 2nd notch)
- 2 High beam (lighting switch turned clockwise to 2nd notch)
- 3 Headlamp flasher (high beam available independent of lighting switch position)
- 4 Turn signals, right
- 5 Turn signals, left

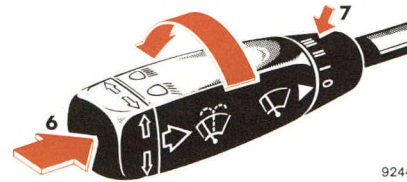

- 6 Control for windshield washer system

When the washer system is switched on, the wipers also operate

- 7 Windshield wiper control
  - 0 Windshield wiper switched off
  - I Intermittent wiping
  - II Normal wiper speed
  - III High wiper speed

### Hints:

If one of the turn signals fails, the turn signal indicator system flashes and sounds at a faster sequence than under normal operating conditions.

Fog lamps will only operate together with low beam headlamps. Fog lamps are turned off automatically when lighting switch is returned to off-position.

To operate the turn signals, move the combination switch past the point of resistance (up or down). The switch is automatically cancelled when the steering wheel is turned by a large enough angle.

To signal minor directional changes of the vehicle, such as changing lanes on a highway, move combination switch to the point of resistance only and hold it there.

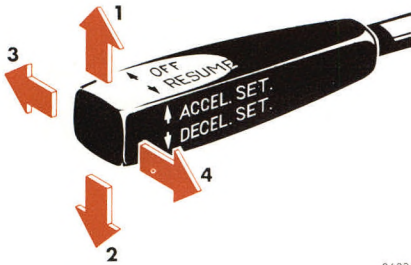

8623

### Cruise Control

Any given speed above a range of approximately 16–40 km/h/ 10–25 mph, depending on model, can be maintained with the cruise control by operating the switch.

- 1=Setting (touch switch)  
Accelerating (hold switch)
- 2=Setting (touch switch)  
Decelerating (hold switch)

Normally the vehicle is accelerated to the desired speed with the accelerator. Speed is set by briefly pushing the switch to position “1” or “2”, and the accelerator can be released. The speed can be increased (e. g. for passing) by using the accelerator. As soon as the accelerator is released, the previously set speed will be resumed automatically.

If the set speed is to be increased or decreased slightly (e. g. for adaptation to the flow of traffic), hold switch in position “1” or “2” until the desired speed is reached. When the switch is released, the newly set speed remains constant.

### 3= Cancelling

To cancel the cruise control, briefly push lever to position “3”.

The cruise control will also be cancelled if the brake pedal is actuated or if the vehicle speed drops on steep grades by more than 20 % below the set speed.

### 4= Resume

If the lever is briefly pushed to position “4” when driving at a speed exceeding approximately 16–40 km/h/10–25 mph, depending on model, that speed is resumed which was set prior to the cancellation of the cruise control.

The last memorized speed is cancelled when the key in the steering lock is turned to position “1” or “0”.

### Important:

Please do not use the cruise control if traffic conditions do not make it advisable to maintain a steady speed, i. e. in heavy traffic or on twisting or slick and muddy roads.

Position “Resume” should be engaged only if the driver is fully aware of the previously set speed and wishes to resume this particular preset speed.

When driving with the cruise control, the selector lever must not be shifted to position “N” as otherwise the engine will overrev.

## Automatic Climate Control

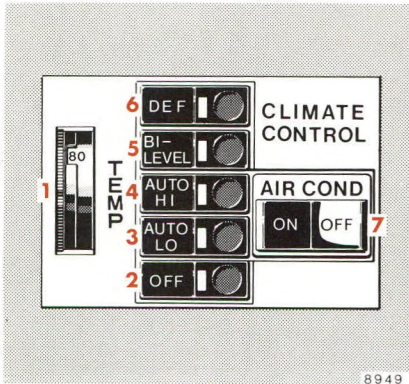

- 1 Temperature selector wheel
- 2 "OFF" button
- 3 "AUTO-LO" button
- 4 "AUTO-HI" button
- 5 "BI-LEVEL" button

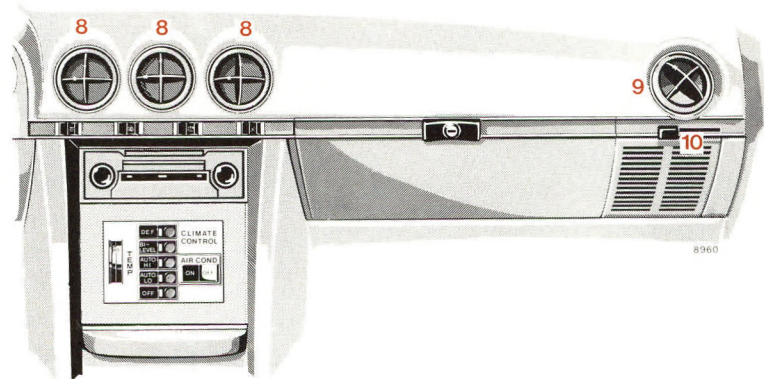

- 6 "DEF" button
- 7 Refrigerant compressor switch
- 8 Swivelling outlets for cooled air
- 9 Swivelling outlets for side ventilation
- 10 Lever for side ventilation  
open = towards center of vehicle  
closed = towards outside of vehicle



The automatic climate control is designed to maintain the desired temperature in the vehicle interior. Heating, cooling and air distribution (top, center, bottom) are controlled automatically. The blower speeds will be varied automatically depending on the push button setting, operating and temperature conditions.

The automatic climate control is operational only if the engine is running.

For adaptation to the weather conditions various functions can be selected with the pushbuttons. Air outlets 8 – 9 must then be adjusted as required. Buttons 2 – 6 can be pressed only individually. The indicator lamps in the individual buttons come on if the buttons are pressed and the vehicle lamps are switched on.

### 1 Temperature selector wheel

The desired temperature in the vehicle interior can be set with the selector wheel.

Normally only one adjustment is necessary for the entire year. If required to be altered, only slight adjustments should be made to this temperature setting.

### 2 “OFF” button: Switching off the automatic climate control.

Simultaneously the fresh air supply to the vehicle interior is cut off. This position can be briefly selected in the case of odorous or dust annoyances or when passing through an automatic car wash.

### 3 “AUTO-LO” button: Normal vehicle operation.

This setting will provide heating or cooling of the vehicle's interior depending on the selector wheel setting and the outside temperature. If heating is required, the fresh air supply and the blower will remain in the off position until the engine cooling water is slightly warmed up.

Only then will warm air enter the interior of the vehicle and be distributed mainly to the footwell outlets. A small amount of air is directed to the windshield to ensure defogging under normal weather conditions. For the defogging of the side windows, air can be diverted from the side outlets 9 depending on the position of levers 10. The center outlets 8 remain closed during heating operation.

If cooling of the interior is required, the blower will start immediately regardless of engine temperature. The air is routed via center outlets 8 into the vehicle's interior and additionally via the side outlets 9 depending on the position of lever 10. No air is allowed to flow to the windshield and to the footwell. The blower speed will be automatically reduced in several steps in the heating or cooling cycle as the interior temperature approaches the preselected temperature on the temperature wheel 1.

## Automatic Climate Control

- 4 “AUTO-HI” button:  
Fast heating or cooling of vehicle interior.  
Air conditioning, air distribution and blower control are the same as in position “3” “AUTO-LO”. The blower, however, operates at a higher speed.

- 5 “BI-LEVEL” button:  
For fogged-up windows. During heating and cooling operations air is channelled to the windshield and to the footwell. During the cooling operation air also enters via the center swivelling outlets 8. The vehicle interior is cooled practically free of draft with more air being blown into the footwell. The blower then operates at a higher speed than “AUTO-LO”.

We recommend this position at low ambient temperatures.

- 6 “DEF” button:  
For iced-up windows.  
Independent of the position of the temperature selector wheel air heated to maximum temperature is channelled to the windshield.  
For the side windows, open swivelling outlets 9.

- 7 Refrigerant compressor switch:  
Switching the air conditioning compressor on and off.  
The compressor can be switched off completely in the positions “AUTO-LO” and “AUTO-HI”, e. g. if no cooling is required because of low ambient temperatures (fuel economy).

Fresh air is supplied to the footwell if the refrigerant compressor is switched off while the system is working in the cooling mode.

Fresh air enters the vehicle through openings in front of the windshield (keep free of snow).

450 SLC and 450 SL with hardtop:  
When the windows are closed the air is emitted through ventilation opening below the rear window. Do not cover up ventilation openings with clothes etc.

### Important!

In order to keep the air conditioning section of the climate control system in good working condition at all times, it is necessary to operate the A/C compressor briefly at least once a month even during the seasons it is normally not required. Switch compressor switch to “ON” and depress “AUTO-LO” or “AUTO-HI” button. Make sure that the ambient temperature is above 2° C/36° F since the A/C compressor will not operate below this temperature.



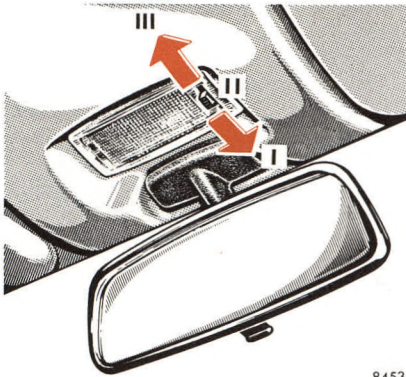

8453

### Interior Lamps

The footwell lamps below the instrument panel are switched on as long as one of the doors is open.

450 SL: The front dome lamps are switched on and off by means of a rocker switch on the instrument panel.

450 SLC: The switch for the front lamp has 3 positions.

Position I: lamp is switched on and off by the door contact switches.

Position II: lamp is continuously switched off.

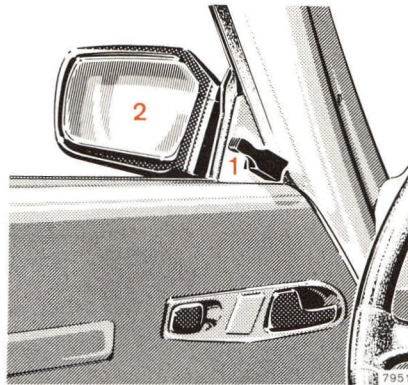

7951

Position III: lamp is continuously switched on.

The rear dome lamp is switched on and off by means of the toggle switch on the instrument panel.

### Rear View Mirrors

Outside rear view mirror:

Outside rear view mirror (2) can be randomly adjusted by means of lever (1).

Inside rear view mirror:

Mirror housing can be randomly adjusted. In addition mirror

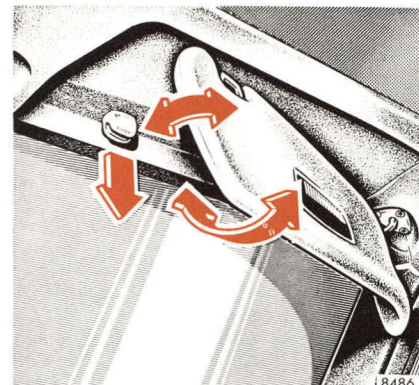

8486

can be dimmed by means of lever on lower mirror edge. Lever in opposite driving direction = normal position. Lever in driving direction = antidazzle position.

### Sun Visor

Swing sun visor down to protect against sun dazzle. If sunlight enters through the side windows, disengage visor from inner mounting and swing to the side.



## Various Equipment

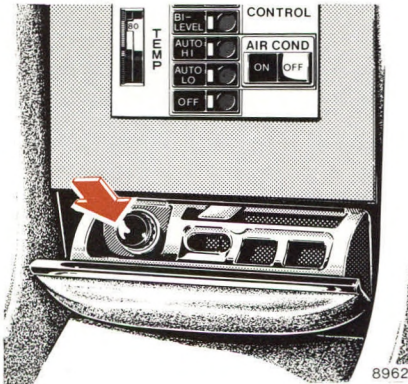

### Lighter

Turn key in steering lock to position "1" or "2".

Push the lighter in to heat it. It will pop out as soon as the filament glows.

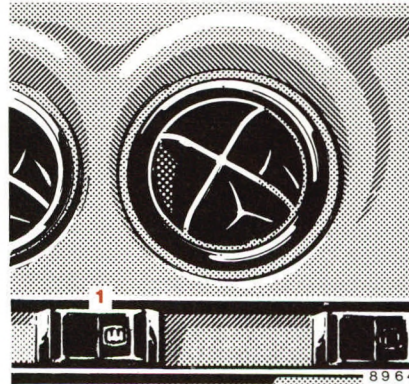

### Heated Rear Window

Turn key in steering lock to position "2".

When the rear window heater is turned on, the white indicator lamp in the switch (1) comes on.

A heavy load is imposed on the battery due to the high power requirement. For this reason, switch off the heated rear window as soon as it is demisted or defrosted. It is shut off automatically after a maximum of 30 minutes. Always remove heavy layers of ice and snow first.

### Shelf below Rear Window

Do not carry heavy or hard objects on the shelf below the rear window. Such items could become dislodged during hard braking or upon a vehicle crash causing distraction or serious injury to the vehicle occupants.

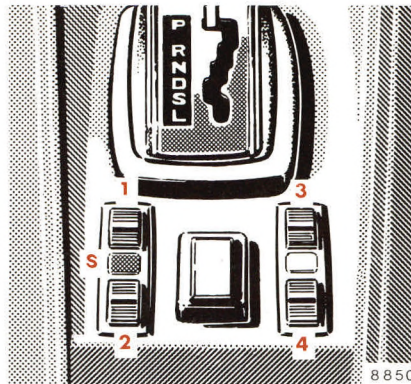

**Electric Window Lifters (450 SLC)**

Switch group for window lifters:

- 1 front, left
- 2 rear, left
- 3 front, right
- 4 rear, right
- S Safety switch

The electric window lifters can only be operated with the steering lock in position "2". All four windows can then be operated using the switches in the center console. The rear side windows can also be operated using the switches (5) in each rear side panel as long as the safety switch "S" in the center

console is depressed. If the safety switch is not depressed, inadvertent operation of the rear side windows (for instance, by children) is prevented.

When the ignition switch is turned off, the windows cannot be operated.



## Roadster Top

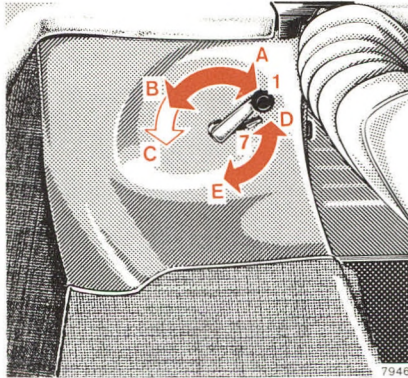

If possible, park vehicle in the shade as continuous exposure to sun rays will harm canvas color and rubber coating.

To lower or raise the folding top or to remove or attach the hardtop, find two locking handles in a bag stowed in the glove compartment. They are used to engage or disengage locks (4). Put locking handles back into the glove compartment after use.

Lowering the roadster top:

A wet or frozen canvas top must not be folded.

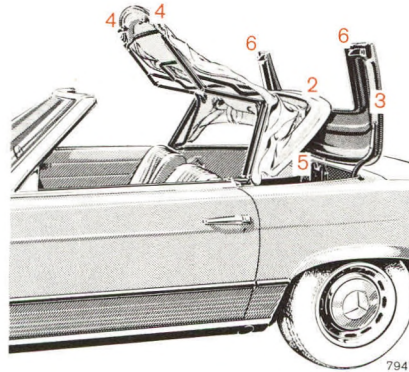

1. Unlock top bow (2) and top storage compartment cover (3) by shifting lever (1) to position C. Lever will automatically return to position B (bow remains unlocked but the top storage compartment cover can be locked). If the top bow cannot be raised in this position, shift lever (7) to position E.
2. Lift up top bow.
3. Open top storage compartment cover (3).

4. Disengage top framework by turning locks (4) inwards. Then detach locking handles.
5. Swing back top framework and slip top into top storage compartment (5). Stow overhanging canvas in the storage compartment.
6. Close top storage compartment cover, making sure that both sides (6) are locked.

Raising the roadster top:

1. Move lever (1) to position C and open top storage compartment cover (3).
2. Pull top out of storage compartment and rest top framework against windshield header bar.
3. Tighten top framework by turning locks (4) outwards.
4. Close top storage compartment cover, making sure that both sides (6) are locked.
5. Move downwards top bow until it locks and tighten with lever (1) (position A).



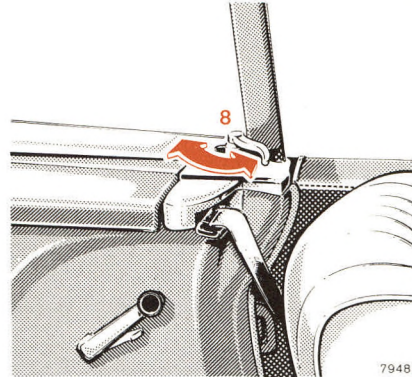
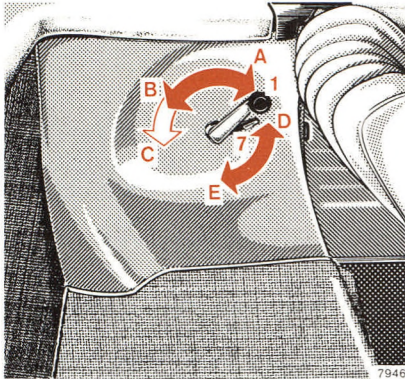

Removal or attachment of the hardtop is best done in a MERCEDES-BENZ service station, although this can be carried out by 2 persons. The roadster top must be completely dry before it is placed in the storage compartment.

To lower or raise the folding top or to remove or attach the hardtop, find two locking handles in a bag stowed in the glove compartment. They are used to engage or disengage the locks in windshield header bar and behind the doors (8). Put locking handles back into the glove compartment after use.

The hardtop is secured at 5 attachment points:

Front = two locks in windshield header bar

Side = one lock behind each door (8)

Rear = top bow lock

Removal of hardtop:

1. Disengage rear locks with levers (1 and 7). (Lever 1 in position B, lever 7 in position E.)
2. Turn side locks (8) rearwards to the stop with locking handles.

3. Insert locking handles into windshield header bar locks and swivel inwards. Detach locking handles.
4. Disconnect plug and socket of the heated rear window in the R-H rear passenger compartment.
5. Cautiously detach hardtop by removing it to the rear.

Attaching hardtop:

1. Shift lever (1) to position B and lever (7) to position D.
2. Carefully position hardtop, simultaneously inserting all locking pins into the respective locks.
3. Insert both the locking handles into the forward locks and swing outwards.
4. Insert locking handles into side locks (8) and swivel forward to the stop.
5. Push lever (1) to position A.
6. Connect plug and socket of the heated rear window in the R-H rear passenger compartment.

## Hardtop

The roadster top may become moldy if it is kept enclosed in the storage compartment for an extended period. We recommend you to have the roadster top removed in a MERCEDES-BENZ service station if you intend to drive only with the hardtop for a lengthy period. Should the roadster top, however,

be kept in the car, unfold and air it thoroughly (do not expose to the sun) at regular intervals during the wet and cold seasons. A special container for the storage of roadster tops or hardtops is available from your MERCEDES-BENZ service station.

## Sliding Roof (450 SLC)

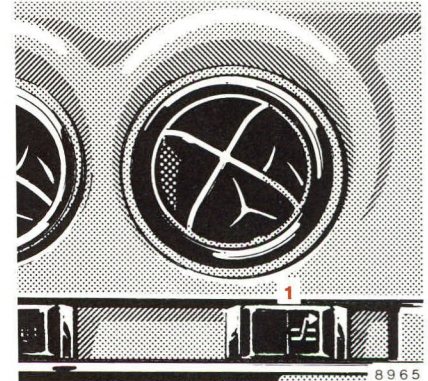

Toggle switch (1) next to glove compartment.

Push at the right (symbol) =  
Opening

Push at the left = Closing

If the electric drive fails, the sliding roof can also be moved by hand. Refer to "Sliding Roof-Emergency Operation".

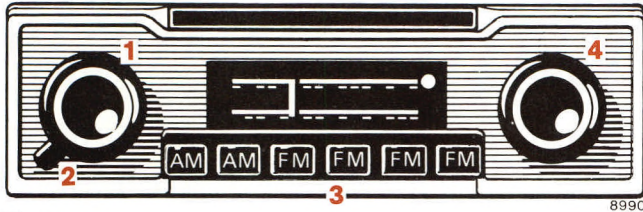

Europa  
(Radio with Pushbutton Tuning)

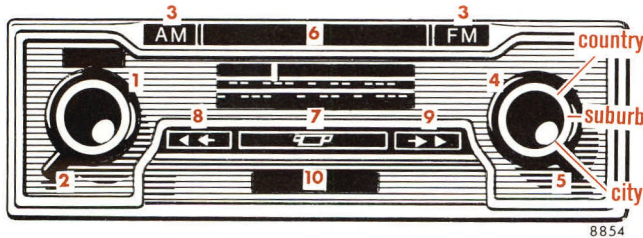

Mexico Cassette  
(Radio with Automatic Signal Seeker  
and built-in Cassette Player)

- 1 On-Off/Volume Control
- 2 Tone Control
- 3 Push buttons for band selection and tuning of preset stations (band selection only on radios with built-in cassette player)
- 4 Manual tuning control
- 5 Search sensitivity switch
- 6 Automatic tuning bar (Mexico models only)
- 7 Cassette release
- 8 Fast forward
- 9 Fast rewind
- 10 Cassette slot

For control location, refer to the illustration on the type of radio installed in your MERCEDES-BENZ. The radio can only be operated with the ignition key in the number "1" or "2" position.



## Radio

---

### On-Off/Volume

Turn knob (1) clockwise to switch radio on and to increase volume. Green control lamp on the dial will light up.

### Tone

Turn lever (2) clockwise to increase treble range and counterclockwise to increase bass range.

### Front-Rear Speaker Balance (450 SLC)

This control is installed whenever the vehicle is equipped with rear speakers. Turn rearward to increase volume of rear speakers and forward to increase volume of front speakers.

### Station Tuning

First, select desired band by pressing one of the AM or FM station buttons (3), then tune manually by turning control knob (4). For good reception, accurate manual tuning is important.

To preset stations on pushbutton tuning radios in either the AM or FM band, pull station buttons (3), carefully tune in the desired station, push button slowly and firmly all the way in, then release.

Automatic station tuning (on signal seeking radios only) is accomplished by momentarily depressing the "Automatic Tuning" bar (6). The tuner moves from the left towards the right side of the dial and stops whenever a useable station is found.

Operating the automatic tuning bar again causes the tuner to resume its search function. When the end of the band is reached, the tuner will automatically return to the beginning of the band and start the search operation again.

The position of the search sensitivity switch (5) determines whether the tuner will stop at many or the most powerful stations only.

- |                         |   |
|-------------------------|---|
| Position I<br>"country" | Selector stops at every useable station       |
| Position II<br>"suburb" | Selector stops only at more powerful stations |
| Position III<br>"city"  | Selector stops only at the strongest stations |

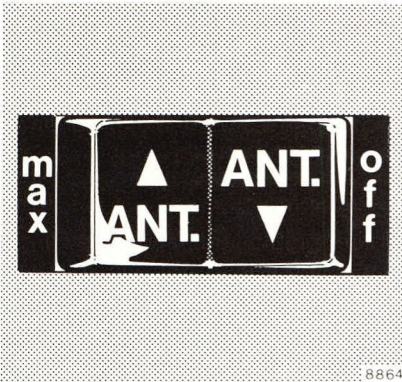

### Automatic Antenna

The antenna switch can be actuated with the radio switched on and the key in steering lock positions “1” or “2”.

- If the antenna switch is in center position, the antenna extends automatically to a specific height,
- if the antenna switch is engaged in the “max.” position, the antenna extends fully,
- if the antenna switch is engaged in the “off” position, the antenna will not extend or will retract completely.

The height of the antenna can furthermore be adjusted continuously by actuating the antenna switch:

- If the antenna switch is in center position, the antenna will extend to the specific height. The antenna can be further extended or retracted to any height by rocking the switch (not engaging it).
- If the antenna is to be retracted, e. g. for playing cassettes, engage switch in “off” position.

When the key is turned to steering lock position “0” or the radio is turned off, the antenna will retract completely.

### FM Reception

FM signals travel in a “line-of-sight”. Reflections or “dead spots” may cause cancellations or loss of the signal as well as strong signal overloading or capture.

Lowering the antenna height in strong signal areas may eliminate many of the resulting problems and

restore good tone quality. However, fringe area reception requires the full antenna length to capture weak incoming signals. The antenna can be operated by depressing the respective side of the rocker switch.

### FM Stereo Reception

When tuned to a FM stereo station, the red Stereo Indicator Lamp will light up. Because more information is carried in the FM stereo signal than in FM monoraul broadcasts, flutter, cancellation and capture effects may be even more noticeable. The noise-free broadcast range, therefore, is somewhat less and accurate tuning to the strongest available stereo stations is required, especially for fringe area reception.

Your radio is equipped with a specially designed Stereo Decoder which automatically switches the radio from stereo to mono reception if the signal becomes too weak. However, the Stereo Indicator Lamp remains lit to avoid the distracting flicker at short-time signal changes. The radio will return to the stereo mode automatically when signal strength permits it.

## Radio

---

### Tape Playback (Mexico Cassette Model)

This type of radio provides for the playback of prerecorded stereo music through the unique combination of all the features of an automatic signalseeking stereo radio with a tape player.

To start playback, insert stereo cassette through the swing-away door of the cassette slot and depress until the mechanism engages. (Note: Full reel on the right tape side of cassette first.)

The cassette will be automatically released when the tape reaches its end. To play the other side, remove the cassette from the radio, turn it upside down and reinsert through the slot. To manually eject the cassette, push the release bar (7). When the cassette is ejected, the unit will automatically switch to radio reception.

For fast forward or rewind of the tape, depress button 8 or 9 past point of resistance. To stop tape winding, depress opposing button to point of resistance only.

### Care of the Tape Player

Use only good quality cassettes with a maximum playing time of 45 minutes per side (C 90). "Unwound" tapes can be fixed by rewinding either reel with a pencil inserted in its hub. The pick-up head and roller should be cleaned occasionally to maintain the original high quality sound reproduction.



# Driving



## Hood

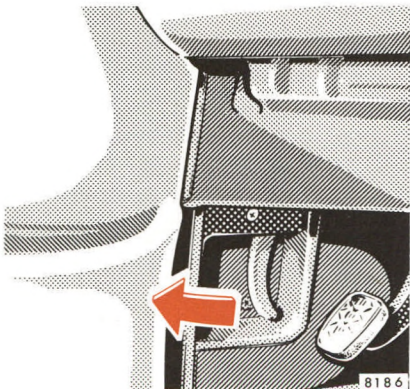

To open, pull handle (below the L-H side of instrument panel) to unlock it. The hood opens to the safety catch stop. Pull lever in radiator grille as indicated by the

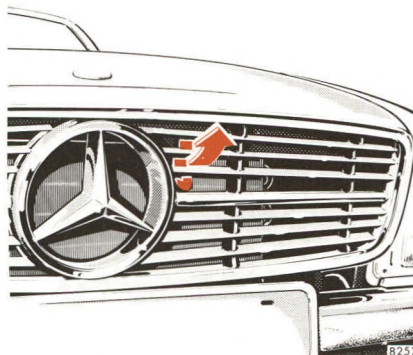

arrow and lift hood (windshield wiper arms must not be folded out). To close, press down hood firmly.

Note:

There is a risk of injury when the hood is open and the engine is running.

## Parking Brake

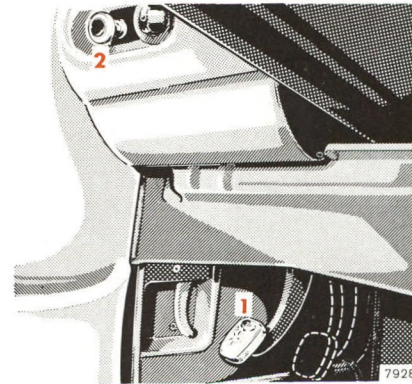

Depress parking brake pedal (1). When the steering lock key is in position "2", the brake warning lamp in the instrument cluster comes on.

To release, pull release button (2) on the instrument panel. The parking brake releases in one rapid movement. The parking brake warning lamp in the instrument cluster must go out.

## Have the following items checked regularly and prior to any long trip

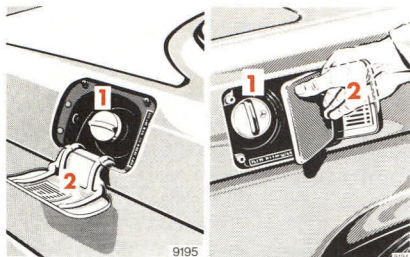

### 1 Fuel Supply

Use unleaded gasoline, for octane rating see "Capacities and last page". Do not force fuel tank flap.

### 2 Tire Pressure

For tire pressure table refer to fuel filler flap or last page. Check at least every other week. For more details see "Wheels, Tires, Changing Wheels".

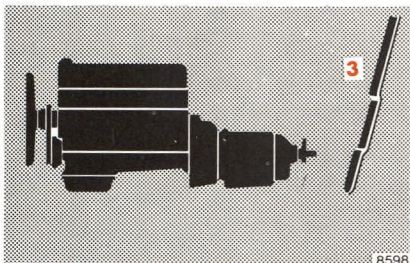

### 3 Oil/Fluid Level: Engine, Automatic Transmission

See "Checking Fuels, Coolants, Lubricants, etc.", "Fuels, Coolants, Lubricants, etc. and last page".

### 4 Coolant Level

See "Checking Fuels, Coolants, Lubricants, etc.", "Fuels, Coolants, Lubricants, etc. and last page".

### 5 Brake Fluid

When the minimum mark on the reservoir is reached, have the system checked (brake lining thickness, leaks).

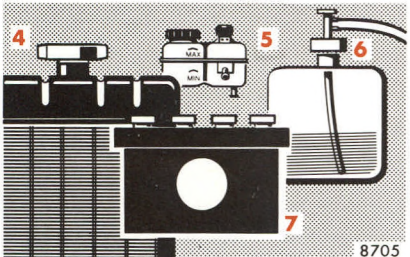

### 6 Windshield Washer

Replenish with water mixed with windshield washer detergent (container is in the engine compartment).

### 7 Battery

Replenish with distilled water only. See "Electrical System".

### Vehicle Lighting

Check for function and cleanliness.



## Catalytic Converter Cautions

---

Your MERCEDES-BENZ is equipped with monolithic catalytic converters, an important element in conjunction with the O<sub>2</sub>-sensor to achieve substantial control of the pollutants in the exhaust emissions. Keep your vehicle in proper operating condition by following our recommended maintenance instructions as outlined in your maintenance booklet.

Should any noticeable irregularities in the engine operation occur such as misfiring of one or more cylinders, indicated by audible signs, excessive unburned fuel may reach the converter causing it to

overheat. Continued operation of your vehicle can result in damage to the converter.

### **For the same reason we caution against:**

- Misuse or abuse of your vehicle engine
- Refueling with leaded gasoline
- Excessive idling with cold engine
- Push or tow starting your vehicle with hot engine.

As with any vehicle, do not idle or park or operate this vehicle in areas where combustible materials such as grass, hay or leaves can come into contact with a hot exhaust system, as these materials could be ignited.

We urge your cooperation by following the above instructions to achieve cleaner air.

Engage parking brake or service brake before starting the engine.

Place the gear selector lever in either “N” or “P” position before starting the engine.

Turn key in steering lock to position “2”. The charge indicator lamp must come on.

### Cold Engine

Turn key in steering lock clockwise to the stop. If necessary, depress the accelerator slowly after the engine has started firing. Release key only when the engine is running smoothly.

### Hot Engine

Turn key in steering lock clockwise to the stop. Do not actuate accelerator. If the engine has not fired after approx. 4 seconds, depress

accelerator to the floor and continue cranking until the engine runs smoothly. Release key and back off accelerator after the engine has started.

### Cold Start at Normal Ambient Temperatures (about 15° C – 35° C / 59° F – 95° F)

Turn the key in steering lock clockwise to the stop. Start without actuating accelerator. Release key only when the engine is running smoothly.

### Turning off

Turn the key in the steering lock to position “0” and only remove the key when the vehicle is at standstill.

If the coolant temperature is very high (e.g. after hard driving on mountain roads), do not shut off the engine immediately but allow it to run on for 1–2 minutes at increased idle speed.

### Hints

Observe the oil pressure gauge immediately after starting the engine. In a very cold engine the oil pressure will only rise slowly, some time after the engine has started. Do not rev up the engine before pressure is registered on the pressure gauge.

The charge indicator lamp must go out as soon as the engine has started.

Do not engage the starter continuously for more than 20 seconds.

At ambient temperatures of less than –20° C / –4° F, depress the accelerator three times prior to starting.

## Starting and Shifting Gears

Do not store any objects in the driver's footwell area because they could become lodged under the operator's pedals thus rendering these controls partially or totally inoperative.

Test service brake after driving off. Warm up the engine smoothly. Do not place full load on the engine until the operating temperature has been reached.

The automatic transmission facilitates and simplifies the handling of the vehicle. The individual gears are shifted automatically dependent upon selector lever position, vehicle speed and accelerator position.

### Hint

When parking the vehicle or if working on the vehicle with the engine running, depress parking brake pedal and move selector lever to position "P".

### Starting

Shift selector lever to the desired driving position only when the engine is idling and the service brake is applied. Do not release the

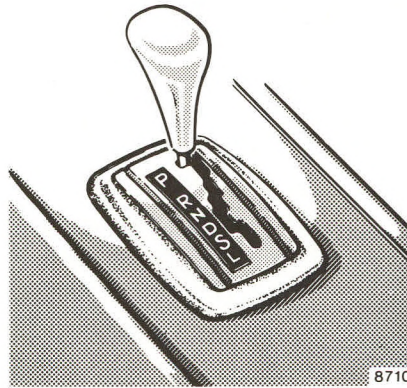

brake before moving off. The vehicle may otherwise start creeping when the selector lever is in a driving position.

### Accelerator position

Partial throttle = early upshifting  
= normal acceleration

Full throttle = retarded upshifting  
= maximum acceleration

Depressing the accelerator beyond full throttle to kickdown position means downshifting to the next lower gear and thus maximum acceleration. If you ease up on the

accelerator after having attained the desired speed, the transmission will shift up again.

Gearshifting is controlled by the vehicle speed.

### Selector Lever Positions

The automatic gear shifting process can be adapted to specific operating conditions by means of the selector lever.

"P" Parking lock. The parking lock is an additional safeguard when parking the vehicle. Engage only when the car is stationary.

"R" Reverse gear. Shift reverse gear only with the vehicle at halt.

"N" Neutral. No power is transmitted from the engine to the rear axle. When the brakes are released, the vehicle can be moved freely (pushed, towed or towstarted). Do not engage "N" when driving except when the vehicle is in danger of skidding (e. g. on icy roads). See page 44.



### “D” Drive.

All gears are available. The vehicle starts out in 1st gear. Position “D” affords optimum driving characteristics under all normal operating conditions.

### “S” Slope.

Upshifting to 2nd gear only. The vehicle starts out in 1st gear. Suitable for moderate ascents and descents. As the transmission shifts up to 2nd gear only, this position permits the utilization of the engine braking effect. With the selector lever in position “S” and the accelerator depressed to full throttle, 1st gear covers a wider speed range than with the selector lever in position “D”.

### “L” Low.

No upshift, transmission will remain in 1st gear. For driving on steep mountain passes, for trailer operation in mountainous regions, for driving under severe operating conditions and as a braking position on extremely steep declines.

### Maneuvering

To maneuver in restricted area, e. g. when pulling into a parking space, control the car speed by gradually releasing the service brake. Accelerate gently and do not pump the accelerator. To rock a car out of soft ground (mud or snow), alternately shift one forward gear range and the reverse gear at partial throttle.

### Trailer operation

Do not allow the engine speed to drop too low at uphill gradients to prevent the engine from laboring at low RPMs. Depending on the

degree of the incline, shift selector lever to positions “S” or “L” early enough to maintain engine rpms within best torque range.

### Stopping

For brief halts, e. g. at traffic lights, leave the selector lever in a driving position and control vehicle with the service brake.

For longer stops with the engine idling, shift selector lever to position “N”.

When stopping the car on a slope, do not hold it by means of the accelerator but use the brake. This avoids unnecessary heat-up of the transmission.

## Safe Driving

---



Always drive according to the rule “Safety first”. The comfortable ride of the vehicle may easily tempt you to underestimate the speed you are actually driving at. For this reason you should get used to keeping an eye on the speedometer needle because high speeds demand long stopping distances. Do not attempt to move or roll the vehicle with the engine not in operation, as engine-driven accessories such as the power steering system or power brakes are not “powered”, therefore, requiring substantially more effort for their operation even though they always remain mechanically operative.

Do not allow your tires to wear down too far. With less than approx. 3 mm /  $\frac{1}{8}$  in of tread, the antiskid properties on a wet road fall off sharply.

Depending upon the weather and/or road pavement, the grip of the tires varies widely.

The retention of the specified tire pressure is essential. This applies particularly if the tires are subjected to high loads (e.g. high speeds,

heavy loads, high ambient temperatures).

**Aquaplaning:**

Depending on the depth of the water layer on the road, aquaplaning may occur even with tires still showing the full tread depth, and even at low speeds. Avoid track grooves in the road and apply brakes cautiously in the rain.

**Tire friction:**

Dry road = 100 %

Wet road = from approx. 50 % to approx. 80 % (be particularly cautious on wet and dirty roads)

Icy road = approx. 15 %

A given speed at which a vehicle driven on dry roads can still be fully controlled must be reduced when the same vehicle is to be driven safely on a wet or icy road.

You should pay particular attention to the condition of the road as soon as the prevailing temperatures fall close to the freezing point. If ice has formed on the road (e. g. due to fog), a thin film of water is then quickly produced on the ice which substantially reduces the grip of

the tires. Under such weather conditions, drive, steer and brake particularly carefully.

We recommend M+S radial-ply tires for the cold season. On ice or packed snow, they can reduce your stopping distance as compared with summer tires. Stopping distance, however, is nevertheless considerably greater than when the road is wet or dry.

When driving down long and steep declines, relieve the brakes by engaging selector lever position “S” or “L”. This prevents overheating of the brakes and reduces brake pad wear.

After hard braking it is advisable not to switch off the engine right away but to drive on for some time so the air stream will cool down the brakes faster.

When driving in heavy rain for some time without applying the brakes, the first braking action may be somewhat retarded and increased pedal pressure may be necessary. For this reason, stay further away from vehicle in front.



The condition of the parking brake will be checked during every maintenance service. Furthermore it is recommended to exert once or twice between the regular maintenance services, a maximum pressure of 10 kp/22 lb on the parking brake pedal for 10 seconds while travelling at a speed around 50 km/h/30 mph on dry road. Pull release knob during this process! Repeat procedure once or twice. Exercise care, the stoplamps do not work. Have all inspections of and work on the brake system carried out by a MERCEDES-BENZ service station. If the parking brake is released and the brake warning lamp in the instrument cluster comes on, the brake fluid level in the reservoir is too low.

A leak or brake pad wear may cause a shortage of brake fluid in the reservoir.

Have brake system checked in a MERCEDES-BENZ service station as soon as possible. Install only brake pads recommended by us.

If other than recommended brake pads are installed, the braking properties of the vehicle can be affected to an extent that the safety is substantially impaired.

### **Brake Pad Wear Indicator Lamp**

The brake pad wear indicator lamp in the instrument cluster comes on when the key in the steering lock is turned to driving position "2" and it must go out when the engine is running. If the indicator lamp lights up during braking or driving, this shows that the front wheel brake pads are worn down.

Have brake system checked in a MERCEDES-BENZ service station as soon as possible.

### **Brake Fluid**

During the course of the operation of the vehicle, the boiling point of the brake fluid is continuously being reduced through the absorption of moisture from the atmosphere. Under extremely hard operating conditions, this moisture content can lead to the formation of vapor in the system thus reducing the system's efficiency. The brake fluid must therefore be replaced annually, preferably in the spring. It is recommended to use only brake fluid approved by MERCEDES-BENZ.

Your MERCEDES-BENZ dealer will provide you with additional information.

### **Charge Indicator Lamp**

Should the charge indicator lamp fail to come on prior to starting when the ignition key is in position "2" or should it fail to go out after starting or during operation, this indicates a fault which must be repaired at a MERCEDES-BENZ service station as soon as possible.



### **Oil Pressure Gauge**

The oil pressure may drop at idle speed to 0.5 bar/7.1 psi if the engine is at operating temperature. This will not jeopardize its operational reliability. Pressure must, however, rise immediately upon acceleration.

The oil pressure gauge does not provide any information concerning the oil level in the engine.

### **Coolant Temperature Gauge**

Due to the pressurized cooling system, the coolant only starts boiling at a temperature of approx. 125° C/257° F with an antifreeze-blended coolant fill protecting down to -30° C/-22° F (see also "Fuels, Coolants, Lubricants, etc.").

During severe operating conditions and stop-and-go city traffic the coolant temperature must not rise above the red marking.

### **Emission Control**

Certain systems of the engine serve to keep the toxic components of the exhaust gases within permissible limits required by law. (Nevertheless, we urgently advise you not to let the engine run in a closed garage.) These systems, of course, will function properly only when maintained strictly according to factory specifications. Any adjustments on the engine should, therefore, be carried out only by qualified MERCEDES-BENZ technicians. The adjustments of the engine should not be altered in any way. Moreover, the specified service and maintenance jobs must be carried out regularly according to MERCEDES-BENZ servicing requirements. For details refer to Owner's Emission Control and Maintenance Manual.

### **Engine Oil Consumption**

Engine oil consumption can only be determined after a certain mileage has been covered. During the break-in period, higher oil consumption may be noticed and is normal. Frequent high engine speed operation will also cause increased oil consumption.

## The First 1500 km/1000 Miles

---

The more cautiously you treat your engine during the break-in period, the more satisfied you will be with its performance later on. Therefore, drive your vehicle during the first 1500 km/1000 miles at moderate vehicle and engine speeds.

During this period, avoid heavy loads (full throttle driving) and high RPMs (no more than  $\frac{2}{3}$  of maximum permissible speed in each gear) and do not force the engine to labor at low engine speed.

Avoid accelerating by kickdown. It is not recommended to brake vehicle by means of manually shifting to a lower gear. We recommend to select positions "S" or "L" only at moderate speeds (for hill driving).

After 1500 km/1000 miles speeds may gradually be increased to the permissible maximum.

## Special Operating Conditions

---

### Winter Driving

Have your car winterized in a MERCEDES-BENZ service station before the onset of winter.

- Engine oil change: If no "all year round" engine oil is used, fill with recommended winter oil. For viscosity and capacity refer to "Fuels, Coolants, Lubricants, etc. and last page".
- Antifreeze in the coolant: Check antifreeze protection periodically. For capacity refer to "Fuels, Coolants, Lubricants, etc."
- Additive in the windshield washer system: Add windshield washer solvent to the water in the windshield washer system.
- Test battery: Battery capacity drops with decreasing ambient temperature. A well charged battery ensures that the engine can always be started, even at low ambient temperatures.
- Tires: For the cold season we recommend mounting M+S radial-ply tires on all wheels. Permissible top speed for M+S radial-ply tires is 160 km/h/100 miles/h.

## Special Operating Conditions

---

### Hints for Driving

The most important rule for slippery or icy roads is to drive sensibly and to avoid abrupt acceleration, braking and steering action. Do not use the cruise control system under such conditions.

When the vehicle is in danger of skidding, move selector lever to position "N". Try to keep the vehicle under control by means of corrective steering action.

Provided the traffic conditions will allow, only brake in a way that the wheels are locked for no more than fractions of a second as otherwise the steerability of the vehicle is lost.

Thawing salts and water can adversely affect the braking efficiency. Increased pressure on the pedal may be required to achieve the usual

braking effect. We therefore recommend you to actuate the brakes repeatedly in order to test their efficiency after driving on salt treated roads for some time. In doing this it must, of course, be made sure that no danger is created for other road users.

If the vehicle is parked after being driven on salt treated roads, the braking efficiency should be tested as soon as possible after driving is resumed while adhering to the safety requirements. Should the braking efficiency have deteriorated considerably it can be improved again by braking several times.

### Tire Chains

Tire chains can only be used on the driving wheels. Use only chains tested and recommended by us. Any MERCEDES-BENZ service station will readily advise you. Retighten newly mounted tire chains after a few miles of driving. Do not exceed permissible maximum speed of 50 km/h/30 mph. On clear roads, remove the chains as soon as practicable. Adhere to the manufacturer's mounting instructions.

### Traveling Abroad

Abroad, too, there is a widely-spread MERCEDES-BENZ service network at your disposal. If you travel into areas which are not listed in the index of your service station booklet, you should request pertinent information from your dealer.



# Vehicle Care



Like any other mechanical equipment, the vehicle requires care and maintenance.

A maintenance booklet is delivered with your car listing all the maintenance jobs that must be carried out after the following mileages:

- Once after 1300–1600 km/800–1000 miles.
- Once after 12 000 km/7500 miles.
- After 24 000 km/15 000 miles and thereafter every 24 000 km/15 000 miles, but at least once every two years.

We would also like to draw your attention to the hints contained in the maintenance booklet covering necessary lubrication service every 12 000 km/7500 miles, additional maintenance jobs every 48 000 km/30 000 miles and MB individual maintenance as required.

Renew brake fluid once a year, preferably in spring. Use only brake fluids recommended by MERCEDES-BENZ.

The vehicle must receive the prescribed maintenance and/or lubrication work at the specified intervals as listed in the maintenance booklet. Verification of performance of such maintenance/lubrication work should be recorded in the spaces provided in the maintenance booklet.

The maintenance jobs are described in detail in a manual which you can order from your MERCEDES-BENZ service station.

A small sticker attached to the door post of the driver's door by the service station personnel is to remind you when the next maintenance service or lubrication service is due.



Lubrication service



Maintenance service

### Severe Operating Conditions

In the case of severe operating conditions or heavy use mainly in city traffic or over short distances, frequent mountain driving, poor roads, dusty and muddy conditions, trailer operation, hard and sporty driving, etc. it may be necessary to inspect e.g.

- the front axle brake linings
- the tires
- air cleaner (clean or renew element)

at shorter intervals.

Any MERCEDES-BENZ service station will be pleased to give you expert and individual advice.

## MERCEDES-BENZ Maintenance System

---

### Engine Oil Change and Filter Change

To be carried out every 12 000 km/ 7500 miles, but at least once a year if year-round multigrade oil is used. Otherwise at least twice a year (in spring and fall).

Under severe operating conditions the oil should be changed every 6000 km/3750 miles. It is not mandatory to change the filter at this oil change.

For regular oil level checks, refer to "Checking Fuels, Coolants, Lubricants, etc."

### Automatic Transmission – Fluid and Filter Change

To be carried out every 48 000 km/ 30 000 miles according to the maintenance booklet.

Under severe operating conditions, have the automatic transmission fluid changed every 24 000 km/ 15 000 miles without filter change.

## Spare Parts Service

---

All MERCEDES-BENZ service stations store the MERCEDES-BENZ original spare parts required for maintenance and repair work. In addition, depots are provided all over the globe intended to ensure the rapid supply of MERCEDES-BENZ original spare parts.

More than 200 000 different spare parts, even for rather old vehicle models, are furthermore stocked in the central plant warehouses.

We warrant maximum operational efficiency and reliability as well as optimum retention of the vehicle value when MERCEDES-BENZ original spare parts are installed, as they are subjected to most severe quality inspections. Each part has been specifically developed, manufactured or selected for and adapted to MERCEDES-BENZ vehicles.

For this reason, only MERCEDES-BENZ original spare parts should be installed.



## Cleaning and Care of the Vehicle

---

In operation, your vehicle is subjected to a great amount of varying external influences which, if gone unchecked, can attack the paint-work as well as the underbody and cause lasting damage.

Such damage is caused not only extreme and varying climatic conditions, but also by air pollution, road salt, tar, gravel and stone chipping. Grease and oil, fuel, coolant, brake fluid, bird droppings, tree resins, etc. should be immediately removed to avoid paint damage. Frequent washing, however, reduces and/or eliminates the aggressivity and potency of the above adverse influences.

Special car-care measures may be necessary to deal with unfavorable conditions; for example, near the coast, in industrial areas (smoke, exhaust emissions), or during winter operation.

You should check over your vehicle from time to time for stone chipping or other damage. Any damage should be repaired as soon as possible.

In doing so, do not neglect the underside of the car. A prerequisite for a thorough check is a washing of the underbody followed by a rustproofing treatment.

Your vehicle has been treated at the factory with a wax-base rustproofing in the body cavities.

After every engine cleaning you should have the engine compartment rustproofed. Before rustproofing, all control linkage bushings have to be lubricated with hydraulic oil (check with your local MERCEDES-BENZ dealership for recommended brands).

We have selected car-care products and compiled recommendations which are specially matched to our vehicles and which always reflect the newest in technological standing. You can obtain MB car-care products at every MERCEDES-BENZ service station.

Scratches, corrosive deposits, corrosion or damage due to negligent or incorrect care cannot always be removed with the car-care products recommended here. In such cases it is best to seek aid at your MERCEDES-BENZ service station.

The following topics deal with the cleaning and care of your vehicle and give important "how-to" information as well as references to recommended MB car-care products.

### Car Wash

Before washing your vehicle, remove insect residues. The car should not be washed in the sun.

Thoroughly spray the car with a diffused jet of water. Direct only a very weak spray towards the ventilation intake. Use plenty of water and rinse the sponge and chamois frequently. Rinse with clear water and thoroughly wipe dry with a chamois.

If the vehicle has been run through an automatic car wash – in particular one of the older installations – rewipe the recessed sections provided in the tail lamps (for improved prevention of soiling) if necessary. No solvents (fuels, thinners etc.) must be used.

In the winter, thoroughly remove all traces of road salt as soon as possible.

When washing the car underbody, do not forget to clean the inner sides of the wheels.

### Tar Stains

Quickly remove tar stains before they dry and become more difficult to remove.

### Window Cleaning

Use a window cleaning solution on very dirty or oil-stained windows. Clean windshield wiper blades with a clean cloth and washing solution. Replace blades once or twice a year.

### Plastic (Vinyl) and Rubber Parts

Do not use oil or wax on these parts.

### Seat Belts

The webbing must not be treated with chemical cleaning agents. Use only clear, lukewarm water and soap. Do not dry the webbing at temperatures above 80° C/176° F or in direct sunlight. Never bleach or re-dye the webbing.

### Steering Wheel, Instrument Cluster and Selector Lever

Use a gentle dish-washing detergent or mild detergent for delicate fabrics as a washing solution. Wipe with a cloth moistened in lukewarm solution. Do not use scouring agents.

### Upholstery

Leather: Wipe leather upholstery with a damp cloth and dry thoroughly. Exercise particular care when cleaning perforated leather as its underside should not become wet.

Velours: Pressure marks resulting from dampness and heat may appear to be stains. Such marks can be removed by wiping with a moistened brush, ironing with a wet cloth or by treating with a dry shampoo. Do not sit on damp upholstery. Quick drying is achieved by applying hot air – for example, by using a hair dryer. If in doubt, please consult your MERCEDES-BENZ service station.

## Cleaning and Care of the Vehicle

---

### Paintwork

Do not apply wax if your car is parked in the sun or if the hood is still hot. For maximum protection, the paintwork should be waxed approximately once every three months. Use the appropriate MERCEDES-BENZ Touch-Up Stick for quick and provisional repairs of minor paint damage.

### Light Alloy Wheels

If possible, clean wheels once a week with lukewarm water and autoshampoo. Use an ample supply of water.

To remove stubborn marks, use polish or paint cleaner and apply with buffing cloth or a soft cloth.

### Ornamental Moldings (Chrome-Plated, Aluminium)

For regular cleaning and care of very dirty chrome-plated parts, use a chrome cleaner.

### Roadster Top

(Rubber-coated Canvas)

Stow only a completely dry top in the storage compartment. If the top is kept in the storage compartment for a lengthy period, unfold and air it well with the windows down from time to time.

Remove bird droppings immediately. The organic acid swells the rubber and causes the top to leak.

In general regular spraying or cleansing with clear water will do. Wash top only when heavily soiled, not every time the car is washed.

Caution: Never use any gasoline, thinner, tar and stain removers or similar organic solvents to clean top or rear window.

Dry cleaning:

Brush top (always from front to rear) with a soft-bristled brush.

Wet cleaning:

Brush the dry top. Wash with a mild detergent and an ample supply of lukewarm water by wiping the canvas with a soft-bristled brush or a sponge from front to rear. Then cleanse thoroughly with clear water.

If only parts of the top have been washed, wet the entire top at the end of the proceedings and allow the unfolded and tightened top to air-dry. Wipe the rear window with a cloth soaked with a detergent and rub dry. Do not use sharp-edged instruments for the removal of ice and snow.

Important!

The seams of the top may start to leak due to improper care and cleaning, as well as due to usage over a long period of time. A resealing of the top seams can be carried out at every MERCEDES-BENZ service station.



# Practical Hints



## Practical Hints

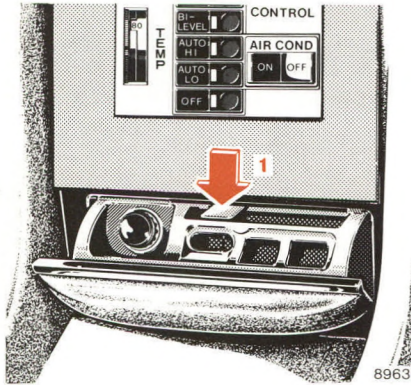

### Ash trays

Removal of front ash tray:  
Pull out ash tray up to the stop.  
Depress center locking spring (1)  
and remove ash tray.

To install ash tray:  
Position ash tray squarely and  
push in.

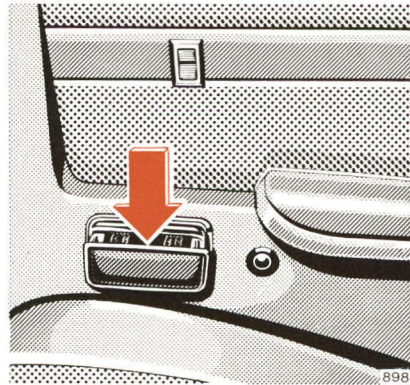

Removal of rear ash tray (450 SLC):  
Press down ash tray when opening  
it and remove it.

To install ash tray:  
Position ash tray squarely and  
push in.

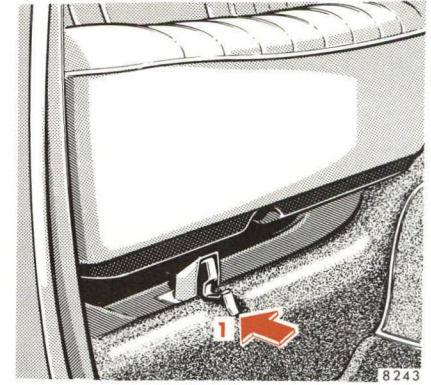

### Rear Seat Cushion (450 SLC)

Removal: Push in left and right  
spring clamps (1), slightly raise  
rear seat cushion at the front side  
and pull toward the front.

Installation:  
Push rear end of rear seat cushion  
under rear seat back as far as it  
will go and press seat cushion front  
section downward until it rests on  
the cushion support.

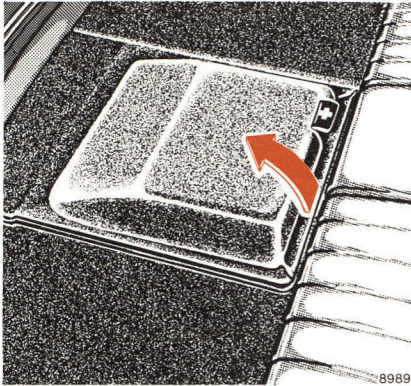

### First Aid Kit

The first aid kit is stowed in a cavity in the hat shelf at the rear.

### Luggage or Ski Racks

The only type of rack to be mounted on the roof we recommend is the drip rail mounted type which has no other supports (suction cups or legs) to support the rack on the roof. Such supports may lead to marring of the paint or even denting of the roof if excessive weight is placed on the rack. Your MERCEDES-BENZ dealer can give further advice.

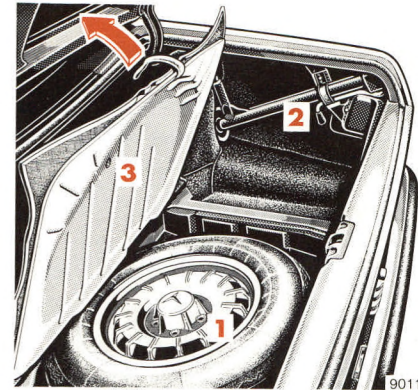

### Spare Wheel, Jack, Vehicle Tool Kit

Spare wheel (1) is stowed in a trough below the folding trunk floor (3).

Jack (2) and tools are located in the trunk on the right side.

Note:

The jack is designed exclusively for jacking up the vehicle at the jack tubes provided on either side of the vehicle. Jack stands must be used when working under the vehicle.



### Wheels and Tires

In case of replacement we recommend you use tires of identical design, version and brand.

See any MERCEDES-BENZ service station for information on tested and recommended wheels and tires for summer and winter operation. They will also offer more advice concerning tire service and purchase.

Mount single newly acquired tires on the front wheels. If any tires are replaced and the spare tire is new and of the same make and version, mount the spare wheel on the vehicle as road wheel. We recommend that you break in new tires for approx. 100 km/60 miles at moderate speed.

For tire specifications, refer to "Technical Data".

#### Rotating wheels:

The wheels can be rotated according to the degree of tire wear while retaining the same sense of rotation. Rotating, however, should be carried out before the characteristic tire wear pattern (shoulder wear on

front wheels and tread center wear on rear wheels) becomes visible at a mileage of 5000–10 000 km/ 3000–6000 miles as otherwise the driving properties deteriorate.

Slowly leaking air (e.g. due to a nail in the tire) may cause damage to the tire such as tread separation. Regular tire pressure checks at intervals of no more than 14 days are therefore essential. For the tire pressure checks, keep in mind that hot tires show higher pressure than cold tires. See tire pressure chart on last page.

Should the tire pressure decrease constantly, check whether foreign objects have penetrated the tire or if rim or valve allow the air to leak.

Thoroughly clean the inner side of the wheels any time you rotate the wheels or wash vehicle underside.

Dented or bent rims cause tire pressure loss and damage to the tire beads. For this reason, check rims for damage at regular intervals.

The rim flanges must be checked for wear before a tire is mounted. Remove burrs, if there are any.

Observe wheel bolts!

- 1 For forged light alloy rims only
- 2 For steel rims only

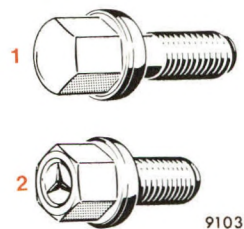

#### Caution:

Do not use the long wheel bolts (1) intended for light alloy wheels only when mounting steel rims. Use only the shorter bolts (2) for the steel rims.

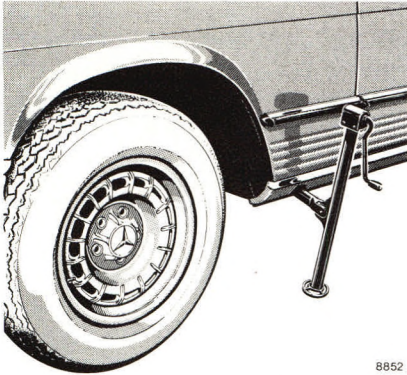

8852

### Changing Wheels

1. Depress parking brake pedal.
2. Move selector lever to position "P".
3. Safeguard vehicle against rolling off by using chocks or similar. Place chocks under both opposite wheels (on downhill side), on a level road on both sides of the opposite front wheel when changing a rear wheel.
4. Using the combination wrench, loosen but do not yet remove the wheel bolts.
5. Clean jack supporting tube, if necessary. (Jack tubes are behind the front wheel housings and in front of the rear wheel housings.)
6. Insert jack arm into the tube hole up to the stop. Position the jack so that it will always be vertical as seen from the side, even on inclines. Jack up the vehicle until the wheel is clear of the ground.
7. Then back out the wheel bolts. Protect bolt threads from dirt and sand. Remove the wheel.
8. Adjust the jack to allow the wheel to be slipped on without being lifted.
9. Slip on wheel and press against wheel mounting flange. Turn in wheel bolts.

10. Lower car and remove jack. Tighten the five bolts evenly by going around the wheel and tightening every other bolt until all the bolts are tight. Observe a tightening torque of 10 mkp/ 72 lb–ft.
11. Correct tire pressure.

### **Tire Inflation Pressure**

A table (see fuel filler flap or last page) lists the tire inflation pressures specified for summer and winter tires as well as for the varying operating conditions.

Tire pressures listed for light loads are minimum values offering high driving comfort. Increased inflation pressures for heavy loads produce favorable handling characteristics with lighter loads and are perfectly

permissible. The ride of the vehicle, however, will become somewhat harder.

Tire temperature and pressure increase with the vehicle speed. Tire pressure should therefore only be corrected on cold tires. Correct tire pressure in hot tires only if pressure has dropped below the data listed in the table and the respective operating conditions are taken into consideration.



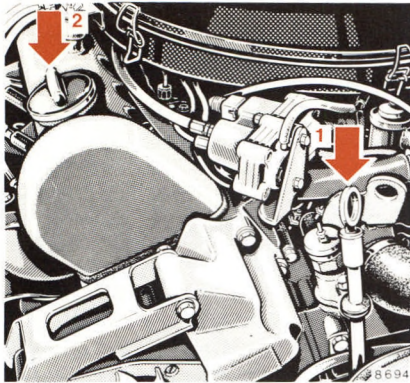

### Engine Oil Level Check

- 1 Dipstick
- 2 Oil filler hole

Check engine oil level at regular intervals, e. g. after refueling, with the engine at operating temperature and shut off.



The vehicle should be parked on level ground and the oil level must be somewhere between the lower and the upper mark on dipstick (1); do not replenish in excess of the upper mark.

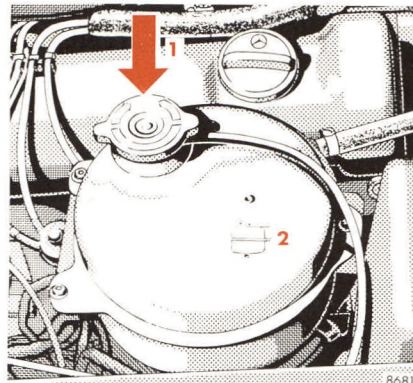

For viscosity and capacity, see “Fuels, Coolants, Lubricants, etc., and last page”.

### Replenishing Coolant

- 1 Coolant Filler
  - 2 Marking for coolant level
- The coolant reservoir with filler neck is arranged away from the radiator. To replenish coolant, the car must be on level ground.

Do not remove pressure cap on coolant reservoir if engine temperature is above 90° C/194° F. Allow engine to cool down before

removing cap. The coolant reservoir contains hot water and is under pressure.

First turn cap to first notch to relieve excess pressure using a rag. If opened immediately, hot scalding fluid and steam will be blown out under pressure.

Add cold water only if engine is running. Both hot and cold engines can be readily filled up with hot water (see also “fuels, coolants, lubricants, etc.”, page 75).

If a small amount of coolant has to be added (due to evaporation of water), plain water can be added.

If a larger quantity of coolant has to be added, a 50/50 mixture of water and antifreeze should be used.

The coolant level must reach:

- the mark indicated on the reservoir when the coolant is cold.
- approximately 2 cm/0.8 in higher when the coolant is hot.

The drain plugs are situated on the R-H and L-H engine side and on the radiator bottom.

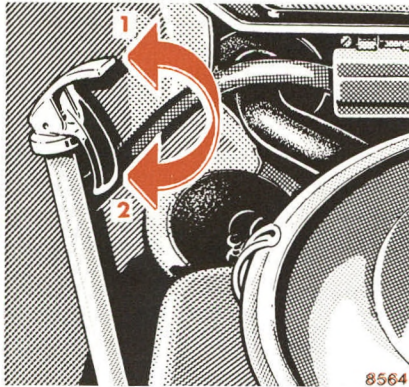

### Automatic Transmission Fluid Level

At regular intervals, check the fluid level of the automatic transmission together with the engine oil level prior to every long trip.

Check transmission fluid level with the engine idling, parking brake engaged and selector lever in position "P". The vehicle must be parked on level ground. Prior to the check, allow engine to idle for approx. 1 to 2 minutes.

Measure oil level with the dipstick completely inserted and the locking lever released (1).

Painstaking cleanliness must be observed! To wipe the dipstick, use a clean, lint-free cloth (preferably leather). To fill the transmission with fluid, only pour it through a fine-mesh filter into the dipstick opening. Even the slightest impurity may cause operational troubles.

The oil level in the transmission is dependent upon the oil temperature. The maximum and minimum oil level marks on the dipstick are applicable references only if the transmission fluid has reached its normal operating temperature of 80° C/176° F. – If, however, the transmission fluid cools down to 20–30° C/68–86° F, which is the normal shop temperature range, then the maximum oil level will be approximately 30 mm/1.2 in below the minimum mark on the dipstick. We stress this point because an oil change is normally performed when the transmission oil has cooled down to shop temperature.

The fluid level must not exceed the dipstick maximum mark with the fluid at operating temperature. Drain or siphon off excess fluid, if required.

Then push dipstick all the way in and swing locking lever downwards (2).



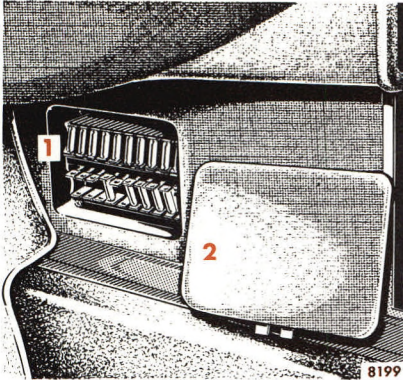

### Fuses

The fuse box (1) is accommodated in the R-H side floor space.

A table in the fuse box cover (2) depicts all the protected electrical units.

Fuses must not be repaired or bridged.

Spare fuses for emergencies (observe amperage and color) are stowed with the tools.

Diagnose the cause of a short circuit before replacing a burned-out fuse.

### Battery

The battery is located in the trunk.

Replenish with distilled water approximately every 4 weeks, and more often in summer and in hot zones.

Do not use metal funnels and do not perforate the diaphragm of the battery overflow protection.

The battery is filled to the maximum level when the water level in the cell filling chamber stops going down.

If battery acid is to be extracted for battery diagnosis purposes, perforate the diaphragm with the hydrometer or the tube attached to it.

Coat battery terminal clamps with acidproof grease. Keep battery clean and dry.

Only tow vehicle with the battery connected.

Only charge battery with the rapid charger when it is disconnected from the vehicle circuit.

Note:

While the engine is running the battery terminal clamps must not be loosened or detached as otherwise the alternator and other electronic units would be damaged.

### Spark Plugs

This vehicle is equipped with spark plugs as required for driving in the USA. Should additional information be necessary, your MERCEDES-BENZ dealer will be happy to offer advice.



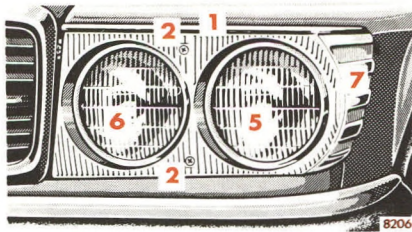

### Replacing Bulbs

To remove, push the bulb in and turn to the left, then lift the bulb out.

To install, grip the bulb with a paper tissue or similar cloth, align the pins on the base of the bulb with the grooves in the bulb socket, push in lightly and turn to the right until the stop is felt.

Install only bulbs of prescribed wattage. Refer to "Technical Data and last page".

### Headlamp Aiming

Correct headlamp aiming is of paramount importance to the road-worthiness of the car. Check and readjust headlamps at regular intervals and invariably when a lamp has been replaced.

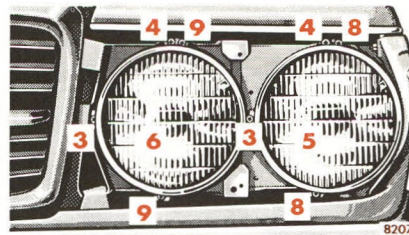

### Front Lamps

(Sealed Beam Version – USA Specifications)

- 1 Cover
  - 2 Securing screws for cover
  - 3 Horizontal aiming screws
  - 4 Vertical aiming screws
- Loosen securing screws 2 and detach cover 1.
- 5 High and low beam sealed-beam unit (type 2):  
Loosen clamping screws 8, remove retaining ring and unit, disconnect plug and socket on unit.

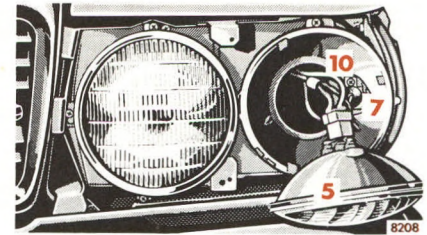

- 6 High beam sealed-beam unit (type 1):  
Loosen clamping screws 9, remove retaining ring and unit, disconnect plug and socket on unit.
- 7 Side marker lamp:  
Remove unit 5, loosen clamping screw 10 and detach lamp holder. Depress bulb, turn left and pull out.

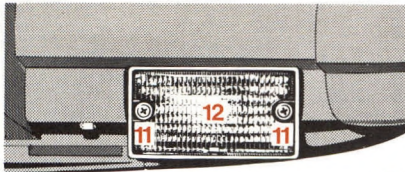

8458

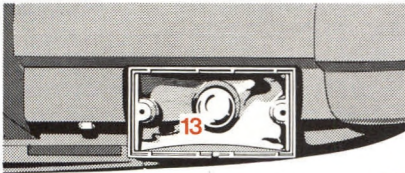

8459

- 13 Bulb for turn signal, clearance and standing lamps:

The lamps are located below the bumper.

Loosen securing screws 11 and remove lens 12.

Depress bulb 13, turn left and pull out. When replacing the lens, it must be ensured that the lug in the lens is at the bottom.

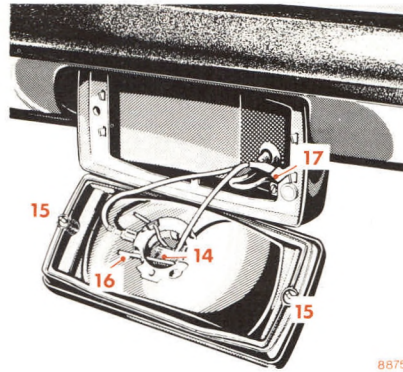

8875

- 14 Bulb for fog lamp:  
Loosen securing screws 15 and remove housing. Detach holding spring 16, remove bulb 14 and disconnect plug 17.

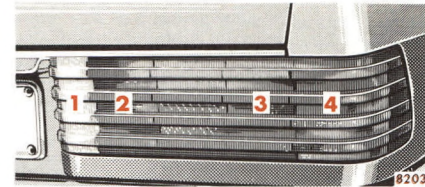

8203

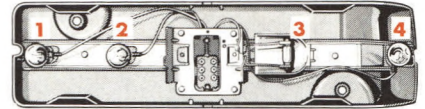

8204

### Tail Lamp Assembly

Remove both knurled nuts in the trunk and pull off lens assembly. To replace the bulbs, depress, turn left and pull out.

- 1 Backup lamp
- 2 Stop lamp
- 3 Tail, parking and standing lamp
- 4 Turn signal lamp (ball lamp) side marker lamp (festoon lamp)



## Electrical System

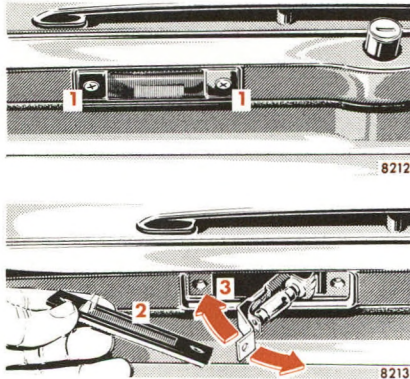

### License Plate Lamp

Loosen both the securing screws (1) of the lamp, detach lens with gasket (2) and pull down lamp holder (3) on the L-H side. When replacing the lens, it must be assured that the lug in the lens is on the L-H side.

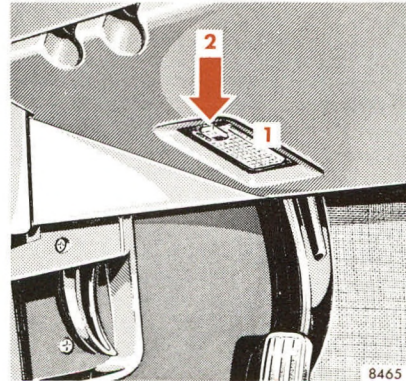

### Footwell Lamps

Press off lamp (1) at the nose (2), replace bulb and press lamp on again.

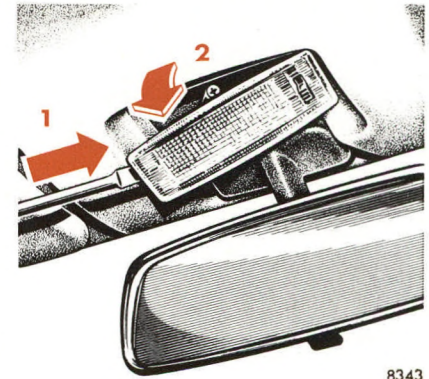

### Dome Lamps

450 SLC:

To replace the bulb, slightly press forward dome lamp to the right (1), lift up at left side (2) and then pull out to the left.

Remove rear dome lamp likewise.

450 SL:

To replace the bulb, pull out lamp.



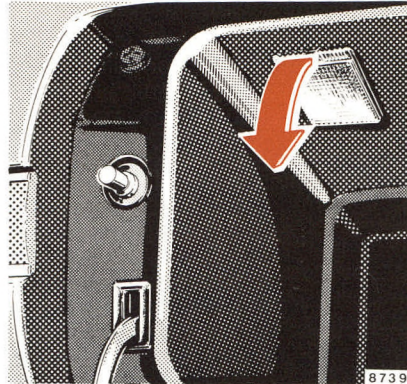

**Glove Compartment Lamp**

To replace the bulb, pull out lamp.

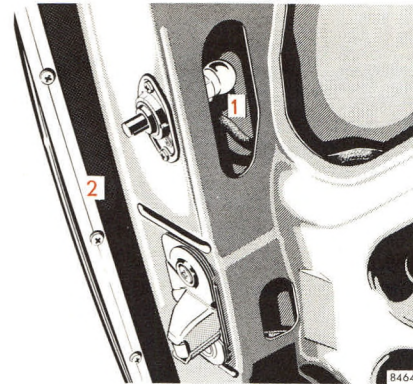

**Trunk Lamp**

The trunk lamp (1) is easily accessible when the trunk lid (2) is opened. To replace the bulb, depress, turn counterclockwise and take it out.

## Sliding Roof-Emergency Operation (450 SLC)

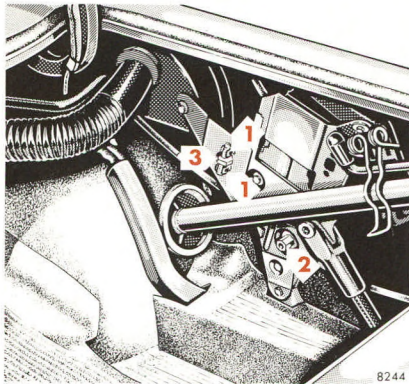

Should the electric drive become defective, the sliding roof can also be moved manually.

A manual drive (2) is provided on the drive motor (located in the trunk, R-H side) for this purpose. By means of the adapter (3) held in

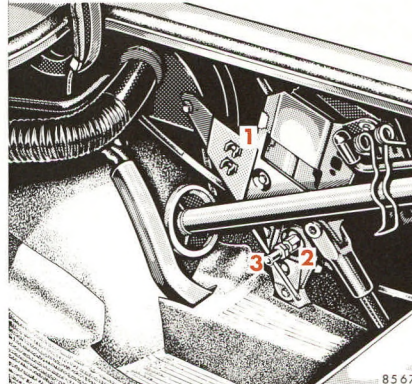

bracket (1) on the mounting plate and with a screwdriver the manual drive can be rotated and the sliding roof moved to the desired position. For this purpose, remove jack first.

To close the sliding roof, turn clockwise.

## Unlocking of the Filler Flap

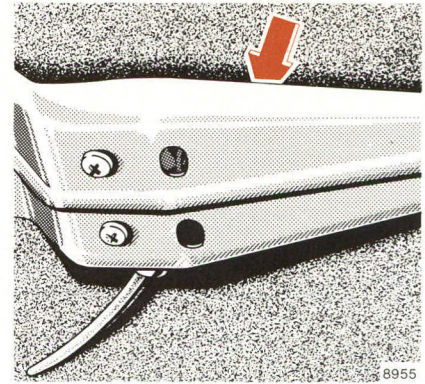

If the filler flap cannot be opened when the master lock system is unlocked, withdraw the link of the vacuum element (on RH side in trunk).

Towing eyes are situated underneath the R-H front and rear end. Use a solid towing link such as a towbar.

Only tow-start vehicle with the battery connected and the key in steering lock position "2".

**Caution:** As long as the engine is not running, the power assistance system is inoperative and substantially greater pedal forces need to be applied for braking; increased effort is also required to steer the car.

### **Emergency Engine Start (Tow-starting)**

The engine must be cold if it is to be started by towing or pushing the vehicle.

Never start a hot engine by towing or pushing the vehicle as the catalysts might otherwise suffer damage.

Move selector lever to position "N", switch on ignition and then tow-start the vehicle.

After reaching a speed of 30 km/h/ 18 mph, maintain this speed for about two minutes in order to ensure sufficient oil pressure in the transmission.

To start the engine, move selector lever to "L". Only touch the accelerator when the engine is revolving. As soon as the engine has fired, return the selector lever to "N" immediately.

If the engine fails to fire within a few seconds, return the selector lever from "L" to "N" as otherwise the transmission may be damaged.

For another starting attempt, tow car again for a short while with the selector lever in position "N" and then repeat starting procedure.

The same procedure may be used for starting the engine while rolling downhill.

### **Towing the Vehicle**

The vehicle may be towed with the driving wheels on the ground and the selector lever in position "N" for distances up to 120 km/ 75 miles and at a speed not to exceed 50 km/h/30 mph.

To positively avoid a possibility of damage to the transmission, however, we recommend to disconnect the drive shaft at the rear axle drive flange on any towing beyond a short tow to a nearby garage.



## Jump Starting

---

If the battery is discharged the engine can be started with jumper cables (minimum lead cross section is 35 mm<sup>2</sup>) and the (12 V) battery of another vehicle. Proceed as follows:

- Turn key to steering lock position "0".
- Run engine of jumper vehicle at high idle.
- First connect jumper cables to the positive battery terminals and then to the negative terminals.
- Start engine as normal.
- After the engine has started, first remove jumper cables from the negative battery terminals and then from the positive terminals.

### Instructions:

A discharged battery can freeze at approx.  $-10^{\circ}\text{C}/+14^{\circ}\text{F}$ . In all cases it must be thawed out before jumper leads are used.

Never lean over batteries while jump starting, you might get burned.

Technical Data  
Fuels Coolants  
Lubricants etc.



## Identification Plates

When ordering spare parts, please quote chassis and engine numbers.

The illustration depicts model 450 SL. On model 450 SLC identification plates are arranged accordingly.

- 6 Information Tag  
California version  
Vacuum line routing for  
emission control system
- 7 Emission Control Tag
- 8 Emission Control Tag  
Catalyst Information

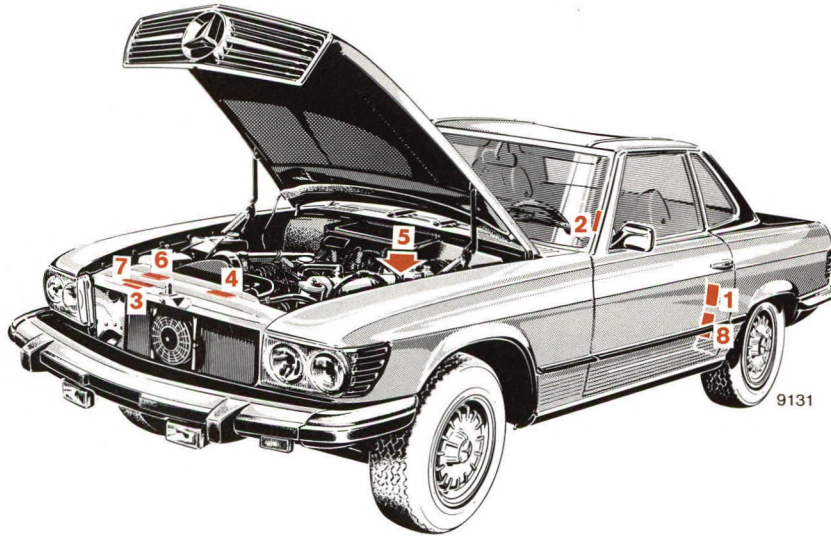

- 1 Certification Tag (left door pillar)
- 2 Identification Tag (left window post)
- 3 Chassis No.
- 4 Body No. and Paintwork No.
- 5 Engine No. on engine block, rear



The diagram shows a rectangular card divided into two main sections. The top section contains several columns of data, each represented by a series of horizontal bars of varying lengths, suggesting a barcode or a specific data encoding system. A large, bold number '1' is positioned in the top-left corner of this section. The bottom section of the card is a grid with approximately 10 columns and 15 rows, intended for handwritten or printed text. The number '9073' is printed at the bottom right of the card.

The vehicle data cards bear all the important data relating to your vehicle.

Data card No. 1 bears the key number and should on no account be left in the vehicle. Submit this card to your MERCEDES-BENZ service station to request a replacement key in case of loss.

Data card No. 2 bears no key data and is kept in the maintenance booklet. Presenting this card to the service station will facilitate the processing of the order.

## Technical Data

---

Type ..... 450 SL (107 044)  
Type ..... 450 SLC (107 024)

### Engine

Engine ..... 117  
Mode of operation ..... 4-stroke engine,  
gasoline injection  
No. of cylinders ..... 8  
Bore ..... 92 mm/3.62 in  
Stroke ..... 85 mm/3.35 in  
Total piston displacement ..... 4520 cm<sup>3</sup>/275.8 in<sup>3</sup>  
Compression ratio ..... 8  
Output according to SAE ..... 160 net bhp/4200 rpm  
Firing order ..... 1-5-4-8-6-3-7-2

### V-belts:

#### Water pump – fan – power steering pump

2 V-belts ..... 9.5 x 1170 mm  
Alternator ..... 9.5 x 1050 mm  
Air conditioning ..... 12.5 x 910 mm

### Transmission

Design ..... Automatic three-speed  
torque-converter transmission

### Steering System

Design ..... Power steering

### Electrical System

Alternator ..... 14 V/70 A  
Starter motor ..... 12 V/1.5 kW  
Battery ..... 12 V/88 Ah  
Spark plugs ..... see “last page”





**Fuels Coolants Lubricants etc. Capacities**

Vehicle components and their respective lubricants must match.

Therefore use only brands tested and recommended by us.

Enquire at your MERCEDES-BENZ service station.

	Capacity	Fuels, coolants, lubricants, etc.
Total oil capacity in case of engine oil and filter change	8.0 l/8.4 US qt	<p>Recommended engine oil</p> <p>Ambient temp. °C / °F</p> <p>SAE grades</p> <p>Year-round use multigrade oil</p> <p>8938</p>
Total oil capacity in case of engine oil change without filter replacement	7.5 l/7.9 US qt	
Automatic transmission	Initial fill: 8.9 l/9.4 US qt Fluid change: 7.9 l/8.3 US qt	Automatic transmission fluid (ATF)

**Fuels Coolants Lubricants etc. Capacities**

	Capacity	Fuels, coolants, lubricants, etc.
Rear axle	1.3 l/2.7 US pt	Hypoid gear oil SAE 90
Accelerator control linkage		Hydraulic fluid
Power steering	1.4 l/3.0 US pt	Automatic transmission fluid (ATF)
Front wheel hubs	approx. 70 g each/2.5 oz. each	Multipurpose or antifriction bearing grease
Grease nipples		Multipurpose or lubrication grease
Door locks		Special grease
Battery terminals		Bosch special grease
Brake reservoir	0.5 l/1.1 US pt	Brake fluid
Windshield washer system	approximately 5.0 l/5.3 US qt	Water plus windshield detergent
Fuel tank including a reserve of	approximately 90 l/23.8 US gal approximately 13 l/3.4 US gal	Unleaded gasoline: Average Octane of Research and Motor 87 (RON of 91)
Cooling system	15.0 l/15.8 US qt	Coolant

**Engine Oils**

Engine oils are specifically tested for their suitability in our engines. Therefore, use only engine oils recommended by us. Information on recommended brands is available at any MERCEDES-BENZ service station.

A new or reconditioned engine is filled with an initial operation oil

in the factory or in a MERCEDES-BENZ service station. This oil is specially developed for the specific operating conditions during the first 1300–1600 km/800–1000 miles.

A recommended engine oil may be used for topping up if the oil level drops to the dipstick minimum mark prior to the first service 1300–1600 km/800–1000 miles.

**Brake Fluid**

Brake fluid should be changed once a year, preferably in spring. Only use brake fluid recommended by us. For further information, refer to “Safe Driving”.



### Coolants

The coolant is a mixture of water and antifreeze. In production, the cooling system is filled with an anti-freeze-water mixture offering protection to approx.  $-30^{\circ}\text{C}/-22^{\circ}\text{F}$ . The red mark on the temperature gauge in the instrument cluster is matched to this antifreeze-water mixture (approx. boiling point  $125^{\circ}\text{C}/257^{\circ}\text{F}$ ). The protection against corrosion is also ensured by this mixture making it unnecessary to add a corrosion inhibitor.

The coolant remains in the cooling system all year round and must be renewed after 2 years at the latest.

If coolant has leaked from the cooling system, replace the missing quantity with water and a recommended brand of antifreeze.

For normal replenishment (due to evaporation of water) plain water will do.

The water should be clean, soft to medium soft and contain a minimum amount of scale forming minerals (potable water quality).

The coolant mixture should always contain enough antifreeze to ensure protection to a minimum of  $-20^{\circ}\text{C}/-4^{\circ}\text{F}$ .

If antifreeze is not available, add a corrosion inhibitor to the cooling water to ensure proper protection against corrosion. To treat the cooling water, do not use more than 1 % (10 cm<sup>3</sup>/l) of a recommended corrosion inhibitor.

Without antifreeze in the cooling system, the water already starts boiling at approx.  $118^{\circ}\text{C}/224^{\circ}\text{F}$ , which means that the pointer of the temperature gauge in the instrument cluster may still be below the red mark.

### Antifreeze

Your vehicle contains a number of aluminum parts. The use of aluminum components in motor vehicle engines necessitates that antifreeze/coolant used in such engines be specifically formulated to protect the aluminum parts. (Failure to use such antifreeze/coolant may result in a significantly shortened service life.)

While there may be a number of antifreeze/coolants available which will provide the requisite protection, all such products have not been tested for MERCEDES-BENZ vehicles. The following products, however, are deemed suitable for use in your car: MERCEDES-BENZ Anti-Freeze and Summer Coolant.

Protection up to	Antifreeze
$-20^{\circ}\text{C}$	5.25 l
$-4^{\circ}\text{F}$	5.6 US qt
$-30^{\circ}\text{C}$	6.75 l
$-22^{\circ}\text{F}$	7.1 US qt
$-40^{\circ}\text{C}$	7.75 l
$-40^{\circ}\text{F}$	8.2 US qt

## Service Literature

---

Customers who are interested in ordering service literature for their vehicles are advised to contact our subsidiaries in the U.S. or Canada at the following addresses, respectively

for U.S.A.: Mercedes-Benz of N.A. Inc.  
One Mercedes Drive  
P. O. Box 350  
Montvale, New Jersey 07645  
Att: Technical Publications  
Tel: (201) 573-0600

for Canada: Mercedes-Benz of Canada  
849 Eglinton Ave., East  
Toronto 17, Ont., Canada  
Att: Service Department  
Tel: 416-425-3550

The above companies will be happy to handle any such requests from customers.

We consider this to be the best way in obtaining accurate information for your vehicle.

### Printed in Germany

We reserve the right to modify the technical details of the vehicle as given in the data and illustrations of this Owner's Manual (s.e.e.o.). Reprinting, translation and copying, even of excerpts, is not permitted without our prior authorization in writing.

ZKD IX. 79. 6. R.

- **Fuel:** Unleaded gasoline: Average Octane of Research and Motor 87 (RON of 91). Fuel tank capacity approx. 90 l/23.8 US gal, this includes a 13 l/3.4 US gal reserve.
- **Engine Oil:** Year-round multigrade oils 10 W-40/10 W-50/15 W-40/15 W-50. For further information, refer to page 72.  
  
Quantity differential between upper and lower dipstick marking level: 2.0 l/2.1 US qt.
- **Automatic Transmission:** Automatic transmission fluid (ATF). For level checks and replenishment, refer to page 58.
- **Coolant:** For normal replenishment, use water (potable water quality). For further information (e. g. antifreeze), refer to page 75.
- **Bulbs:** High and low beams: Sealed beam insert No. 1 and 2, turn signal, clearance and standing lamps, front 21/5 W/32/3 cp, turn signal lamps, rear 21 W/32 cp, tail and standing lamps, rear 10 W festoon lamp, stop lamps 21 W/32 cp. For further information, refer to "Technical Data".
- **Spark Plugs:** Bosch W 9 D, Beru 14-9 D, Champion N 12 Y.
- **Tire Pressure:** Cold tires:

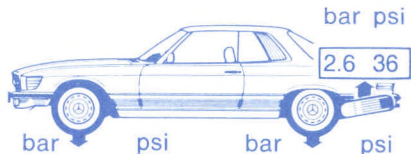

Warm tires:  
+ 0.3 bar/+ 4 psi

Summer tires:
Winter tires:

2.2 <sup>1</sup>	32 <sup>1</sup>
2.2	32

2.5 <sup>1</sup>	36 <sup>1</sup>
2.5	36

<sup>1</sup> For driving up to 175 km/h/110 mph  
-0.2 bar/-4 psi





Mercedes-Benz  
**service**

Daimler-Benz AG Stuttgart-Untertuerkheim Zentralkundendienst  
107 584 77 96 6500 5120 USA-Ausgabe H 1980

