

Owner's
Manual

380 SL

Mercedes-Benz

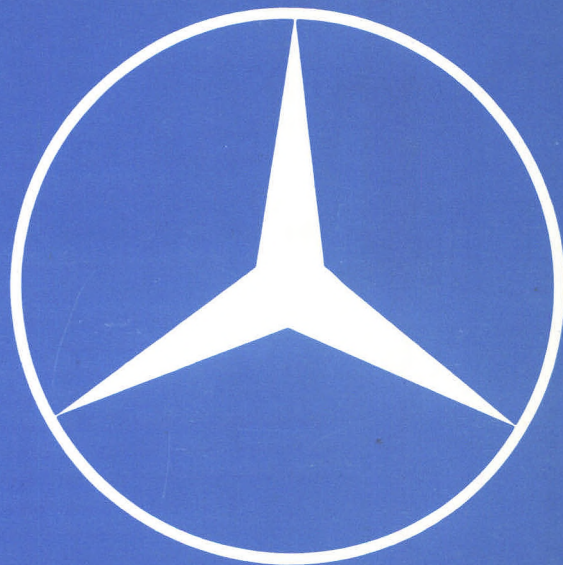

1982

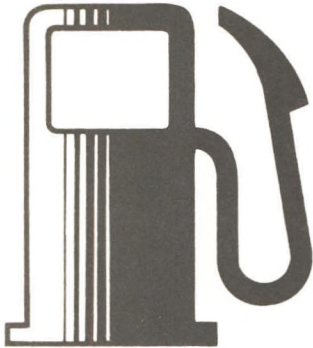

24

Drive Sensibly – Save Fuel

Fuel consumption depends to a great extent on driving habits and operating conditions.

In order to save fuel you should:

- ensure that tire pressures are correct
- not carry unnecessary loads
- remove ski racks or roof-mounted luggage racks when not in use
- not warm up your engine at idle and with the vehicle at standstill
- avoid frequent acceleration and deceleration
- avoid frequent braking
- avoid unnecessarily high speeds
- have all the maintenance jobs specified by us carried out at regular intervals by a MERCEDES-BENZ service station.

Driving in low temperature weather, in stop-and-go city traffic and on short hops, and in hilly country also increases fuel consumption.

380 SL

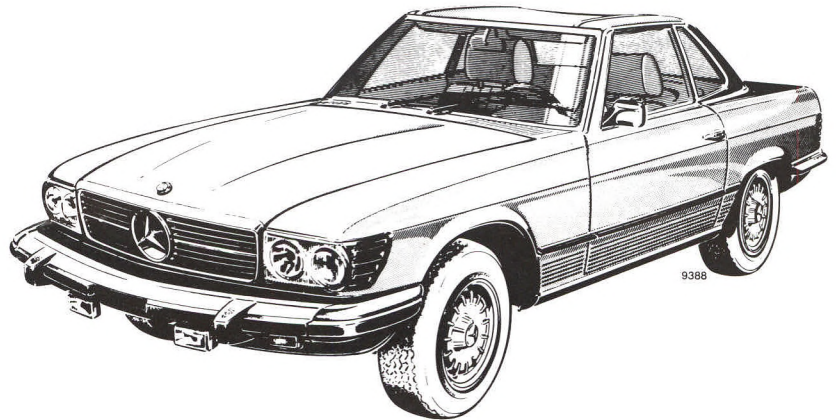

9388

Type 107
1982



You have chosen to drive a MERCEDES-BENZ, a car in whose construction and production we have taken great pains because we believe that quality is not a matter of chance.

Perhaps you have already had experience with a MERCEDES, maybe this is your first car from the DAIMLER-BENZ company. In both cases – for your own benefit – please read this owner's manual before putting it away. Even though you have been driving a car for years, some things in this car may be new to you, and this manual certainly contains a few hints which will help you to make the most of your new car.

We wish you safe and pleasant motoring.
DAIMLER-BENZ Aktiengesellschaft

Contents

This Owner's Manual also describes optional extras as far as an introduction on their handling is required. As these extras need to be ordered separately, the equipment of your vehicle may deviate from the descriptions and illustrations to some extent.

The last page

What you should know at the gas station

Vehicle Operation

Instruments and Controls	8
Instrument Cluster	10
Keys, Doors	12
Flat Key, Master Key and Supplementary Key	12
Obtaining Replacement Keys ..	12
Opening, Locking and Unlocking of Doors	12
Master Lock System	13
Seats	14
Adjustment of Driver's Seat and Front Passenger Seat	14
Safety Headrest	15
Seat Heater	15
Seat Belts	16
Controls	17
Steering Lock	17
Lighting Switch	18
Combination Switch	19
Cruise Control	20
Automatic Climate Control	21
Various Equipment	26
Rear View Mirrors	26
Sun Visors	26
Interior Lamps	26
Lighter	27
Heated Rear Window	27
Shelf below Rear Window	27
Roadster Top	28

Hardtop	29
Radio	31

Driving

Hood	38
Parking Brake	38
Regular Inspections	39
Catalytic Converter Cautions ...	40
Starting and Turning off the Engine	41
Starting and Shifting Gears	42
Safe Driving	44
Brake Pad Wear Indicator Lamp	45
Brake Fluid	45
Charge Indicator Lamp	45
Oil Pressure Gauge	46
Coolant Temperature Gauge ..	46
Emission Control	46
Engine Oil Consumption	46
The First 1500 km/1000 Miles ...	47
Driving Economically	47
Gauge for Economical Driving (ECONOMY)	47
Special Operating Conditions ...	47
Winter Driving	47
Hints for Driving	48
Tire Chains	48
Traveling Abroad	48

Vehicle Care

MERCEDES-BENZ Maintenance System 50
 Severe Operating Conditions 50
 Engine Oil Change and Filter Change 51
 Automatic Transmission-Fluid and Filter Change 51
 Spare Parts Service 51
 Cleaning and Care of the Vehicle Jobs related to Care 53

Practical Hints

Ash tray 56
 Luggage or Ski Racks 56
 Spare Wheel, Jack, Vehicle Tool Kit 56
 Wheels, Tires, Changing Wheels 57
 Wheels, Tires 57
 Changing Wheels 58
 Tire Inflation Pressure 58
 Checking Fuels, Coolants, Lubricants, etc. 59
 Engine Oil Level Check 59
 Checking Coolant Level 60
 Automatic Transmission Fluid Level 61

Electrical System 62
 Replacing Bulbs 62
 Fuses 66
 Battery 66
 Spark Plugs 66
 Emergency-starting and Towing the Vehicle 67
 Jump Starting 68
 Unlocking of the Filler Flap 68

Technical Data – Fuels, Coolants, Lubricants, etc.

Identification Plates 70
 Vehicle Data Cards 71
 Warranty Coverage 71
 Technical Data 72
 Fuels, Coolants, Lubricants, etc. 74
 Capacities 74
 Engine Oils 76
 Brake Fluid 76
 Coolants 77
 Service Literature 78

Vehicle Operation



Driving



Vehicle Care



Practical Hints



Technical Data – Fuels, Coolants, Lubricants, etc.



Vehicle Operation



Instruments and Controls

For more detailed descriptions see quoted pages.

- 1 Swivelling side ventilation outlets (page 21)
- 2 Control lever for side ventilation (page 21)
- 3 Parking brake release button (page 38)
- 4 Hood release lever (page 38)
- 5 Parking brake pedal (page 38)
- 6 Combination switch (page 19)
- 7 Lighting switch (page 18)
- 8 Instruction tag (except tourist vehicle).
Use only unleaded gasoline
- 9 Cruise control (page 20)
- 10 Instrument cluster (page 10)
- 11 Horn control
- 12 Steering lock with ignition/starter
switch (page 17)
- 13 Swivelling outlets for nonheated fresh air (page 21)
- 14 Switch for front dome lamps
- 15 Switch for automatic antenna (page 36)
- 16 Switch for heated rear window (page 27)
- 17 Radio (page 31)
- 18 Automatic climate control (page 21)
- 19 Ash tray with lighter (page 27, 56)
- 20 Switch for left window lifter
The electric window lifter can only be operated
with the steering lock in position "2".
- 21 Switch for left seat heater (page 15)
- 22 Switch for hazard warning flasher system
- 23 Switch for right seat heater (page 15)
- 24 Switch for right window lifter
The electric window lifter can only be operated
with the steering lock in position "2".
- 25 Glove compartment (to open, shift handle
sideways). Only illuminated if steering lock is
in position "1" or "2".
- 26 Loudspeaker cover, right and left

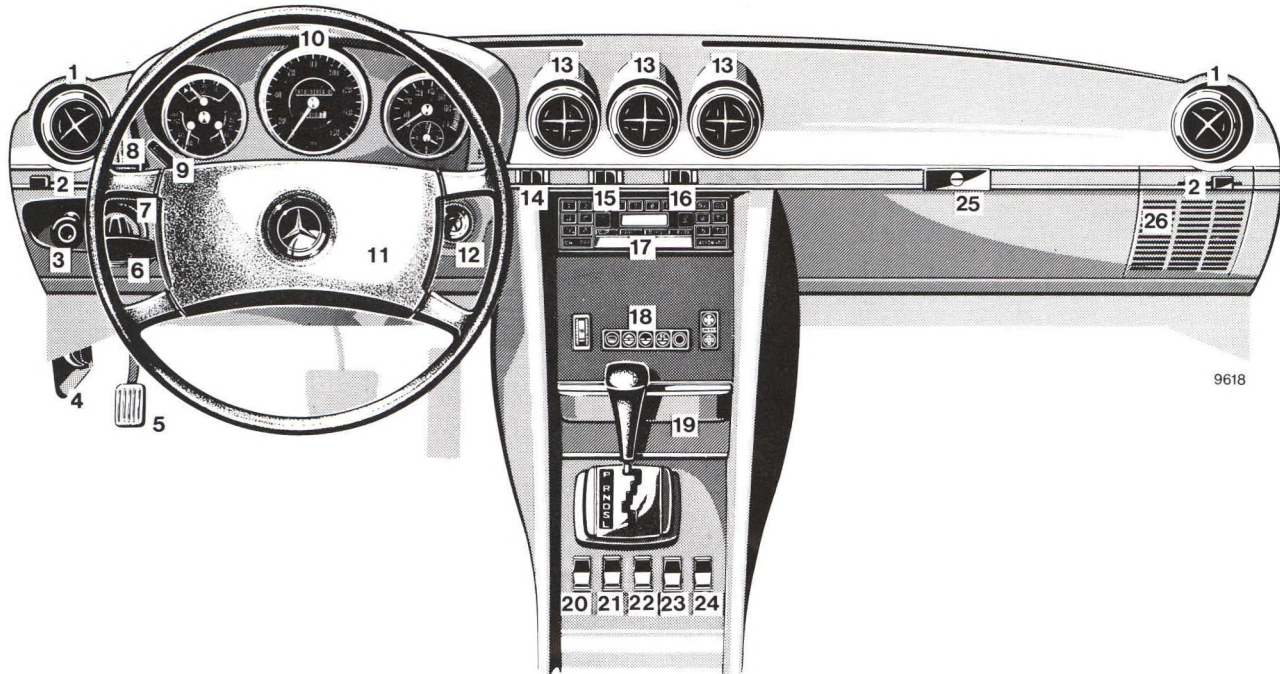

Instrument Cluster

- 1 Gauge for economical driving (ECONOMY).
See page 47
- 2 Coolant temperature gauge (° C)
Up to red marking: Maximum permissible temperature for an antifreeze-blended fill protecting down to -30° C/-22° F. See page 46
- 3 Fuel gauge with reserve warning lamp (yellow)
Fuel reserve and capacity, refer to page 75 and last page
- 4 Oil pressure gauge (bar). See page 46
- 5 Main odometer
- 6 Trip odometer
- 7 Knob for clock adjustment
(press in for adjustments)
- 8 Electric clock
- 9 Tachometer
- 10 Red marking on tachometer:
Excessive engine revolutions
- 11 Turn signal indicator lamp, right (green)
- 12 O₂-Sensor replacement indicator lamp (red):
When the indicator lamp comes on, the O₂-Sensor must be replaced
- 13 Seat belt warning lamp (red)
- 14 Brake pad wear indicator lamp (yellow):
Lights up during braking if the front wheel brake pads are worn down. See page 45
- 15 Dimmer knob for instrument lamps,
continuous adjustment
- 16 Resetting knob for trip odometer
(push button)
- 17 Brake warning lamp (red) comes on if
 - the parking brake is engaged
 - too little brake fluid is in the reservoir
- 18 High beam indicator lamp (blue)
- 19 Charge indicator lamp (red):
Comes on when the steering lock key is moved to driving position "2" and must go out when the engine is idling. See page 45
- 20 Turn signal indicator lamp, left (green)

Note

A stop is provided on the speedometer at the 138 km/h/85 mph reading. Speeds in excess of 138 km/h/85 mph will no longer be recorded.

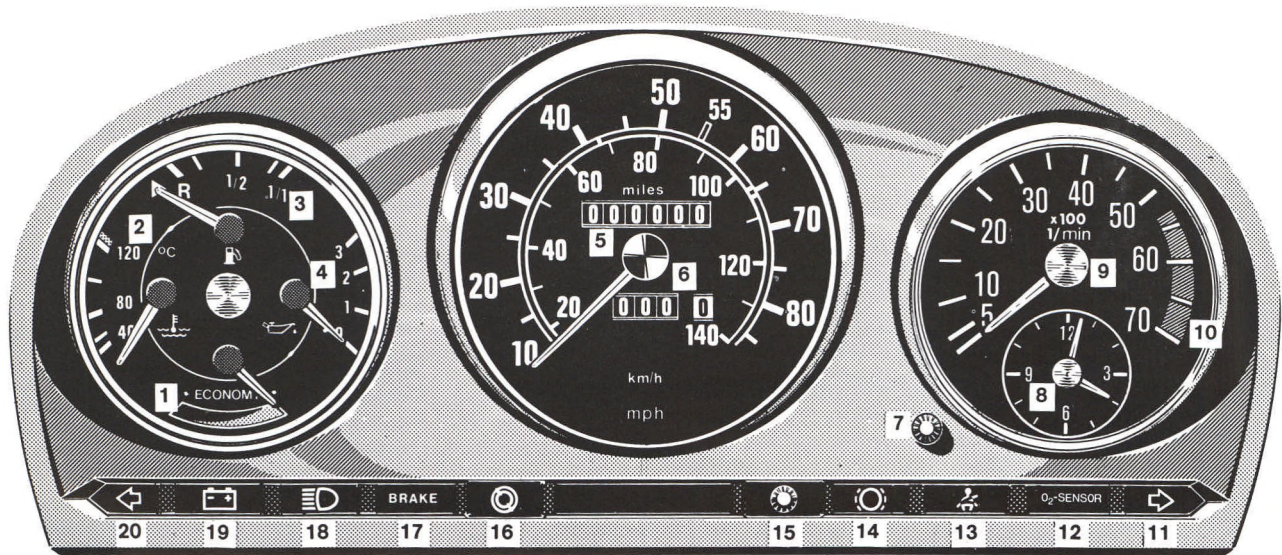

9549

Keys - Doors

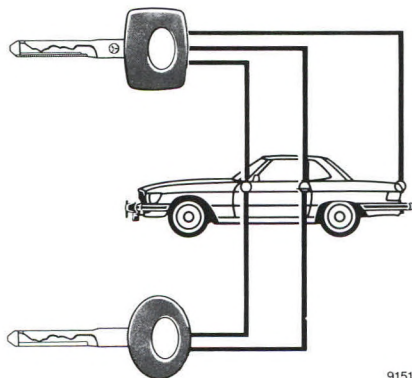

9151



Flat Key

The flat key fits all vehicle locks. We recommend that you carry the flat key with you and keep it in a safe place so that it is always handy, if needed (e.g. in your wallet). Never leave the flat key in the vehicle.

Master Key – square headed – fits all locks on the car.

Supplementary Key – rounded head – fits only the door locks and the steering lock. This key is intended to be used whenever the car is

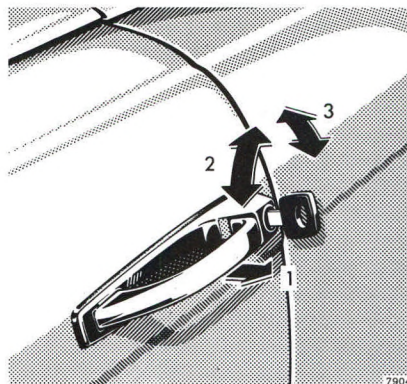

7904

left with an attendant. Be sure to lock glove compartment and trunk with the master key.

Obtaining Replacement Keys

You are handed over 4 keys together with your vehicle. Replacement keys can be obtained only via MERCEDES-BENZ service stations. If the keys are lost, assistance is rather time consuming and expensive.

Opening the Doors

From outside: pull handle outwards (1).

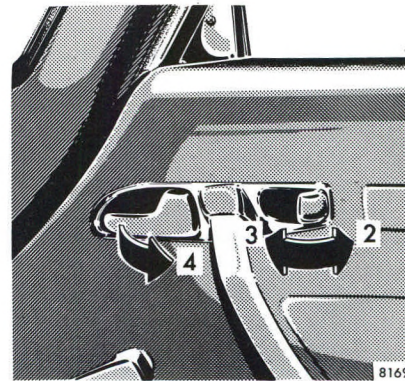

8169

From inside: pull handle in door panel (4).

Locking and Unlocking of Doors

From the outside: turn key.
From the inside: actuate safety catch.

- 2 Unlocking
- 3 Locking

One cannot lock:

- the driver's door if it is open.
- any door if the door lock has not engaged fully. In this case open the door and shut it again.

Master Lock System

The master lock system enables the front passenger door, the fuel tank filler flap and the trunk lid to be locked or unlocked together with the driver's door. When locking or unlocking, the locking levers on both doors must move simultaneously. If one locking lever fails to do so, the lock of that particular door is not properly engaged. The door must then be opened and closed correctly.

With the master lock system in the locked position, the front passenger door can be locked and unlocked either with the locking lever or with the key.

Actuation of the locking lever on the front passenger door, however, is not possible when the master lock system is in the unlocked position.

The trunk lid can also be unlocked separately by turning the master key counterclockwise to the stop. Push

the trunk lock button in with it and lift the lid. Return the key to its initial position and withdraw it. To lock the lid, close it firmly. It will then be locked again by the master lock system.

A provision has been made to facilitate permanent locking of the trunk lid for positive prevention of access to trunk by unauthorized persons.

Before leaving vehicle with an attendant, lock trunk with master key (square head) by turning key clockwise to stop (tumbler slot vertical), then provide attendant with round-headed supplementary key. Thus, the trunk lock has been excluded from the operation of the master lock system and cannot be opened except with the square-headed master key.

To reverse this, turn trunk lock counterclockwise back to horizontal position of the tumbler slot with master key. Lock will then be reengaged in master lock system; that is, it will automatically be locked or unlocked depending on whether the driver's door is locked or unlocked.

The master lock system operates on vacuum generated by the engine. A reservoir allows the master lock system to be actuated about five times after the engine is turned off. If the system can then no longer be engaged, idle engine for a short period.

If no vacuum is available, doors and trunk have to be locked individually in the normal manner. The fuel tank filler flap, however, remains unlocked.

Note:

If the filler flap cannot be opened when the master lock system is unlocked, refer to "Unlocking of the Filler Flap" (page 68).

Seats



Adjustment of Driver's Seat and Front Passenger Seat

Forward/backward adjustment: lift handle (1), push seat backward or forward and allow handle to reengage.

Seat elevation (6 positions): Each time handle (2) is pulled up, the seat is raised by one notch. If the handle is pushed down completely, the seat will return to its lowest position. Afterwards, pull handle once to engage the seat in its first position.

Back rest tilt: turn handwheel (3) back or forth.

For full reclining of backrest, seat should be moved to one of the forwardmost positions and headrest removed. For driving, return backrest to upright position and push seat back. Replace headrest.

After disengaging the stop by lifting knob (4), the back rest can be folded forwards.

Note:

Prior to operating the vehicle, the driver should adjust the seat height for proper vision as well as fore-aft placement and seat back angle to insure adequate control, reach, operation, and comfort. The headrest should also be adjusted for proper height so that when the cushion is tipped completely forward, it should form a cradle behind the seat occupant's head. Both the inside and outside rear view mirrors should then be adjusted for adequate rearward vision. Fasten seat belts.

All seat, headrest, and rear view mirror adjustments as well as fastening of seat belts should be accomplished before the vehicle is put into motion.

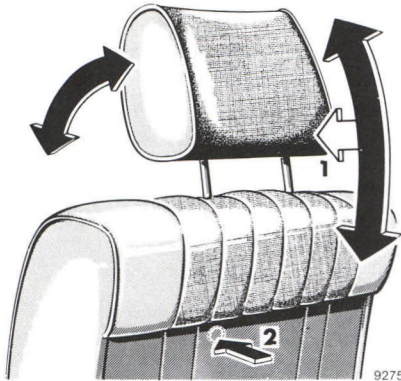

9275

Safety Headrest

Adjust headrest to support the back of the head approximately at ear level.

Height adjustment:

Press headrest slightly forward (1) and reset upward or downward.

Detaching headrests:

Pull headrest out to the stop. Release arrester by depressing release knob to be felt under the covering

material in rear of back rest and pull up headrest quickly, holding it by the LH headrest post (viewed in driving direction). Finally pull out headrest completely with both hands.

The headrest locking knob of the front seat is located below the LH headrest post (2).

Seat Heater

The seat heater can be switched on when the steering lock is in position "1" or "2".

Push switch to position 1 = continuous operation. The indicator lamp in the switch comes on.

Push switch to position 2 = rapid heating. Both indicator lamps in the switch come on.

Switch in center position = seat heater off.

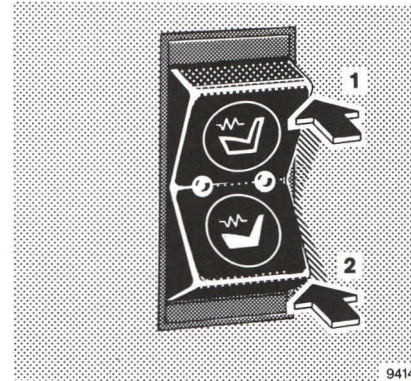

9414

Due to the relatively high power consumption of the seat heater a heavy load is placed on the battery. For this reason the switch should not be left in position 2 any longer than is absolutely necessary while the engine is switched off.

Seats

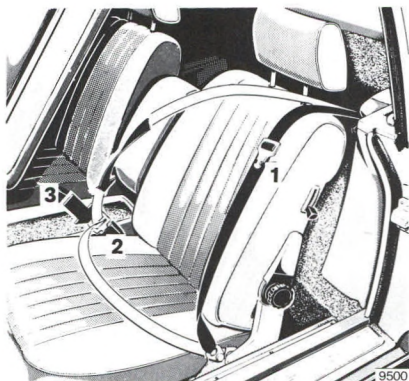

Seat Belts

Warning System:

The indicator is illuminated for 4–8 seconds after turning the steering lock key to position “2”. If the seat belt of the driver’s seat is not fastened a warning buzzer sounds simultaneously.

Fastening:

- Pull belt with latch plate (1) over shoulder and lap. The belt must not be twisted.
- Press latch plate (1) into buckle (2) and allow to engage audibly.
- The belt must be tight and must be checked for tightness immediately after fastening and regularly during the trip. If required, tighten lap belt by pulling up on the upper belt section.

Unfastening:

- Depress red button (3) in buckle.
- Return latch plate (1) to initial position.

Operation:

The seat belt inertia reel stops the belt from unwinding further in case of vehicle deceleration in any direction or if the belt is pulled out quickly.

Functional test:

The locking function of the inertia reel can be tested by braking, driving around a bend or by pulling the belt out quickly.

Note:

No seat belt can be used for more than one person. Belts are not intended for children.

After an accident, inspect the seat belts and replace them, if required. The belt anchors in the vehicle should also be checked.

Renew damaged belt webbing.

Belt webbing must not be routed via sharp edges.

No modifications which may affect the efficiency of the belts must be made.

For cleaning and care of belt webbing, refer to page 53.

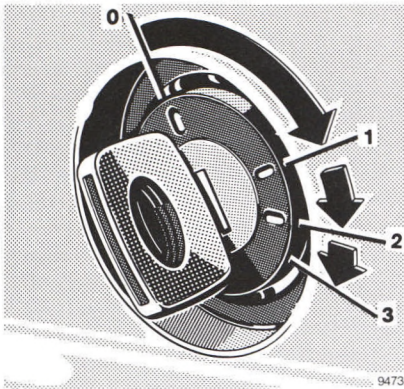

Steering Lock

- 0 Steering is locked when the key is withdrawn and the steering lock is engaged. The key can be withdrawn only in zero position.

Note:

Do not remove key from steering lock while the vehicle is in motion as this will cause the engagement of the steering lock thus rendering the vehicle inoperable.

- 1 Steering is unlocked. (If necessary, move steering wheel slightly to turn the key clockwise to position "1".)
- 2 Driving position.
- 3 Starting position.

For starting and turning off the engine, refer to page 41.

Notes:

The following items can be operated with the key in steering lock position "1".

Wiper, windshield washer, head-lamp flasher, lighter, glove compartment lamp, radio, electric seat heater.

The power supply to the standing lamps is disrupted if the key in the steering lock is in position "2".

A warning buzzer sounds when the key has been left in steering lock positions "1" or "0" and the driver's door is opened.

With the engine at idle speed, the charging rate of the alternator (output) is limited.

It is therefore recommended to turn off unnecessary electrical consumers while driving in stop and go traffic. This precaution helps to avoid draining of the battery.

An effective measure to preserve battery power is to turn off the following consumers:

Seat heater, heated rear window and fog lamps.

Controls

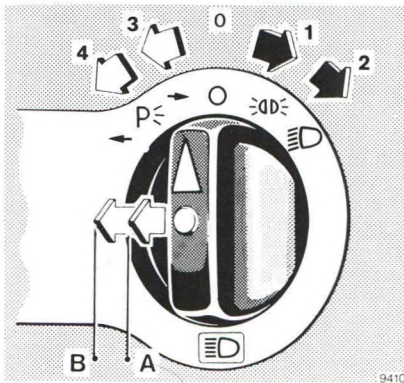

Lighting Switch

- 0 Off-position
- 1 Parking lamps (includes side marker lamps, tail lamps, license plate lamps, instrument panel lamps)
- 2 Same as pos. 1 plus headlamps
- 3 Standing lamps, right
- 4 Standing lamps, left
- A Turn to position 2 and pull out to first detent = same as position 2 plus fog lamps
- B Available for an option

Note:

With the steering lock key removed and the driver's door or the front passenger's door open a signal sounds if the vehicle's exterior lamps are not switched off (standing lamps excepted).

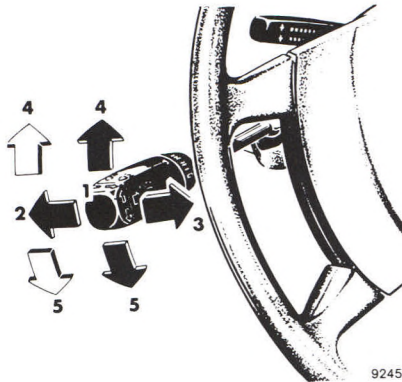

Combination Switch

- 1 Low beam (lighting switch turned clockwise to 2nd notch)
- 2 High beam (lighting switch turned clockwise to 2nd notch)
- 3 Headlamp flasher (high beam available independent of lighting switch position)
- 4 Turn signals, right
- 5 Turn signals, left

To operate the turn signals, move the combination switch past the point of resistance (up or down). The switch is automatically cancelled when the steering wheel is turned by a large enough angle.

To signal minor directional changes of the vehicle, such as changing lanes on a highway, move combination switch to the point of resistance only and hold it there.

- 6 Control for windshield washer system
When the washer system is switched on, the wipers also operate.
- 7 Windshield wiper control
 - 0 Windshield wiper switched off
 - I Intermittent wiping
 - II Normal wiper speed
 - III High wiper speed

Hints:

If one of the turn signals fails, the turn signal indicator system flashes and sounds at a faster sequence than under normal operating conditions.

Fog lamps will only operate together with low beam headlamps. Fog lamps are turned off automatically when lighting switch is returned to off-position.

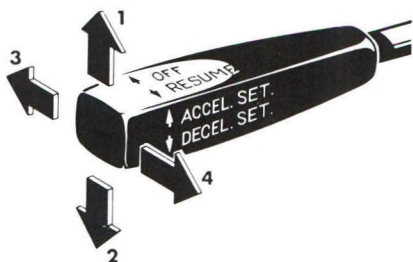

Cruise Control

Any given speed above approximately 40 km/h/25 mph can be maintained with the cruise control by operating the switch.

- 1=Setting (touch switch)
Accelerating (hold switch)
- 2=Setting (touch switch)
Decelerating (hold switch)

Normally the vehicle is accelerated to the desired speed with the accelerator. Speed is set by

briefly pushing the switch to position "1" or "2", and the accelerator can be released. The speed can be increased (e. g. for passing) by using the accelerator. As soon as the accelerator is released, the previously set speed will be resumed automatically.

If a set speed is to be increased or decreased slightly, e.g. to adapt to the traffic flow, retain switch in position "1" or "2" until the desired speed is reached. When the switch is released, the newly set speed remains.

- 3= Cancelling
To cancel the cruise control, briefly push lever to position "3".
The cruise control will also be cancelled if the brake pedal is actuated or if the vehicle speed drops below 40 km/h/25 mph.

- 4=Resume

If the lever is briefly pushed to position "4" when driving at a speed exceeding approximately 40 km/h/25 mph, that speed is resumed which was set prior to the cancellation of the cruise control.

The last memorized speed is cancelled when the key in the steering lock is turned to position "1" or "0".

Important:

Only use the cruise control if the traffic conditions make it advisable to travel at a steady speed.

Position "Resume" should be engaged only if the driver is fully aware of the previously set speed and wishes to resume this particular preset speed.

When driving with the cruise control, the selector lever must not be shifted to position "N" as otherwise the engine will overrev.

Automatic Climate Control

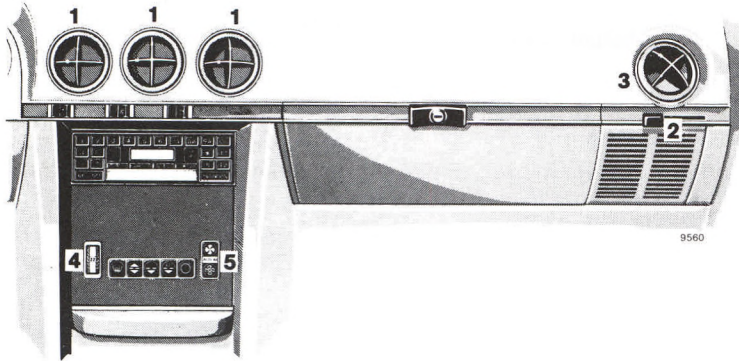

Optimum functioning of the automatic climate control system can only be expected with the windows closed, the roadster top up or with the hardtop in place.

The proper use of the automatic climate control system will add considerably to your comfort (well-being).



The ACC unit will work only with the engine running.

Heating, cooling and air distribution within the vehicle's interior (tri-level) is automatically controlled.

Furthermore, settings are available for extreme weather conditions, enabling the defogging of the windshield or air ventilation to top and bottom. This is accomplished with the temperature selector (4), the push buttons, and the blower switch (5).

The movable nozzles (3) can be adjusted with levers (2).
Levers (2) to center of car = open

All push buttons and blower control buttons should only be operated individually. The indicator lamps in the individual buttons light up when pressed with the lighting switch in position 1 or 2.

We strongly recommend settings  and  only, in connection with the desired blower setting. The following instructions explain the remainder of settings for special purposes.

Automatic Climate Control

Temperature Selection (°C)



The interior temperature can be adjusted infinitely by turning the temperature selector wheel. The selected temperature is reached as quickly as possible and maintained. A basic setting of 22 °C/72 °F is recommended. In order to avoid undesirable temperature fluctuations, a set temperature should be readjusted in small increments only:

To override the automatic climate control, turn the temperature selector wheel to either end position notches “Max” or “Min”.

“Min” (notched-in) = peak cooling performance, whereby the system operates mostly with recirculated air and a small amount of fresh air is added. If the blower control is set to “AUTOM”, it will run continuously in speed No. 5.

“Max” (notched-in) = Maximum heating performance. If the blower control is set to “AUTOM”, it will run continuously in speed No. 5.

Blower Setting

 Selection for blower settings can be made as follows:

 Push upper button for maximum air supply (6th blower speed).

Push lower button for minimum air supply (1st blower speed).

Push middle button (spring loaded) for automatic control of air supply within 2nd through 5th blower speed range.



Setting  = Always maximum air supply.

Functions

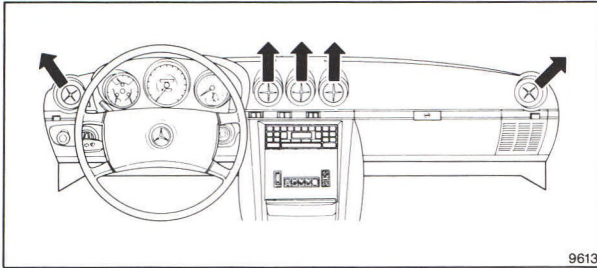

 Off

In this setting, the air supply to the interior of the car is shut off, (in case of bad odor or automatic car wash). Use this setting only temporarily while driving.

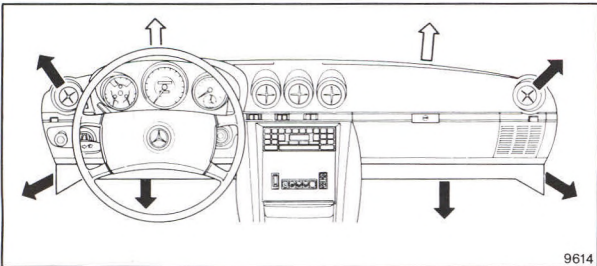

-  Economic setting – Ventilation
-  Normal setting – Cooling



-  Economic setting – Heating
-  Normal setting – Heating

 EC (ECONOMY) = Economical setting; the air conditioning compressor stays off.

In any other settings, the air conditioning compressor comes on with ambient temperatures above +2° C/ 36° F.

We recommend this setting to be used with cool outside temperatures so that the air conditioning compressor stays off in order to save fuel.

In the ventilation mode, air will only be channeled to the movable inserts (1) and (3).

In the heating mode, warm air will mainly be channeled into the leg room. In addition, air will be channeled to the movable nozzles (3) and the doors. Only an amount of air sufficient to prevent fog build-up under normal climatic conditions will be channeled to the windshield. In the heating mode, air will occasionally be channeled to the nozzles (1).

With cold outside temperatures, the fresh air supply and the blower remain turned off until the engine coolant has warmed up slightly.

 Normal Setting

We recommend this setting with humid and warm outside temperatures.

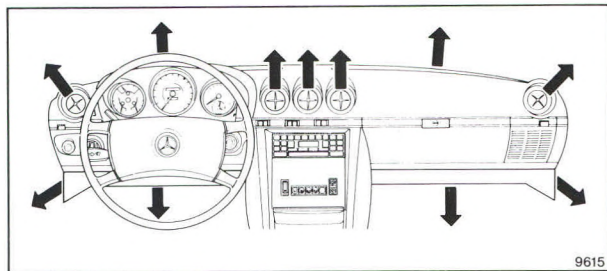

Automatic Climate Control



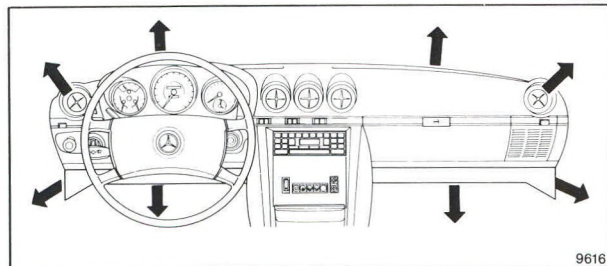

 Bi-Level ventilation – Cooling



 Bi-Level ventilation – Heating

The setting  corresponds with setting  but, in addition, the air is being cooled or preheated as necessary.

Bi-Level

This setting is necessary for clearing a fogged windshield. As soon as possible, reset to  or .

In the heating mode, air will be channeled to the windshield, the leg room, the movable nozzles (3) and to the doors; in the cooling mode, additionally to the movable nozzles (1). In the heating mode, air will occasionally be channeled to the nozzles (1).

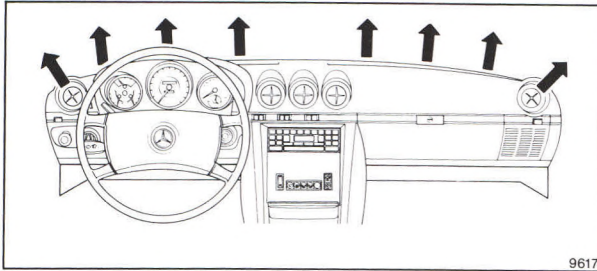



 Defrosting

Defrosting

Independent of the position of the temperature selector wheel and the blower speed setting, optimally heated air will be channeled to the windshield and the movable nozzles (3).

Important!

To ensure proper operation of the automatic climate control system, engage buttons  or  at least once a month for a short period when the outside temperature is above +2°C/36°F.

Various Equipment

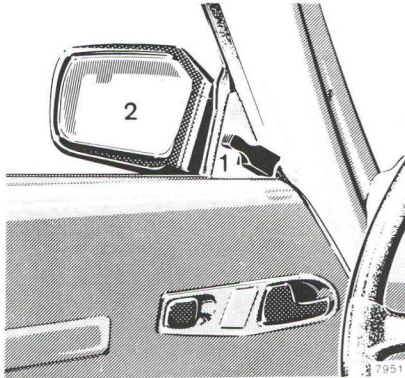

Rear View Mirrors

Outside rear view mirror:
Outside rear view mirror (2) can be randomly adjusted by means of lever (1).

Inside rear view mirror:
Mirror housing can be randomly adjusted. In addition mirror can be dimmed by means of lever on lower mirror edge. Lever in opposite driving direction = normal position.
Lever in driving direction = anti-glare position.

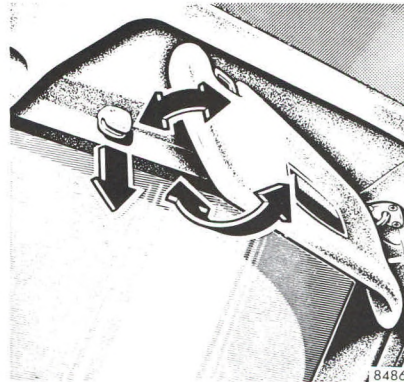

Sun Visors

Swing sun visors down to protect against sun glare.

If sunlight enters through the side window, disengage visor from inner mounting and swing to the side.

Interior Lamps

The footwell lamps below the instrument panel are switched on as long as one of the doors is open.

The front dome lamps are switched on and off by means of a rocker switch on the instrument panel.

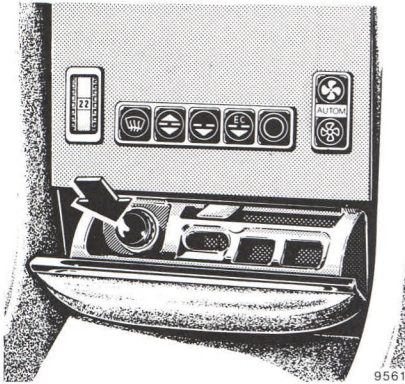

Lighter

Turn key in steering lock to position "1" or "2".

Push the lighter in to heat it. It will pop out as soon as the filament glows.

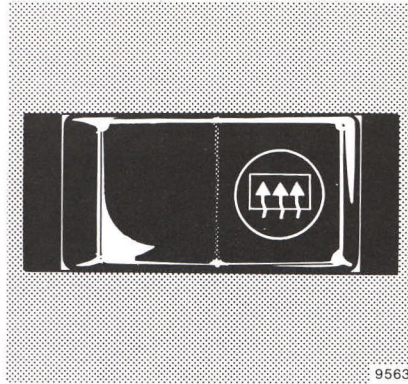

Heated Rear Window

Turn key in steering lock to position "2".

When the rear window heater is turned on, the white indicator lamp in the switch comes on.

A heavy load is imposed on the battery due to the high power requirement. For this reason, switch off the heated rear window as soon as it is demisted or defrosted. It is shut off automatically after a maximum of 30 minutes. Always remove heavy layers of ice and snow first.

Shelf below Rear Window

Do not carry heavy or hard objects on the shelf below the rear window. Such items could become dislodged during hard braking or upon a vehicle crash causing distraction or serious injury to the vehicle occupants.

Roadster Top

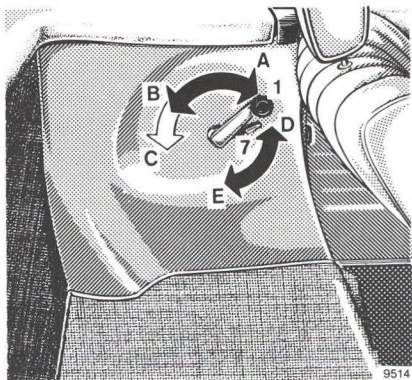

If possible, park vehicle in the shade as continuous exposure to sun rays will harm canvas color and rubber coating.

To lower or raise the folding top or to remove or attach the hardtop, find two locking handles in a bag stowed in the glove compartment. They are used to engage or disengage locks (4). Put locking handles back into the glove compartment after use.

Lowering the roadster top:

A wet or frozen canvas top must not be folded.

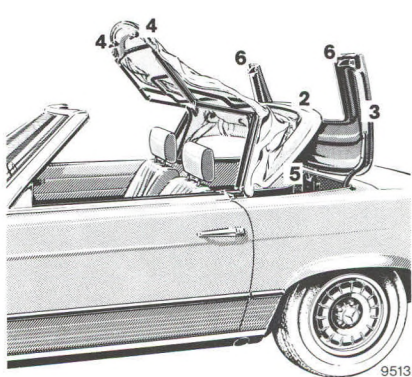

1. Unlock top bow (2) and top storage compartment cover (3) by shifting lever (1) to position C. Lever will automatically return to position B (bow remains unlocked but the top storage compartment cover can be locked). If the top bow cannot be raised in this position, shift lever (7) to position E.
 2. Lift up top bow.
 3. Open top storage compartment cover (3).
 4. Disengage top framework by turning locks (4) inwards. Then detach locking handles.
 5. Swing back top framework and slip top into top storage compartment (5). Stow overhanging canvas in the storage compartment.
 6. Close top storage compartment cover, making sure that both sides (6) are locked.
- Raising the roadster top:
1. Move lever (1) to position C and open top storage compartment cover (3).
 2. Pull top out of storage compartment and rest top framework against windshield header bar.
 3. Tighten top framework by turning locking locks (4) outwards.
 4. Close top storage compartment cover, making sure that both sides (6) are locked.
 5. Move downwards top bow until it locks and tighten with lever (1) (position A).

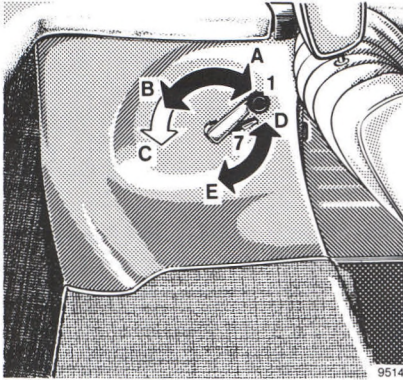

Removal or attachment of the hardtop is best done in a MERCEDES-BENZ service station, although this can be carried out by 2 persons. The roadster top must be completely dry before it is placed in the storage compartment.

To lower or raise the folding top or to remove or attach the hardtop, find two locking handles in a bag stowed in the glove compartment. They are used to engage or disengage the locks in windshield header bar and behind the doors (8). Put locking handles back into the glove compartment after use.

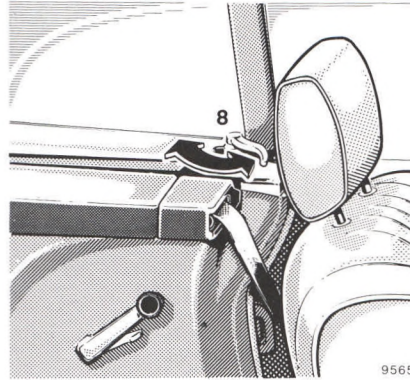

The hardtop is secured at 5 attachment points:

Front = two locks in windshield header bar

Side = one lock behind each door (8)

Rear = top bow lock

Removal of hardtop:

1. Disengage rear locks with levers (1 and 7). (Lever 1 in position B, lever 7 in position E.)
2. Turn side locks (8) rearwards to the stop with locking handles.

3. Insert locking handles into windshield header bar locks and swivel inwards. Detach locking handles.
4. Disconnect plug and socket of the heated rear window in the R-H rear passenger compartment.
5. Cautiously detach hardtop by removing it to the rear.

Attaching hardtop:

1. Shift lever (1) to position B and lever (7) to position D.
2. Carefully position hardtop, simultaneously inserting all locking pins into the respective locks.
3. Insert both the locking handles into the forward locks and swing outwards.
4. Insert locking handles into side locks (8) and swivel forward to the stop.
5. Push lever (1) to position A.
6. Connect plug and socket of the heated rear window in the R-H rear passenger compartment.

Hardtop



The roadster top may become moldy if it is kept enclosed in the storage compartment for an extended period. We recommend you to have the roadster top removed in a MERCEDES-BENZ service station if you intend to drive only with the

hardtop for a lengthy period. Should the roadster top, however, be kept in the car, unfold and air it thoroughly (do not expose to the sun) at regular intervals during the wet and cold seasons.

A special container for the storage of roadster tops or hardtops is available from your MERCEDES-BENZ service station.

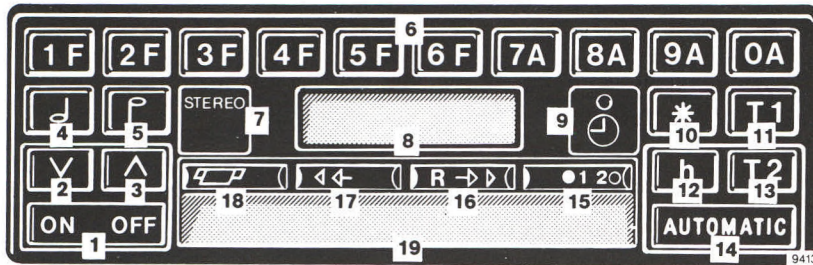

Electronic Radio

- | | |
|---|---|
| 1 On/Off switch ON OFF | 9 Recessed button for setting time ⓪ |
| 2 Volume decrease control ∇ | 10 Function control button * |
| 3 Volume increase control ▲ | 11 Timer button T1 to control switch-on time of radio |
| 4 Bass control B | 12 Time display call button h |
| 5 Treble control T | 13 Timer button T2 to control switch-on time of accessory. |
| 6 Push buttons for AM/FM band selection, station frequency selection, station presetting 1F through 0A and clock setting. | 14 Automatic or manual search station seeker bar AUTOMATIC |
| 7 Stereo indicator light STEREO | 15 Cassette track switch and track indicator ◀ 1 2 ▶ |
| 8 Digital display panel for station frequency, AM/FM band and time display 101.5 MHz 2 | 16 Fast tape rewind locking button ◀ R ▶ |

17 Fast tape forward locking button **▶ R ▶**

18 Cassette eject button **EJECT**

19 Cassette door **|||||**

To turn the radio on or off, the ignition switch must be in position "1" or "2".

To turn the radio ON

Press "ON" side of **ON OFF** switch. The radio will begin operating on the last station tuned to and the last volume and tone setting stored before last turn off.

The radio can also be turned on by inserting a tape cassette through the cassette door.

To turn the radio OFF

Press the "OFF" side of the **ON OFF** switch.

To adjust the volume

To decrease the loudness, press the volume decrease control **∇** ; to increase the loudness, press the volume increase control **▲** .

Radio

To adjust the tone characteristic

To set the radio to a “flat” frequency response, briefly press both tone controls **B** **P** simultaneously.

To produce more bass, press the bass control only **B**. To produce more treble, press the treble control only **P**.

Note:

Repeated pressing of either the bass or treble control will cause the respective tone control to alternate between an increasing and decreasing setting.

To select AM or FM

Press any of the buttons marked **1F** through **6F** to tune the radio to the FM band.

Press any of the buttons marked **7A** through **0A** to tune the radio to the AM band.

To tune to a station

Stations can be tuned in by using automatic search, direct frequency dialing, manual tuning, or by preset push buttons. The frequency of the station selected is displayed digitally on the display panel.

Automatic station search

Switch to the wave band desired by pressing any of the following buttons:

for FM, buttons **1F** through **6F**,
for AM, buttons **7A** through **0A**.

By pressing the right side of the station seeker bar **AUTOMATIC**, the radio searches stations in ascending transmitter frequency sequence, and by pressing the left side, in descending transmitter frequency sequence. The direction

of the automatic search operation can be reversed by pressing either side of the seeker bar **AUTOMATIC**. For fast approach of a station sought, the seeker bar can be held down.

The radio is programmed to automatically search the entire band in three sensitivity modes. During its first sweep, only the most powerful stations received will be selected and locked in. During the next sweep, the less powerful and during the third cycle, also the weak stations will be locked in.

If the station seeker bar is reactivated within eight seconds after the radio selects a station, the automatic search will resume in the sensitivity mode used last. If eight seconds are exceeded before reactivating the bar, the unit will again search for the most powerful stations first.

Direct frequency dialing

In order to select a station with a known frequency, select the wave band, press the function button ***** and then enter the frequency by pressing the corresponding push buttons.

Example:

FM 98.5 MHz	AM 1050 KHz
1 F through 6 F	7 A through 0 A
*	*
9 A 8 A 5 F	1 F 0 A 5 F 0 A

Press any button marked
Press the function button
Enter frequency by pressing

When dialing a frequency directly, the number of the push buttons is not displayed on the panel. The wave band is indicated by showing “MHz” for FM or “KHz” for AM.

Note:

All AM stations have allocated frequencies ending with a “0”.
All FM stations have allocated frequencies ending with an odd (uneven) digit after the decimal point.

Broadcasters sometimes may not give their exact frequency but the next closest even number.

US radio frequency ranges: AM 540 – 1600 KHz
FM 88.1 – 107.9 MHz

Manual tuning (used to fine tune a station or for manual scanning)

After selecting the desired AM or FM wave band, press the function control button *****.

Depress and hold the **AUTOMATIC** (left or right side) button. The frequency will increase or decrease respectively in increments of 0.1 MHz for FM or 1.0 KHz for AM. Release the button when the desired station is tuned in.

If, after pressing the function control *****, the station seeker bar **AUTOMATIC** is not activated within eight seconds, the manual tuning mode is ended automatically.

Safety Note

To avoid distraction of attention from the vehicle’s operation and the road, it is recommended NOT to perform any manual dialing operations by the driver while the vehicle is in motion. Use the automatic station search operation or preset stations instead.

Push button tuning

Six FM stations and four AM stations can be stored in memory and recalled by pressing the appropriate buttons marked **1 F** through **6 F** for FM or **7 A** through **0 A** for AM stations.

To store stations in memory

Any FM station frequency displayed on the panel can be stored on any button marked **1 F** through **6 F** by depressing the button desired and holding it until the display has changed from the “old” setting to a “blank” and then to the new frequency to be stored.

Radio

Showing the “old” setting first allows for reconsideration of the decision to store. If it is desirable to leave the “old” frequency in memory rather than exchanging it with the “new” one, quickly release the button. The “old” frequency will remain in memory.

Any AM station can be stored similarly on any button marked **7A** through **0A**.

Stereo reception

The stereo indicator symbol **STEREO** lights up if a stereo program is received.

The radio is equipped with an automatic stereo/mono switch that electronically switches to mono for clear reception if a weak signal is received. A special circuit provides for a smooth change-over rather than a hard sudden switching, thereby reducing noise and interference.

The stereo indicator will remain lit even if the receiver has changed to the mono mode and will turn off at an antenna signal considered insufficient to provide acceptable reception quality.

Tape Cassette playback

It is recommended to use only good quality cassettes with a playback time of not more than 60 to 90 minutes (C 60) or (C 90).

To start playback, insert a cassette through the cassette door. Push the cassette in until it is locked in its playing position.

When the end of one playing side is reached, the unit switches automatically to reverse for playing the second track.

Manual reverse can be activated by depressing the cassette track switch button **1 2 3**. The built-in indicators show the track of the cassette the unit is playing back.

To stop playback, press the eject button **4**. The unit will automatically eject the cassette and switch to radio reception.

For fast tape rewind press the fast rewind button **R →**. The button will lock into position until the end of the tape is reached or until the eject **4** or fast forward **← 4** button is activated.

Accordingly, for fast forward transport of the tape, press the fast forward button **← 4**.

When the radio is turned off by pressing the “OFF” side of the **ON OFF** switch or by turning the ignition key off, the cassette will automatically be ejected.

Care and maintenance

To avoid a deterioration of the tone quality, occasionally clean the tape head with the special cleaner supplied in your glove compartment or available through your dealer.

To set clock

Turn ignition key to position “1” or “2”.

Briefly press recessed time set button **5** by using a pencil or ballpoint pen.

Enter the time at which you want to start the clock by sequentially pressing four of the top row push buttons **1 F** through **0A**. The time entered will be displayed.

Note:

This is a 24 hour clock and time must be entered in all four digits. A 24 hour clock counts time from midnight to midnight, that is 24 hours. A time of 4:28 PM therefore is counted by this clock as 16:28 hours (12 plus 4:28 hours).

Example 1: To enter 7:30 AM,
press buttons
0A , **7A** , **3F** , **0A**

Example 2: To enter 4:28 PM,
press buttons
1F , **6F** , **2F** , **8A**

The time entered is now stored. To start the clock in accordance with a time signal or other time reference, again briefly press the recessed time set button **Ⓢ**.

A colon sign will appear between the second and third digits **07:30**, to indicate that the clock is activated.

Normally, the display panel will show the frequency the radio is tuned to.

To display time

Briefly press the call button **h**. The time will be displayed for a few seconds.

To use timers **T1 or **T2****

Timer **T1** can be used to automatically turn the radio on at a preset time. Timer **T2** can be used to turn an accessory (e.g., seat heating system) on at a preset time. To set either timer, the ignition key must be in position "1" or "2". Timer **T1** can only turn the radio on with the ignition key in position "1" or "2". Timer **T2** can turn an accessory on without the ignition key inserted in the lock.

To set timers

Press either **T1** or **T2** button, key desired turn-on time into timer as explained under "setting of the clock". To activate timer, e.g., to turn radio on at the preset time, press *****. A colon sign will appear between the second and third digits to confirm activation.

If, at any time, you would like to know the time either timer is set for, depress either button **T1** or **T2**. The time will be displayed on the panel along with a No. 1 or 2 for the respective timer. After a few seconds, the display will change again to the station frequency tuned to. To change the turn-on time, proceed as outlined under "to set timers".

Note concerning timer **T2**

To connect any accessory to this timer, a special relay is required which can be plugged into the receptacle provided on the radio. Separate instructions are required for this operation.

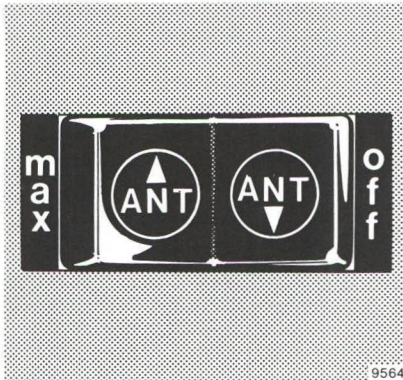

Automatic Antenna

The antenna switch can be actuated with the radio switched on and the key in steering lock positions "1" or "2".

- If the antenna switch is in center position, the antenna extends automatically to a specific height,
- if the antenna switch is engaged in the "max." position, the antenna extends fully,

- if the antenna switch is engaged in the "off" position, the antenna will not extend or will retract completely.

The height of the antenna can furthermore be adjusted continuously by actuating the antenna switch:

- If the antenna switch is in center position, the antenna will extend to a specific height. The antenna

can be further extended or retracted to any height by rocking the switch (not engaging it).

- If the antenna is to be retracted, e. g. for playing cassettes, engage switch in "off" position.

When the key is turned to steering lock position "0" or the radio is turned off, the antenna will retract completely.

Driving



Hood

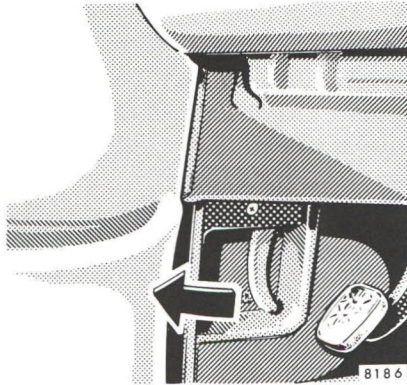

To open, pull handle (below the L-H side of instrument panel) to unlock it. The hood opens to the safety catch stop. Pull lever in radiator grille as indicated by the arrow and lift hood (windshield wiper arms must not be folded out).

To close, press down hood firmly.

Notes:

There is a risk of injury when the hood is open and the engine is running.

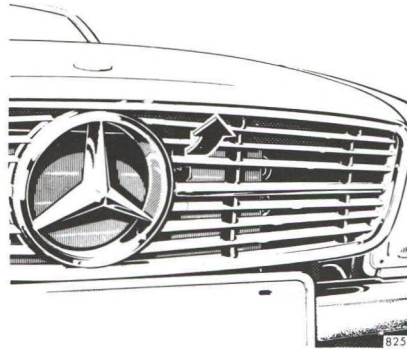

The engine is equipped with a transistorized ignition system. Because of the high voltage it is highly dangerous to touch any components (ignition coil, distributor, spark plug sockets, ignition cables, diagnostic socket) of the ignition system

- if the ignition is "on" and the engine revved manually
- while starting the engine
- with running engine

Parking Brake

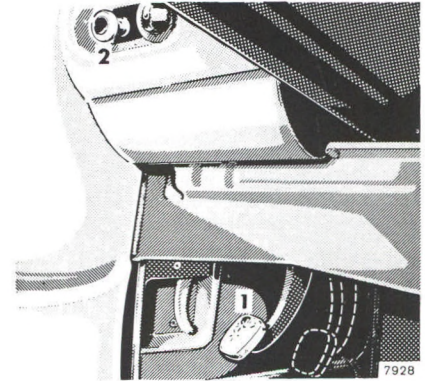

Depress parking brake pedal (1). When the steering lock key is in position "2", the brake warning lamp in the instrument cluster comes on.

To release, pull release button (2) on the instrument panel. The parking brake releases in one rapid movement. The parking brake warning lamp in the instrument cluster must go out.

Have the following items checked regularly and prior to any long trip

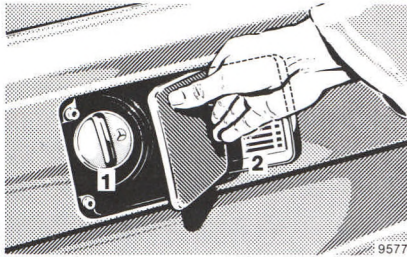

1 Fuel Supply Use unleaded gasoline, for octane rating see "Capacities and last page".

2 Tire Pressure For tire pressure table refer to fuel filler flap or last page. Check at least every other week. For more details see "Wheels, Tires, Changing Wheels".

3 Oil/Fluid Level: Engine, Automatic Transmission See "Checking Fuels, Coolants, Lubricants, etc.", "Fuels, Coolants, Lubricants, etc. and last page".

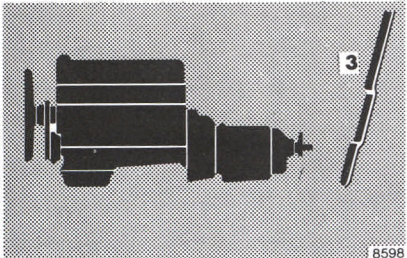

4 Coolant Level See "Checking Fuels, Coolants, Lubricants, etc.", "Fuels, Coolants, Lubricants, etc. and last page".

5 Brake Fluid When the minimum mark on the reservoir is reached, have the system checked (brake lining thickness, leaks).

6 Windshield Washer Replenish with water mixed with windshield washer detergent (container is in the engine compartment).

7 Battery Replenish with distilled water only. See "Electrical System".

Vehicle Lighting Check for function and cleanliness.

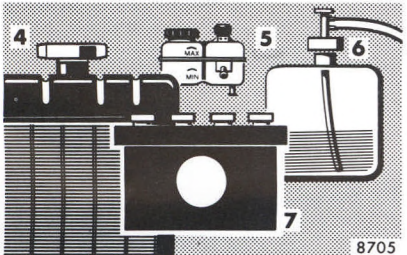

Catalytic Converter Cautions



Your MERCEDES-BENZ is equipped with monolithic catalytic converters, an important element in conjunction with the O₂-sensor to achieve substantial control of the pollutants in the exhaust emissions. Keep your vehicle in proper operating condition by following our recommended maintenance instructions as outlined in your maintenance booklet.

Should any noticeable irregularities in the engine operation occur such as misfiring of one or more cylinders, indicated by audible signs, excessive unburned fuel may reach the converter causing it to

overheat. Continued operation of your vehicle can result in damage to the converter.

For the same reason we caution against:

- Misuse or abuse of your vehicle engine
- Refueling with leaded gasoline
- Excessive idling with cold engine
- Push or tow starting your vehicle with hot engine.

As with any vehicle, do not idle, park or operate this vehicle in areas where combustible materials such as grass, hay or leaves can come into contact with a hot exhaust system, as these materials could be ignited.

We urge your cooperation by following the above instructions to achieve cleaner air.

Engage parking brake or service brake before starting the engine.

Place the gear selector lever in either “N” or “P” position before starting the engine.

Turn key in steering lock to position “2”. The charge indicator lamp must come on.

Cold Engine

Turn key in steering lock clockwise to the stop. As long as the key is held against the stop the starter remains engaged. Do not actuate accelerator. Release key only when the engine is firing regularly.

Hot Engine

Turn key in steering lock clockwise to the stop. As long as the key is held against the stop the starter remains engaged. Do not actuate accelerator. If the engine has not fired after approx. 4 seconds, depress accelerator to the floor and continue cranking until the engine runs smoothly. Release key and back off accelerator after the engine has started.

Turning off

Turn the key in the steering lock to position “0” and only remove the key when the vehicle is at standstill.

If the coolant temperature is very high (e.g. after hard driving on mountain roads), do not shut off the engine immediately but allow it to run on for 1–2 minutes at increased idle speed.

Hints

Due to the installed starter non-repeat unit, the key in the steering lock must be returned to “0” position before a new starting attempt is made.

Observe the oil pressure gauge immediately after starting the engine. In a very cold engine the oil pressure will only rise slowly, some time after the engine has started. Do not rev up the engine before pressure is registered on the pressure gauge.

The charge indicator lamp must go out as soon as the engine has started.

At ambient temperatures of less than $-18^{\circ}\text{C}/0^{\circ}\text{F}$, depress the accelerator three times prior to starting.

Starting and Shifting Gears

The automatic transmission facilitates and simplifies the handling of the vehicle. The individual gears are shifted automatically dependent upon selector lever position, vehicle speed and accelerator position.

Hint

When parking the vehicle or if working on the vehicle with the engine running, depress parking brake pedal and move selector lever to position "P".

Do not store any objects in the driver's footwell area because they could become lodged under the operator's pedals thus rendering these controls partially or totally inoperative.

Starting

Shift selector lever to the desired driving position only when the engine is idling and the service brake is applied. Do not release the brake before moving off. The vehicle may otherwise start creeping when the selector lever is in a driving position.

Test service brake after driving off.

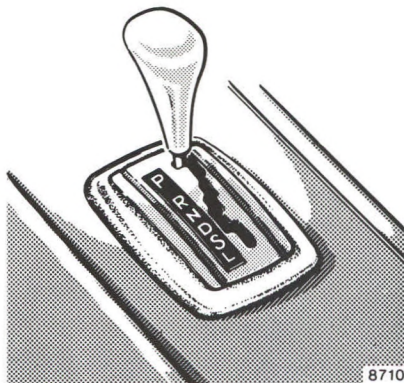

Warm up the engine smoothly. Do not place full load on the engine until the operating temperature has been reached.

Accelerator position

Partial throttle = early upshifting
= normal acceleration

Full throttle = retarded upshifting
= maximum acceleration

Depressing the accelerator beyond full throttle to kickdown position means downshifting to the next lower gear and thus maximum acceleration. If you ease up on the

accelerator after having attained the desired speed, the transmission will shift up again.

Gearshifting is controlled by the vehicle speed.

Selector Lever Positions

The automatic gear shifting process can be adapted to specific operating conditions by means of the selector lever.

"P" Parking lock.

The parking lock is an additional safeguard when parking the vehicle. Engage only when the car is stationary.

"R" Reverse gear.

Shift reverse gear only with the vehicle at halt.

"N" Neutral.

No power is transmitted from the engine to the rear axle. When the brakes are released, the vehicle can be moved freely (pushed, towed or tow-started). Do not engage "N" when driving except when the vehicle is in danger of skidding (e.g. on icy roads).

See page 48.

“D” Drive.

All gears are available. The vehicle starts off in 1st gear. Position “D” affords optimum driving characteristics under all normal operating conditions.

“S” Slope.

Upshifting to 3rd gear only. Suitable for moderate ascents and descents. As the transmission shifts up to 3rd gear only, this position permits the utilization of the engine braking effect.

“L” Low.

Upshifting to 2nd gear only. For driving on steep mountain passes, for trailer operation in mountainous regions, for driving under severe operating conditions and as braking position on extremely steep declines.

Do not exceed top speeds in the individual selector lever positions. Refer to speedometer markings.

Maneuvering

To maneuver in restricted area, e. g. when pulling into a parking space, control the car speed by gradually releasing the service brake.

Accelerate gently and do not pump the accelerator. To rock a car out of soft ground (mud or snow), alternately shift one forward gear range and the reverse gear at partial throttle.

Trailer operation

Do not allow the engine speed to drop too low at uphill gradients to prevent the engine from laboring at

low RPMs. Depending on the degree of the incline, shift selector lever to positions “S” or “L” early enough to maintain engine rpms within best torque range.

Stopping

When stopping, e. g. on a traffic light, hold vehicle with service brake while leaving selector lever in a drive position; do not hold vehicle by accelerating engine. This will help to avoid unnecessary heat-buildup in transmission.

Safe Driving

Power assistance:

Do not attempt to move or roll the vehicle with the engine not in operation, as engine-driven accessories such as the power steering system or power brakes are not “powered”, therefore, requiring substantially more effort for their operation even though they always remain mechanically operative.

Tires:

Do not allow your tires to wear down too far. With less than appr. 3 mm/1/8 in of tread, the antiskid properties on a wet road are sharply reduced.

Depending upon the weather and/or road pavement, the grip of the tires varies widely.

The retention of the specified tire pressure is essential. This applies particularly if the tires are subjected to high loads (e. g. high speeds, heavy loads, high ambient temperatures).

Aquaplaning:

Depending on the depth of the water layer on the road, aquaplaning may occur even with tires still showing the full tread depth, and even at low speeds. Avoid track grooves in the road and apply brakes cautiously in the rain.

Tire friction:

Dry road = 100 %

Wet road = from approx. 50 % to approx. 80 % (be particularly cautious on wet and dirty roads)

Icy road = approx. 15 %

A given speed at which a vehicle driven on dry roads can still be fully controlled must be reduced when the same vehicle is to be driven safely on a wet or icy road.

You should pay particular attention to the condition of the road as soon as the prevailing temperatures fall close to the freezing point.

If ice has formed on the road (e. g. due to fog), a thin film of water is then quickly produced on the ice which substantially reduces the grip of the tires. Under such

weather conditions, drive, steer and brake particularly carefully.

We recommend M+S radial-ply tires for the cold season. On ice or packed snow, they can reduce your stopping distance as compared with summer tires. Stopping distance, however, is nevertheless considerably greater than when the road is wet or dry.

Brakes:

When driving down long and steep declines, relieve the brakes by engaging selector lever position “S” or “L”. This prevents overheating of the brakes and reduces brake pad wear.

After hard braking it is advisable not to switch off the engine right away but to drive on for some time so the air stream will cool down the brakes faster.

When driving in heavy rain for some time without applying the brakes, the first braking action may be somewhat retarded and increased pedal pressure may be necessary. For this reason, stay further away from vehicle in front.

The condition of the parking brake should be checked during every maintenance service. Furthermore it is recommended to exert once or twice between the regular maintenance services, a maximum pressure of 10 kp/22 lb on the parking brake pedal for 10 seconds while travelling at a speed around 50 km/h/30 mph on dry road. Pull release knob during this process! Repeat procedure once or twice. Exercise care, the stoplamps do not work. Have all inspections of and work on the brake system carried out by a MERCEDES-BENZ service station. If the parking brake is released and the brake warning lamp in the instrument cluster comes on, the brake fluid level in the reservoir is too low.

Brake pad wear or a leak in the system may be the reason for loss of brake fluid in the reservoir.

Have the brake system inspected at a MERCEDES-BENZ service station without delay.

Install only brake pads recommended by us. If other than recommended brake pads are installed, the braking properties of the vehicle can be affected to an extent that the safety is substantially impaired.

Brake Pad Wear Indicator Lamp

The brake pad wear indicator lamp in the instrument cluster comes on when the key in the steering lock is turned to driving position "2" and it must go out when the engine is running. If the indicator lamp lights up during braking, this shows that the front wheel brake pads are worn down.

Have brake system checked in a MERCEDES-BENZ service station as soon as possible.

Brake Fluid

During the course of the operation of the vehicle, the boiling point of the brake fluid is continuously being reduced through the absorption of moisture from the atmosphere. Under extremely hard operating conditions, this moisture content can lead to the formation of vapor in the system thus reducing the system's efficiency. The brake fluid must therefore be replaced annually, preferably in the spring. It is recommended to use only brake fluid approved by MERCEDES-BENZ.

Your MERCEDES-BENZ dealer will provide you with additional information.

Charge Indicator Lamp

Should the charge indicator lamp fail to come on prior to starting when the ignition key is in position "2" or should it fail to go out after starting or during operation, this indicates a fault which must be repaired at a MERCEDES-BENZ service station as soon as possible.

Safe Driving

Oil Pressure Gauge

The oil pressure may drop at idle speed to 0.5 bar/7.1 psi if the engine is at operating temperature. This will not jeopardize its operational reliability. Pressure must, however, rise immediately upon acceleration.

The oil pressure gauge does not provide any information concerning the oil level in the engine.

Coolant Temperature Gauge

Due to the pressurized cooling system, the coolant only starts boiling at a temperature of approx. 125° C/ 257° F with an antifreeze-blended coolant fill protecting down to -30° C/-22° F (see also "Fuels, Coolants, Lubricants, etc.").

During severe operating conditions and stop-and-go city traffic the coolant temperature must not rise above the red marking.

Emission Control

Certain systems of the engine serve to keep the toxic components of the exhaust gases within permissible limits required by law. (Nevertheless, we urgently advise you not to let the engine run in a closed garage.) These systems, of course, will function properly only when maintained strictly according to factory specifications. Any adjustments on the engine should, therefore, be carried out only by qualified MERCEDES-BENZ technicians. The adjustments of the engine should not be altered in any way. Moreover, the specified service and maintenance jobs must be carried out regularly according to MERCEDES-BENZ servicing requirements. For details refer to Maintenance Booklet.

Engine Oil Consumption

Engine oil consumption can only be determined after a certain mileage has been covered. During the break-in period, higher oil consumption may be noticed and is normal. Frequent high engine speed operation will also cause increased oil consumption.

The First 1500 km/1000 Miles

The more cautiously you treat your engine during the break-in period, the more satisfied you will be with its performance later on. Therefore, drive your vehicle during the first 1500 km/1000 miles at moderate vehicle and engine speeds.

During this period, avoid heavy loads (full throttle driving) and high RPMs (no more than $\frac{2}{3}$ of maximum permissible speed in each gear) and do not force the engine to labor at low engine speed.

Avoid accelerating by kickdown. It is not recommended to brake vehicle by means of manually shifting to a lower gear. We recommend to select positions "S" or "L" only at moderate speeds (for hill driving).

After 1500 km/1000 miles speeds may gradually be increased to the permissible maximum.

Driving Economically

Gauge for Economical Driving (ECONOMY)

The gauge for economical driving indicates the fuel consumption tendency during the various driving modes.

If, while driving, the pointer travels to the right into the red field, this indicates an increase in the momentary fuel consumption.

In order to drive economically you should try to keep the pointer of the gauge away from the red field in all gears, by avoiding hard acceleration as much as possible.

Use selector lever position "D" while driving under all normal operating conditions. Using selector lever positions "S" or "L" can involve an increased consumption of between 25 – 80 %.

Special Operating Conditions

Winter Driving

Have your car winterized in a MERCEDES-BENZ service station before the onset of winter.

- Engine oil change: If no "all year round" engine oil is used, fill with recommended winter oil. For viscosity and capacity refer to "Fuels, Coolants, Lubricants, etc. and last page".
- Antifreeze in the coolant: Check antifreeze protection periodically. For capacity refer to "Fuels, Coolants, Lubricants, etc.".
- Additive in the windshield washer system: Add windshield washer solvent to the water in the windshield washer system.

Special Operating Conditions

- **Test battery:** Battery capacity drops with decreasing ambient temperature. A well charged battery ensures that the engine can always be started, even at low ambient temperatures.
- **Tires:** We recommend M+S radial tires on all wheels for the winter season. Observe permissible maximum speed for M+S radial tires and the legal speed limit.

Hints for Driving

The most important rule for slippery or icy roads is to drive sensibly and to avoid abrupt acceleration, braking and steering action. Do not use the cruise control system under such conditions.

When the vehicle is in danger of skidding, move selector lever to position "N". Try to keep the vehicle under control by means of corrective steering action.

Provided the traffic conditions will allow, only brake in a way that the wheels are locked for no more than fractions of a second as otherwise the steerability of the vehicle is lost.

Road salts can adversely affect braking efficiency. Increased pedal force may become necessary to produce the normal brake effect. We therefore recommend depressing the brake pedal repeatedly when travelling on salt-strewn roads at length. This can bring road salt impaired braking efficiency back to normal. A prerequisite is, however, that this is possible without endangering other drivers on the road.

If the vehicle is parked after being driven on salt treated roads, the braking efficiency should be tested as soon as possible after driving is resumed while adhering to the safety requirements. Should the braking efficiency have deteriorated considerably it can be improved again by braking several times.

Tire Chains

Tire chains can only be used on the driving wheels. Use only chains tested and recommended by us. Any MERCEDES-BENZ service station will readily advise you. Retighten newly mounted tire chains after a few miles of driving. Do not exceed permissible maximum speed of 50 km/h/ 30 mph. On clear roads, remove the chains as soon as practicable. Adhere to the manufacturer's mounting instructions.

Traveling Abroad

Abroad, too, there is a widely-spread MERCEDES-BENZ service network at your disposal. If you travel into areas which are not listed in the index of your service station booklet, you should request pertinent information from your dealer.

Vehicle Care



MERCEDES-BENZ Maintenance System

Like any other mechanical equipment, the vehicle requires care and maintenance.

A maintenance booklet is delivered with your car listing all the maintenance jobs that must be carried out after the following mileages:

- Once after 1300–1600 km/ 800–1000 miles.
- After 12 000 km/ 7500 miles.
- After 24 000 km/15 000 miles and thereafter every 24 000 km/ 15 000 miles, but at least once every two years.

We would also like to draw your attention to the hints contained in the maintenance booklet covering necessary lubrication service every 12 000 km/7500 miles, additional maintenance jobs every 48 000 km/

30 000 miles and MB individual maintenance as required.

Renew brake fluid once a year, preferably in spring. Use only brake fluids recommended by MERCEDES-BENZ.

The vehicle must receive the prescribed maintenance and/or lubrication work at the specified intervals as listed in the maintenance booklet. Verification of performance of such maintenance/lubrication work should be recorded in the spaces provided in the maintenance booklet.

The maintenance jobs are described in detail in a manual which you can order from your MERCEDES-BENZ service station.

Severe Operating Conditions

In the case of severe operating conditions or heavy use mainly in city traffic or over short distances, frequent mountain driving, poor roads, dusty and muddy conditions, trailer operation, hard and sporty driving, etc. it may be necessary to inspect e.g.

- the tires
- air cleaner (clean or renew element)

at shorter intervals.

Any MERCEDES-BENZ service station will be pleased to give you expert and individual advice.

MERCEDES-BENZ Maintenance System

Engine Oil Change and Filter Change

To be carried out every 12 000 km/ 7500 miles, but at least once a year if year-round multigrade oil is used. Otherwise at least twice a year (in spring and fall).

Under severe operating conditions the oil and filter should be changed every 6000 km/3750 miles.

For regular oil level checks, refer to "Checking Fuels, Coolants, Lubricants, etc."

Automatic Transmission – Fluid and Filter Change

To be carried out every 48 000 km/ 30 000 miles according to the maintenance booklet.

Under severe operating conditions, have the automatic transmission fluid changed every 24 000 km/ 15 000 miles without filter change.

Spare Parts Service

All MERCEDES-BENZ service stations maintain a stock of original spare parts required for maintenance and repair work. In addition, strategically located parts distribution centers provide quick and reliable parts service.

More than 200 000 different spare parts, even for rather old vehicle models, are available.

MERCEDES-BENZ original spare parts are subjected to most severe quality inspections. Each part has been specifically developed, manufactured or selected for and adapted to MERCEDES-BENZ vehicles. Therefore, MERCEDES-BENZ original spare parts should be installed.

Cleaning and Care of the Vehicle

In operation, your vehicle is subjected to a great amount of varying external influences which, if gone unchecked, can attack the paint-work as well as the underbody and cause lasting damage.

Such damage is caused not only extreme and varying climatic conditions, but also by air pollution, road salt, tar, gravel and stone chipping. Grease and oil, fuel, coolant, brake fluid, bird droppings, tree resins, etc. should be immediately removed to avoid paint damage. Frequent washing, however, reduces and/or eliminates the aggressivity and potency of the above adverse influences.

Special car-care measures may be necessary to deal with unfavorable conditions; for example, near the coast, in industrial areas (smoke, exhaust emissions), or during winter operation.

You should check over your vehicle from time to time for stone chipping or other damage. Any damage should be repaired as soon as possible.

In doing so, do not neglect the underside of the car. A prerequisite for a thorough check is a washing of the underbody followed by a rustproofing treatment.

Your vehicle has been treated at the factory with a wax-base rustproofing in the body cavities which will last for the lifetime of the vehicle. Post-production treatment is neither necessary nor recommended by MERCEDES-BENZ because of the possibility of incompatibility between materials used in the production process and others applied later.

After every engine cleaning you should have the engine compartment rustproofed. Before rustproofing, all control linkage bushings

have to be lubricated with hydraulic oil (check with your local MERCEDES-BENZ dealership for recommended brands).

We have selected car-care products and compiled recommendations which are specially matched to our vehicles and which always reflect the newest in technological standing. You can obtain MB car-care products at every MERCEDES-BENZ service station.

Scratches, corrosive deposits, corrosion or damage due to negligent or incorrect care cannot always be removed with the car-care products recommended here. In such cases it is best to seek aid at your MERCEDES-BENZ service station.

The following topics deal with the cleaning and care of your vehicle and give important "how-to" information as well as references to recommended MB car-care products.

Car Wash

Before washing your vehicle, remove insect residues. The car should not be washed in the sun.

Thoroughly spray the car with a diffused jet of water. Direct only a very weak spray towards the ventilation intake. Use plenty of water and rinse the sponge and chamois frequently. Rinse with clear water and thoroughly wipe dry with a chamois.

If the vehicle has been run through an automatic car wash – in particular one of the older installations – rewipe the recessed sections provided in the tail lamps (for improved prevention of soiling) if necessary. No solvents (fuels, thinners etc.) must be used.

In the winter, thoroughly remove all traces of road salt as soon as possible.

When washing the car underbody, do not forget to clean the inner sides of the wheels.

Tar Stains

Quickly remove tar stains before they dry and become more difficult to remove.

Window Cleaning

Use a window cleaning solution on very dirty or oil-stained windows. Clean windshield wiper blades with a clean cloth and washing solution. Replace blades once or twice a year.

Plastic Parts, Rubber Parts and MB-Tex Upholstery Covers

Do not use oil or wax on these parts.

Seat Belts

The webbing must not be treated with chemical cleaning agents. Use only clear, lukewarm water and soap. Do not dry the webbing at temperatures above 80° C/176° F or in direct sunlight. Never bleach or re-dye the webbing.

Steering Wheel, Instrument Cluster and Selector Lever

Use a gentle dish-washing detergent or mild detergent for delicate fabrics as a washing solution. Wipe with a cloth moistened in lukewarm solution. Do not use scouring agents.

Upholstery

Leather: Wipe leather upholstery with a damp cloth and dry thoroughly. Exercise particular care when cleaning perforated leather as its underside should not become wet.

Paintwork

Do not apply wax if your car is parked in the sun or if the hood is still hot. For maximum protection, the paintwork should be waxed approximately once every three months. Use the appropriate MERCEDES-BENZ Touch-Up Stick for quick and provisional repairs of minor paint damage.

Light Alloy Wheels

If possible, clean wheels once a week with lukewarm water and autoshampoo. Use an ample supply of water.

To remove stubborn marks, use polish or paint cleaner and apply with buffing cloth or a soft cloth.

Ornamental Moldings (Chrome-Plated, Aluminium)

For regular cleaning and care of very dirty chrome-plated parts, use a chrome cleaner.

Roadster Top

(Rubber-coated Canvas)

Stow only a completely dry top in the storage compartment. If the top is kept in the storage compartment for a lengthy period, unfold and air it well with the windows down from time to time.

Remove bird droppings immediately. The organic acid swells the rubber and causes the top to leak.

In general regular spraying or cleansing with clear water will do. Wash top only when heavily soiled, not every time the car is washed.

Caution: Never use any gasoline, thinner, tar and stain removers or similar organic solvents to clean top or rear window.

Dry cleaning:

Brush top (always from front to rear) with a soft-bristled brush.

Wet cleaning:

Brush the dry top. Wash with a mild detergent and an ample supply of lukewarm water by wiping the canvas with a soft-bristled brush or a sponge from front to rear. Then cleanse thoroughly with clear water.

If only parts of the top have been washed, wet the entire top at the end of the proceedings and allow the unfolded and tightened top to air-dry. Wipe the rear window with a cloth soaked with a detergent and rub dry. Do not use sharp-edged instruments for the removal of ice and snow.

Important!

The seams of the top may start to leak due to improper care and cleaning, as well as due to usage over a long period of time. A resealing of the top seams can be carried out at every MERCEDES-BENZ service station.

Practical Hints



Practical Hints

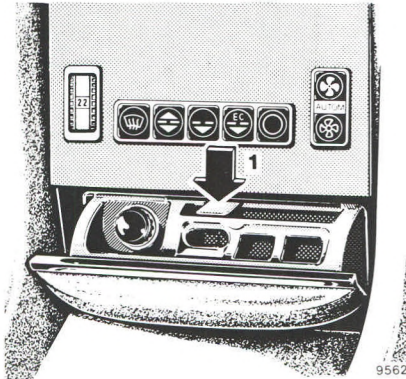

Ash tray

Removal ash tray:
Pull out ash tray up to the stop.
Depress center locking spring (1)
and remove ash tray.

To install ash tray:
Position ash tray squarely and
push in.

Luggage or Ski Racks

The only type of rack to be mounted on the roof we recommend is the drip rail mounted type which has no other supports (suction cups or legs) to support the rack on the roof. Such supports may lead to marring of the paint or even denting of the roof if excessive weight is placed on the rack. Your MERCEDES-BENZ dealer can give further advice.

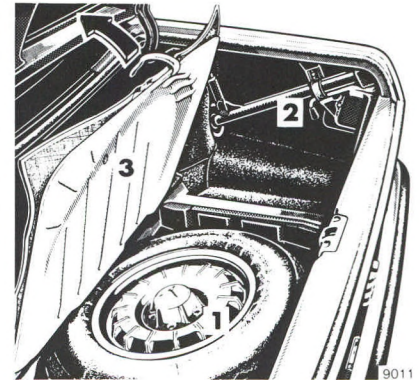

Spare Wheel, Jack, Vehicle Tool Kit

Spare wheel (1) is stowed in a trough below the folding trunk floor (3).

Jack (2) and tools are located in the trunk on the right side.

Note:

The jack is designed exclusively for jacking up the vehicle at the jack tubes provided on either side of the vehicle. Jack stands must be used when working under the vehicle.

Wheels, Tires

In case of replacement we recommend you use tires of identical design, version and brand.

See any MERCEDES-BENZ service station for information on tested and recommended wheels and tires for summer and winter operation. They will also offer more advice concerning tire service and purchase. Mount single newly acquired tires on the front wheels. If any tires are replaced and the spare tire is new and of the same make and version, mount the spare wheel on the vehicle as road wheel. We recommend that you break in new tires for approx. 100 km/60 miles at moderate speed.

On new rims it is imperative that the wheel securing bolts be retightened after approx. 800 km/500 miles. On new vehicles retightening is carried out in the course of the 1st inspection. Retightening is also necessary when new wheels are fitted at a later date, e.g. when the spare wheel is used for the first time or when a new set of wheels with M+S tires is fitted.

For tire specifications, refer to "Technical Data".

Rotating wheels:

The wheels can be rotated according to the degree of tire wear while retaining the same sense of rotation. Rotating, however, should be carried out before the characteristic tire wear pattern (shoulder wear on front wheels and tread center wear on rear wheels) becomes visible at a mileage of 5000–10 000 km/3000–6000 miles as otherwise the driving properties deteriorate.

Slowly leaking air (e.g. due to a nail in the tire) may cause damage to the tire such as tread separation. Regular tire pressure checks at intervals of no more than 14 days are therefore essential. For the tire pressure checks, keep in mind that hot tires show higher pressure than cold tires. See tire pressure chart on last page.

Should the tire pressure decrease constantly, check whether foreign objects have penetrated the tire or if rim or valve allow the air to leak.

Thoroughly clean the inner side of the wheels any time you rotate the wheels or wash vehicle underside.

Dented or bent rims cause tire pressure loss and damage to the tire beads. For this reason, check rims for damage at regular intervals.

The rim flanges must be checked for wear before a tire is mounted. Remove burrs, if there are any.

Observe wheel bolts!

- 1 For forged light alloy rims only
- 2 For steel rims only

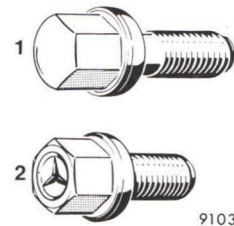

Caution:

Do not use the long wheel bolts (1) intended for light alloy wheels to mount steel rims. Use only the shorter bolts (2) for the steel rims.

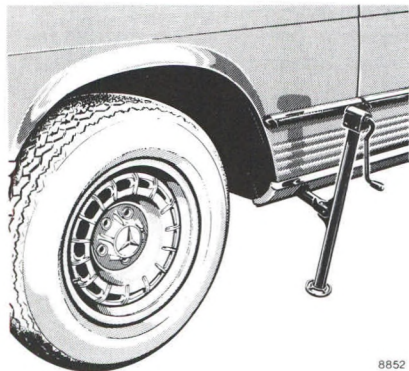

8852

Changing Wheels

1. Depress parking brake pedal.
2. Move selector lever to position "P".
3. Safeguard vehicle against rolling off by using chocks or similar. Place chocks under both opposite wheels (on downhill side), on a level road on both sides of the opposite front wheel when changing a rear wheel.
4. Using the combination wrench, loosen but do not yet remove the wheel bolts.

5. Clean jack supporting tube, if necessary. (Jack tubes are behind the front wheel housings and in front of the rear wheel housings.)
6. Insert jack arm into the tube hole up to the stop. Position the jack so that it will always be vertical as seen from the side, even on inclines. Jack up the vehicle until the wheel is clear of the ground.
7. Then back out the wheel bolts. Protect bolt threads from dirt and sand. Remove the wheel.

Note:

It must be ensured that light alloy rims are not dropped on their outside face since this may damage the plastic center hub cover.

8. Adjust the jack to allow the wheel to be slipped on without being lifted.
9. Slip on spare wheel and press against wheel mounting flange. Screw in wheel bolts.

10. Lower car and remove jack. Tighten the five bolts evenly by going around the wheel and tightening every other bolt until all the bolts are tight. Observe a tightening torque of 10 mkp/72 lb-ft.
11. Correct tire pressure.

Tire Inflation Pressure

A table (see fuel filler flap or last page) lists the tire inflation pressures specified for summer and winter tires as well as for the varying operating conditions.

Tire temperature and pressure increase with the vehicle speed. Tire pressure should therefore only be corrected on cold tires. Correct tire pressure in hot tires only if pressure has dropped below the data listed in the table and the respective operating conditions are taken into consideration.

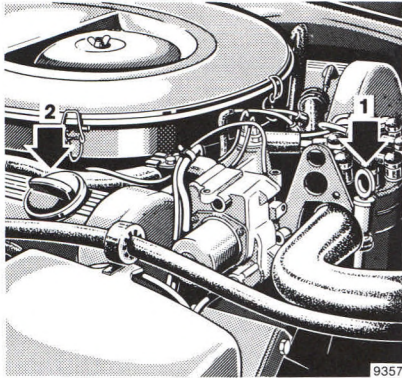

Engine Oil Level Check

- 1 Dipstick
- 2 Oil filler hole

Check engine oil level at regular intervals, after refueling, with the engine at operating temperature and shut off.



The vehicle should be parked on level ground and the oil level must be somewhere between the lower and the upper mark on dipstick (1); do not replenish in excess of the upper mark.

Wipe dipstick before any oil level measurement. To determine the oil level, check both sides of the dipstick. Always determine an accurate oil level by means of the straight horizontal marking formed by the oil on one side of the dipstick.

For viscosity and capacity, see "Fuels, Coolants, Lubricants, etc., and last page".

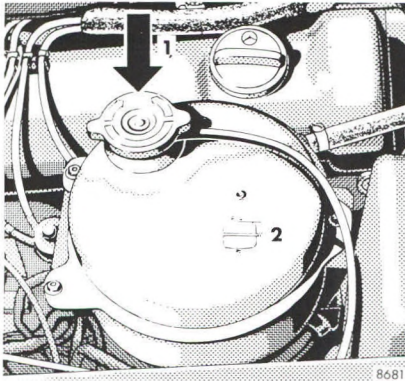

1 Coolant Filler
2 Marking for coolant level

Checking Coolant Level

The coolant reservoir with filler neck is arranged away from the radiator. To replenish coolant, the car must be on level ground.

Do not remove pressure cap on coolant reservoir if engine temperature is above 90° C/194° F. Allow engine to cool down before removing cap. The coolant reservoir contains hot water and is under pressure.

First turn cap to first notch to relieve excess pressure using a rag. If opened immediately, hot scalding fluid and steam will be blown out under pressure.

If a small amount of coolant has to be added (due to evaporation of water), plain water can be added.

If a larger quantity of coolant has to be added, a 50/50 mixture of water and antifreeze should be used.

The coolant level must reach:

- the mark indicated on the reservoir when the coolant is cold
- approximately 2 cm/0.8 in higher when the coolant is hot

The drain plugs are situated on the R-H and L-H engine side and on the radiator bottom.

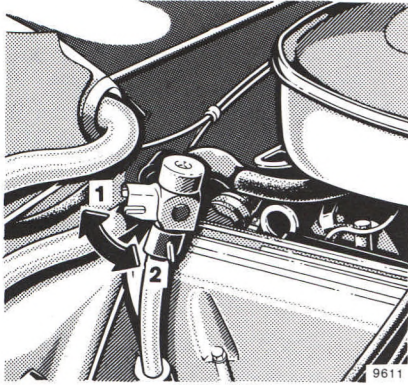

Automatic Transmission Fluid Level

At regular intervals, check the fluid level of the automatic transmission together with the engine oil level prior to every long trip.

Check transmission fluid level with the engine idling, parking brake engaged and selector lever in position "P". The vehicle must be parked on level ground. Prior to the check, allow engine to idle for approx. 1 to 2 minutes.

Measure oil level with the dipstick completely inserted and the locking lever released (1).

Painstaking cleanliness must be observed! To wipe the dipstick, use a clean, lint-free cloth (preferably leather). To fill the transmission with fluid, only pour it through a fine-mesh filter into the dipstick opening. Even the slightest impurity may cause operational troubles.

The oil level in the transmission is dependent upon the oil temperature. The maximum and minimum oil level marks on the dipstick are

applicable references only if the transmission fluid has reached its normal operating temperature of 80° C/176° F.

If, however, the transmission fluid cools down to 20–30° C/68–86° F, which is the normal shop temperature range, then the maximum oil level will be approximately 5 mm/0.2 in below the minimum mark on the dipstick. We stress this point because an oil change is normally performed when the transmission oil has cooled down to shop temperature.

The fluid level must not exceed the dipstick maximum mark with the fluid at operating temperature. Drain or siphon off excess fluid, if required.

Then push dipstick all the way in and swing locking lever downwards (2).

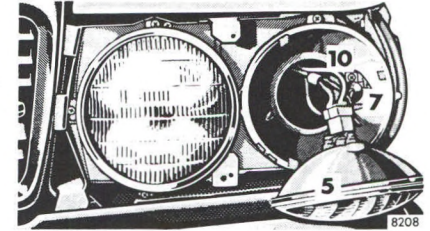
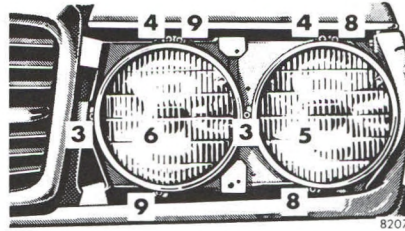
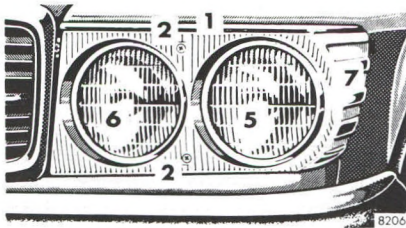

Replacing Bulbs

To remove, push the bulb in and turn to the left, then lift the bulb out.

To install, grip the bulb with a paper tissue or similar cloth, align the pins on the base of the bulb with the grooves in the bulb socket, push in lightly and turn to the right until the stop is felt.

Install only bulbs of prescribed wattage. Refer to "Technical Data and last page".

Headlamp Aiming

Correct headlamp aiming is of paramount importance to the roadworthiness of the car. Check and readjust headlamps at regular intervals and invariably when a lamp has been replaced.

Front Lamps

- 1 Cover
- 2 Securing screws for cover
- 3 Horizontal aiming screws
- 4 Vertical aiming screws
- 5 High and low beam sealed-beam unit (type 2):
Loosen clamping screws (8), remove retaining ring and unit, disconnect plug and socket on unit.
- 6 High beam sealed-beam unit (type 1):
Loosen clamping screws (9), remove retaining ring and unit, disconnect plug and socket on unit.
- 7 Side marker lamp:
Remove unit (5), loosen clamping screw (10) and detach lamp holder. Depress bulb, turn left and pull out.

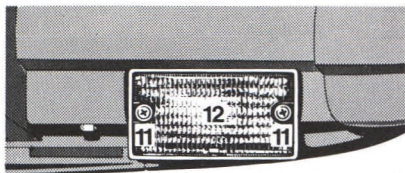

8458

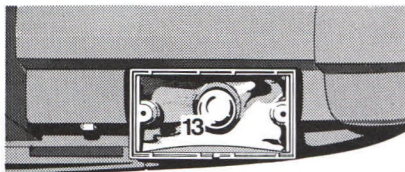

8459

- 13 Bulb for turn signal, clearance and standing lamps:

The lamps are located below the bumper.

Loosen securing screws (11) and remove lens (12).

Depress bulb (13), turn left and pull out. When replacing the lens, it must be ensured that the lug in the lens is at the bottom.

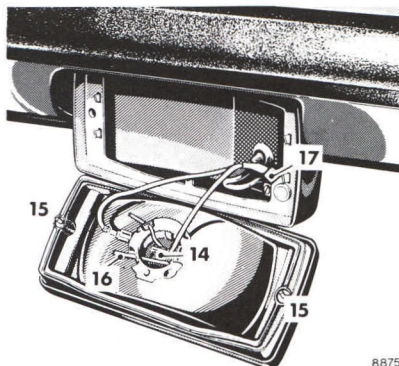

8875

- 14 Bulb for fog lamp: Loosen securing screws (15) and remove housing. Detach holding spring (16), remove bulb (14) and disconnect plug (17).

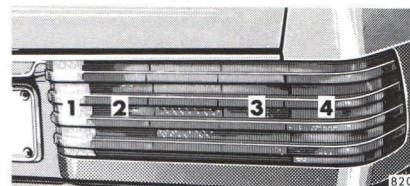

8203

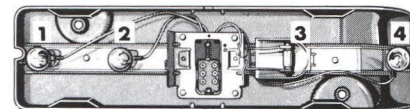

8203

Tail Lamp Assembly

Remove both knurled nuts in the trunk and pull off lens assembly. To replace the bulbs, depress, turn left and pull out.

- 1 Backup lamp
- 2 Stop lamp
- 3 Tail, parking and standing lamp
- 4 Turn signal lamp side marker lamp

Electrical System

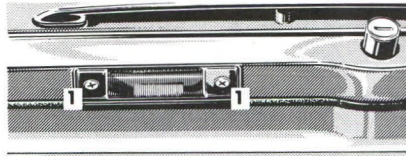

8212

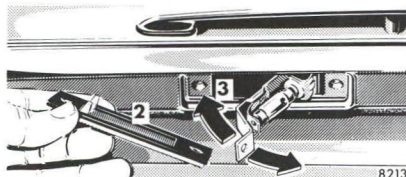

8213

License Plate Lamp

Loosen both the securing screws (1) of the lamp, detach lens with gasket (2) and pull down lamp holder (3) on the L-H side. When replacing the lens, it must be assured that the lug in the lens is on the L-H side.

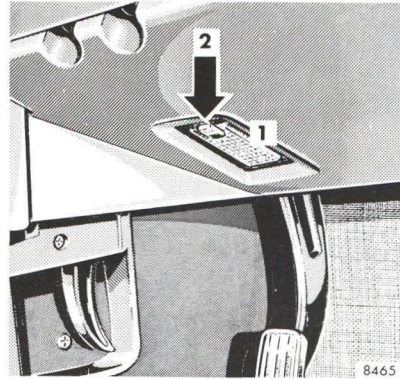

8465

Footwell Lamps

Press off lamp (1) at the nose (2), replace bulb and press lamp on again.

Dome Lamps

To replace the bulb, pull out lamp.

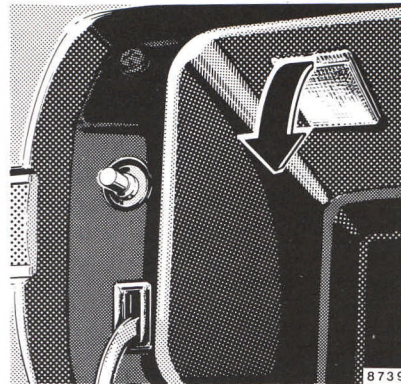

Glove Compartment Lamp

To replace the bulb, pull out lamp.

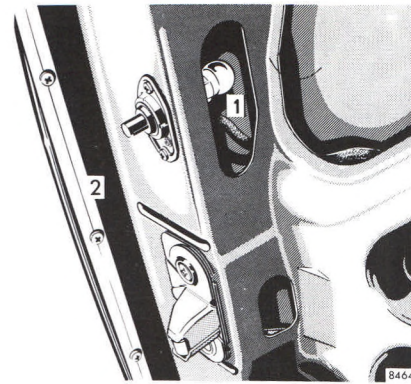

Trunk Lamp

The trunk lamp (1) is easily accessible when the trunk lid (2) is opened. To replace the bulb, depress, turn counterclockwise and take it out.

Electrical System

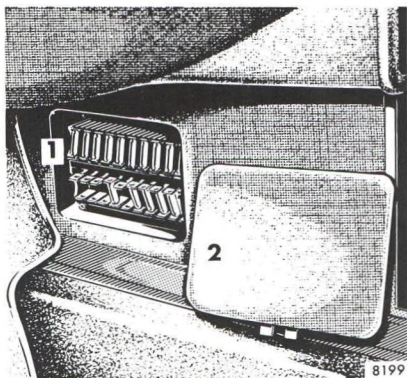

Fuses

The fuse box (1) is accommodated in the R-H side floor space.

A table in the fuse box cover (2) depicts all the protected electrical units.

Fuses must not be repaired or bridged.

Spare fuses for emergencies (observe amperage and color) are stowed with the tools.

Diagnose the cause of a short circuit before replacing a burned-out fuse.

Battery

The battery is located in the trunk.

Replenish with distilled water approximately every 4 weeks, and more often in summer and in hot zones.

Do not use metal funnels and do not perforate the diaphragm of the battery overfill protection.

The battery is filled to the maximum level when the water level in the cell filling chamber stops going down.

If battery acid is to be extracted for battery diagnosis purposes, perforate the diaphragm with the hydrometer or the tube attached to it.

Coat battery terminal clamps with acidproof grease. Keep battery clean and dry.

Only tow vehicle with the battery connected.

Only charge battery with a battery charger when it is disconnected from the vehicle electrical circuit.

Note:

While the engine is running the battery terminal clamps must not be loosened or detached as otherwise the alternator and other electronic units would be damaged.

Spark Plugs

This vehicle is equipped with spark plugs as required for driving in the USA. Should additional information be necessary, your MERCEDES-BENZ dealer will be happy to offer advice.

Towing eyes are situated underneath the R-H front and rear end. Use a solid towing link such as a towbar.

Only tow-start vehicle with the battery connected and the key in steering lock position "2".

Caution: Please keep in mind that considerably more effort is necessary to steer and brake the car while the engine is not running since there is no servo-assistance.

Emergency Engine Start (Tow-starting)

The engine must be cold if it is to be started by towing or pushing the vehicle.

Never start a hot engine by towing or pushing the vehicle as the catalyts might otherwise suffer damage.

Move selector lever to position "N". Turn key in steering lock to position "2" and have vehicle towed.

After reaching a speed of 30 km/h/ 18 mph, maintain this speed for about one minute in order to ensure sufficient oil pressure in the transmission.

To start the engine, move selector lever to "L". Depress accelerator fully. After starting the engine, release accelerator and return shift lever to "N" immediately.

If the engine fails to fire within a few seconds, return the selector lever from "L" to "N" as otherwise the transmission may be damaged.

For another starting attempt, tow car again for a short while with the selector lever in position "N" and then repeat starting procedure.

The same procedure may be used for starting the engine while rolling downhill.

Towing the Vehicle

The vehicle may be towed with the driving wheels on the ground and the selector lever in position "N" for distances up to 120 km/75 miles and at a speed not to exceed 50 km/h/30 mph.

To positively avoid a possibility of damage to the transmission, however, we recommend to disconnect the drive shaft at the rear axle drive flange on any towing beyond a short tow to a nearby garage.

Jump Starting

If the battery is discharged the engine can be started with jumper cables (minimum lead cross section is 35 mm²) and the (12 V) battery of another vehicle. Proceed as follows:

- Turn key to steering lock position "0".
- Run engine of jumper vehicle at high idle.
- First connect jumper cables to the positive battery terminals and then to the negative terminals.

- Start engine as normal.
- After the engine has started, first remove jumper cables from the negative battery terminals and then from the positive terminals.

Instructions:

A discharged battery can freeze at approx. $-10^{\circ}\text{C} / +14^{\circ}\text{F}$. In all cases it must be thawed out before jumper leads are used.

Never lean over batteries while jump starting, you might get burned.

Unlocking of the Filler Flap

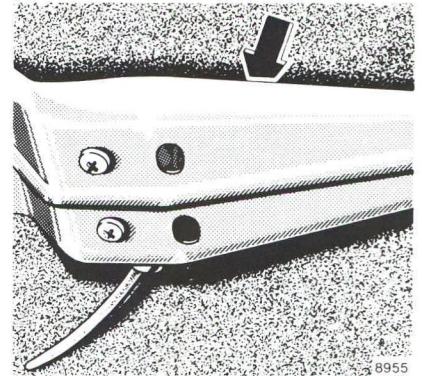

If the filler flap cannot be opened when the master lock system is unlocked, withdraw the link of the vacuum element (on RH side in trunk).

Technical Data
Fuels Coolants
Lubricants etc.



Identification Plates

When ordering spare parts, please quote chassis and engine numbers.

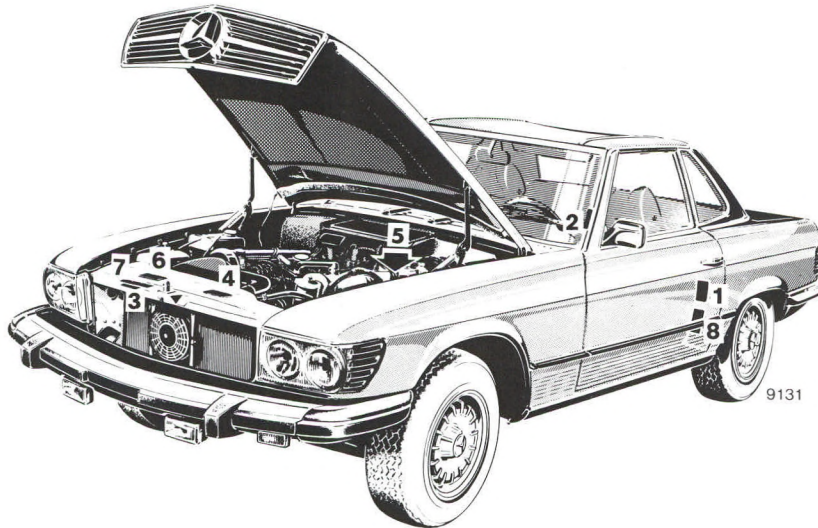

- 1 Certification Tag (left door pillar)
- 2 Identification Tag (left window post)

- 3 Chassis No.
- 4 Body No. and Paintwork No.
- 5 Engine No.

- 6 Information Tag
California version
Vacuum line routing for
emission control system
- 7 Emission Control Tag
- 8 Emission Control Tag
Catalyst Information

Vehicle Data Cards

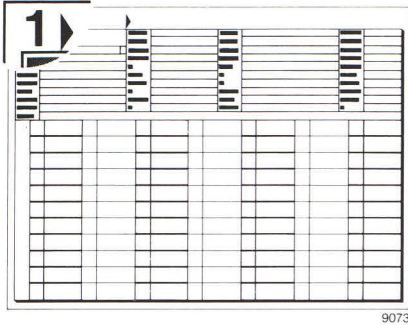

The vehicle data cards bear all the important data relating to your vehicle.

Data card No. 1 bears the key number and should on no account be left in the vehicle. Submit this card to your MERCEDES-BENZ service station to request a replacement key in case of loss.

Data card No. 2 bears no key data and is kept in the maintenance booklet. Presenting this card to the service station will facilitate the processing of the order.

Warranty Coverage

Your car is covered under the terms of the “warranties” printed in the owner’s service and warranty policy booklet and your dealer will exchange or repair any defective parts in accordance with the terms of the following warranties:

1. New vehicle limited warranty
2. Emission systems warranty
3. Emission performance warranty
4. California emission control systems warranty (state of California only unless purchased optionally for diesel models)

Loss of owner’s service and warranty policy

Should you lose your owner’s service and warranty policy booklet, have your local MB dealer arrange for a replacement. It will be mailed to you.

Technical Data

Type 380 SL (107 045)

Engine

Engine 116
Mode of operation 4-stroke engine,
gasoline injection
No. of cylinders 8
Bore 88.0 mm/3.46 in
Stroke 78.9 mm/3.10 in
Total piston displacement 3839 cm³/234.3 in³
Compression ratio 8.3
Output according to SAE 115 net-kW/4750 rpm/
155 net-bhp/4750 rpm
Firing order 1-5-4-8-6-3-7-2

V-belts:

Water pump – fan – power steering pump
2 V-belts 9.5 x 1100 mm
Alternator 9.5 x 990 mm
Air conditioning 12.5 x 920 mm
Air pump 9.5 x 750 mm

Transmission

Design Automatic four-speed
torque-converter transmission

Steering System

Design Power steering

Electrical System

Alternator 14 V/70 A
Starter motor 12 V/1.5 kW
Battery 12 V/88 Ah
Spark plugs see "last page"

Bulbs	12 V
High and low beams	Sealed beam/Halogen insert No. 1 and 2
Fog lamps	H 3
Turn signal, clearance and standing lamps, front	21/5 W/32/3 cp
Side marker lamps, front	4 W/2 cp
Side marker lamps, rear	5 W festoon lamp
Turn signal lamps, rear	21 W/32 cp
Tail and standing lamps, rear	10 W festoon lamp
Stop lamps	21 W/32 cp
Backup lamps	21 W/32 cp
License plate lamps	5 W festoon lamp
Footwell lamps	10 W festoon lamp
Dome lamps	5 W festoon lamp
Glove compartment lamp	5 W festoon lamp
Trunk lamp	5 W/3 cp

Weights See certification tag

Main Dimensions

Overall vehicle length	4630 mm/182.3 in
Overall vehicle width	1790 mm/ 70.5 in
Overall height (ready for driving), Roadster	1300 mm/ 51.2 in
Hardtop	1290 mm/ 50.8 in
Wheel base	2460 mm/ 96.9 in
Track, front	1452 mm/ 57.2 in
Track, rear	1440 mm/ 56.7 in

Rims – Tires

Rims	6½ J × 14 H 2
Summer tires:	
Radial-ply tires	205/70 HR 14
Winter tires:	
Radial-ply tires	205/70 SR 14 M + S

Fuels Coolants Lubricants etc. Capacities

Vehicle components and their respective lubricants must match.

Therefore use only brands tested and recommended by us.

Enquire at your MERCEDES-BENZ service station.

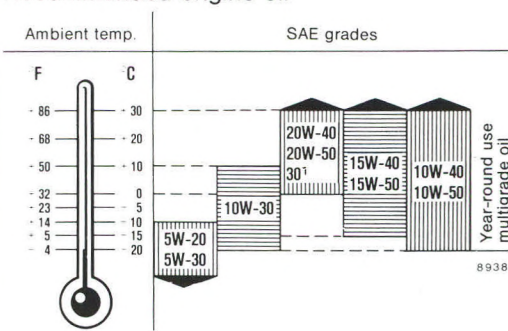
	Capacity	Fuels, coolants, lubricants, etc.
<p>Total oil capacity in case of engine oil and filter change</p>	<p>8.0 l/8.5 US qt</p>	<p>Recommended engine oil</p>  <p>Ambient temp. SAE grades</p> <p>F C</p> <p>86 - 30 68 - 20 50 - 10 32 - 0 23 - 5 14 - 10 5 - 15 -4 - 20</p> <p>5W-20 5W-30 10W-30 20W-40 20W-50 30¹ 15W-40 15W-50 10W-40 10W-50</p> <p>Year-round use multigrade oil</p> <p>8938</p> <p>¹ SAE 40 may be used if ambient temperatures constantly exceed +30° C/+86° F.</p>
<p>Automatic transmission</p>	<p>Initial fill: 7.3 l/7.7 US qt Fluid change: 6.2 l/6.5 US qt</p>	<p>Automatic transmission fluid (ATF)</p>

Fuels Coolants Lubricants etc. Capacities

	Capacity	Fuels, coolants, lubricants, etc.
Rear axle	1.3 l/1.3 US qt	Hypoid gear oil SAE 90, 85 W 90
Accelerator control linkage		Hydraulic fluid
Power steering	1.4 l/1.5 US qt	Automatic transmission fluid (ATF)
Front wheel hubs	approx. 70 g each/2.5 oz. each	Multipurpose grease
Grease nipples		Multipurpose or lubrication grease
Door locks		Special grease
Battery terminals		Bosch special grease
Brake reservoir	approx. 0.5 l/0.5 US qt	Brake fluid
Windshield washer system	approximately 5.0 l/5.3 US qt	Water plus windshield detergent
Fuel tank including a reserve of	approximately 85 l/22.5 US gal approximately 11.5 l/3.0 US gal	Unleaded gasoline: Average Octane of Research and Motor 87 (RON of 91)
Cooling system	12.5 l/13.2 US qt	Coolant

Engine Oils

Engine oils are specifically tested for their suitability in our engines. Therefore, use only engine oils recommended by us. Information on recommended brands is available at any MERCEDES-BENZ service station.

A new or reconditioned engine is filled with an initial operation oil in

the factory or in a MERCEDES-BENZ service station. This oil is specially developed for the specific operating conditions during the first 1300–1600 km/800–1000 miles.

A recommended engine oil may be used for topping up if the oil level drops to the dipstick minimum mark prior to the first service 1300–1600 km/800–1000 miles.

Brake Fluid

Brake fluid should be changed once a year, preferably in spring. Only use brake fluid recommended by us. For further information, refer to “Safe Driving”.

Coolants

The coolant is a mixture of water and antifreeze. In production, the cooling system is filled with an antifreeze-water mixture offering protection to approx. $-30^{\circ}\text{C}/-22^{\circ}\text{F}$. The red mark on the temperature gauge in the instrument cluster is matched to this antifreeze-water mixture (approx. boiling point $125^{\circ}\text{C}/257^{\circ}\text{F}$). The protection against corrosion is also ensured by this mixture making it unnecessary to add a corrosion inhibitor.

The coolant remains in the cooling system all year long and must be renewed after 3 years at the latest.

If coolant is lost, replace missing quantity with water (potable water quality) plus antifreeze of a recommended brand.

For reasons of corrosion inhibition the minimum proportion of antifreeze must be 34%, which gives antifreeze protection down to $-20^{\circ}\text{C}/-4^{\circ}\text{F}$.

If antifreeze is not available, add a corrosion inhibitor to the cooling water to ensure proper protection against corrosion. To treat the cooling water, do not use more than 1% (10 cm³/l) of a recommended corrosion inhibitor.

Without antifreeze in the cooling system, the water already starts boiling at approx. $118^{\circ}\text{C}/224^{\circ}\text{F}$, which means that the pointer of the temperature gauge in the instrument cluster may still be below the red mark.

Antifreeze

Your vehicle contains a number of aluminum parts. The use of aluminum components in motor vehicle engines necessitates that antifreeze/coolant used in such engines be specifically formulated to protect the aluminum parts. (Failure to use such antifreeze/coolant may result in a significantly shortened service life.)

While there may be a number of antifreeze/coolants available which will provide the required protection, all such products have not been tested for MERCEDES-BENZ vehicles. The following products, however, are deemed suitable for use in your car: MERCEDES-BENZ Antifreeze and Summer Coolant.

Prior to the onset of the cold season, check the coolant for its resistance to cold. Repeat this check during the cold spell. Regular testing of the antifreeze concentration is carried out only at each MERCEDES-BENZ maintenance service.

Protects up to	Antifreeze
-20°C -4°F	4.50 l/4.7 US qt
-30°C -22°F	5.50 l/5.8 US qt
-40°C -40°F	6.50 l/6.9 US qt

Service Literature

Customers who are interested in ordering service literature for their vehicles are advised to contact our subsidiaries in the U.S. or Canada at the following addresses.

for U.S.A.: Mercedes-Benz of N.A. Inc.
One Mercedes Drive
P. O. Box 350
Montvale, New Jersey 07645
Att: Technical Publications
Tel: (201) 573-0600

for Canada: Mercedes-Benz of Canada
849 Eglinton Ave., East
Toronto 17, Ont., Canada
Att: Service Department
Tel: 416-425-3550

The above companies will be happy to handle any such requests from customers.

We consider this to be the best way to obtain accurate information for your vehicle.

Reprinted in U.S.A.

We reserve the right to modify the technical details of the vehicle as given in the data and illustrations of this Owner's Manual (s.e.e.o.). Reprinting, translation and copying, even of excerpts, is not permitted without our prior authorization in writing.

ZKD VII.81.8. Ru.

- **Fuel:** Unleaded gasoline: Average Octane of Research and Motor 87 (RON of 91). Fuel tank capacity approx. 85 l/22.5 US gal, this includes a approx. 11.5 l/3 US gal reserve. Only fill fuel tank until the filler nozzle unit cuts out – do not over fill.
- **Engine Oil:** Check engine oil level regularly and prior to every long trip. See page 59. Quantity differential between upper and lower dipstick marking level: 2.0 l/2.1 US qt. Year-round multigrade-oils 10 W-40/10 W-50/15 W-40/15 W-50. For further information, refer to page 74.
- **Automatic Transmission:** Automatic transmission fluid (ATF). For level checks and replenishment, refer to page 61.
- **Coolant:** For normal replenishment, use water (potable water quality). For further information (e. g. antifreeze), refer to page 77.
- **Bulbs:** High and low beams: Sealed beam/Halogen insert No. 1 and 2, turn signal, clearance and standing lamps, front 21/5 W/32/3 cp, turn signal lamps, rear 21 W/32 cp, tail and standing lamps, rear 10 W festoon lamp, stop lamps 21 W/32 cp. For further information, refer to "Technical Data".
- **Spark Plugs:** Bosch W9 D, Beru 14-9 D, Champion N 12 Y.

- **Tire Pressure:** Cold tires:

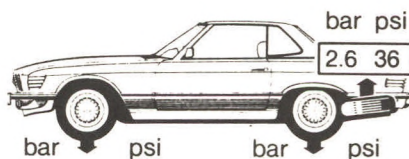

Warm tires:
 Pressure may rise by up to + 0.5 bar/+ 8 psi.
 Never release any air!

Summer tires:
Winter tires:

2.2 ¹	32 ¹	2.5 ¹	36 ¹
2.2	32	2.5	36

¹ For driving up to 175 km/h/110 mph
 - 0.2 bar/- 4 psi



Mercedes-Benz
service

Daimler-Benz AG Stuttgart-Untertuerkheim Zentralkundendienst
107 584 93 96 Bestell-Nr. 6550529913 USA-Ausgabe A 1982

