

01-310 Complete removal and installation of oil pan

Oil capacity in liters





Oil dipstick color code	wine red, pink brown ¹⁾	yellow-green
Oil pan	6	5.5
Oil filter		0.5
Air oil cooler	Model 107, 114, 116	0.7
	Model 123, 126	0.40

1) (USA) model year 1975/76

Tightening torques

	Nm
Oil drain plug on oil pan	40
Oil drain plug on air oil cooler	35
Filter lower section mounting bolt	45
Oil pan lower section to upper section	11

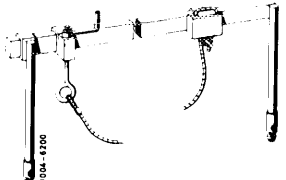
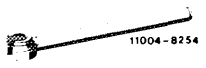
Special tools

Stud/ring wrench 13 x 14 mm		117 589 02 07 00
Stud wrench 5 mm, 300 mm long		116 589 02 07 00
Stud wrench 6 mm, 440 mm long		116 589 03 07 00
Engine support		107 589 02 61 00
Knocking-in tool for oil dipstick guide tube		117 589 00 31 00
Knocking-out mandrel 9 mm dia		110 589 02 15 00

Conventional tool

Engine hoist (Motordirigent) size 1.5	e.g. made by Bäcker, D-5630 Remscheid, order no. 3178
---------------------------------------	---

Self-made tools

Gauges for cutting-off radial sealing rings

Radial sealing ring graphite-grey

Part no. 000 997 65 41

$a = 1 \text{ mm}$

Radial sealing ring yellow-brown

$a = 0.5 \text{ mm}$

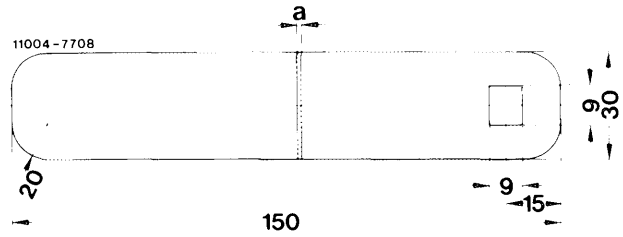

Note

The modified oil pan (1) is installed on models 107, 116 and 123 since October 1979 and model 126 since begin of series.

For this purpose, the rear 3 fastening threads on cylinder crankcase have been changed on both sides from M 6 to M 8 mm.

Begin of series: October 1979

Model	Engine	Engine end no.		chassis end no.
		manual transm.	automatic transm.	
107.022				007709
107.042	110.986	003225	007317	006965
116.020	110.922	040571	067591	120830
116.020	110.932	010337	002781	
116.024/025	110.985	014120	070947	152618
123.030	110.923	014163	017466	028051
123.033	110.984	020182	068009	065415
123.050	110.923	014163	017466	003470
123.053	110.984	020182	068009	017451
123.093				004597

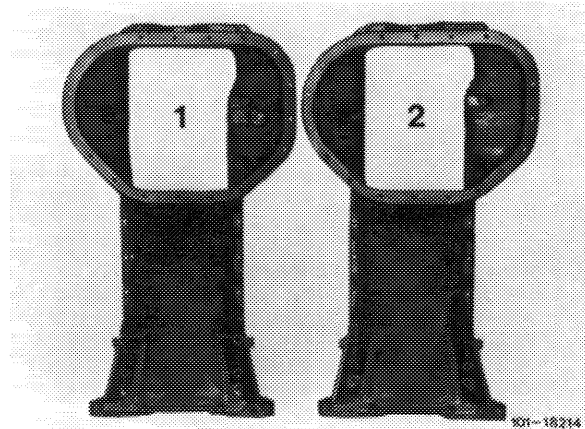

This modified oil pan is screwed to cylinder crankcase at the rear with 6 screws M 8 x 95 mm, formerly 4 screws M 6 x 40 mm and 2 screws M 6 x 25 mm.

On model 126 the modified oil pan is screwed to cylinder crankcase together with supporting tray (arrow) by means of 6 screws M 8 x 110 mm.

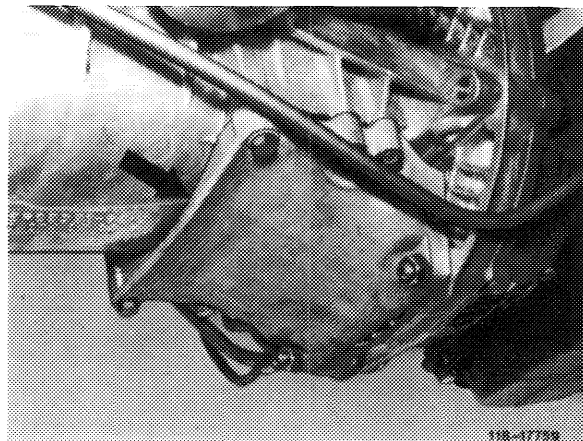

If a modified oil pan is installed in the course of repairs, the respective threaded bores in cylinder crankcase should be enlarged from M 6 to M 8 mm.

In the event of repairs, use radial sealing ring 000 997 90 41 (yellow-brown) with a projection of 0.5 mm on both sides, except when a new or newly ground crankshaft with new crankshaft bearings is installed. In such a case, use radial sealing ring 000 997 69 41 (graphite-grey) with a projection of 1 mm on both sides. This will protect the rear bearing journal of crankshaft against being overheated under influence of a low crankshaft bearing play and excessive pressure against yellow-brown radial sealing ring.

Removal

Model 107

- 1 Remove front axle (33–100).
- 2 Detach oil return pipe at cylinder head and pull off at oil pan.
- 3 Detach oil dipstick guide tube at cylinder head.
- 4 Detach steering rod at one side.
- 5 Detach alternator holder strut at oil pan.
- 6 Remove oil pan downward.

Note: Hold engine with engine support when working underneath engine.

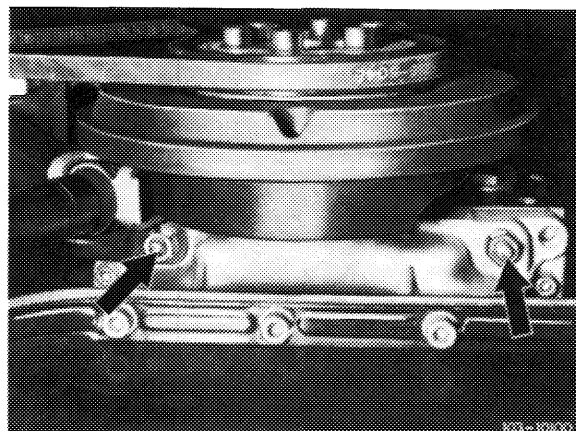

Model 114

1 Remove front axle (33–100).

2 Remove exhaust gas recirculation line (arrows) for USA models.

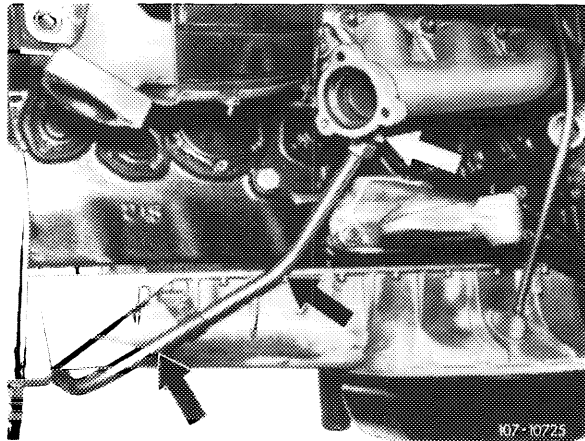

3 Remove oil lines for automatic transmission.

4 Detach oil dipstick guide tube at cylinder head.

5 Pull oil return line (1) off of oil pan (18–030).

6 Drain engine oil.

7 Remove oil pan.

Note: Hold engine with engine support while working underneath engine.

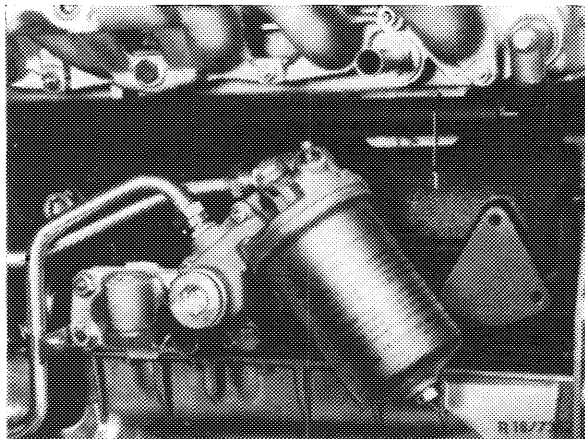

Model 116

1 Remove radiator.

2 Remove vibration damper (03–340).

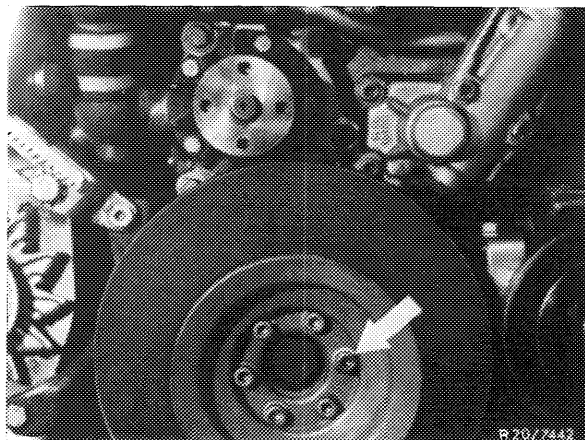

3 Detach control shaft (07.2-442).

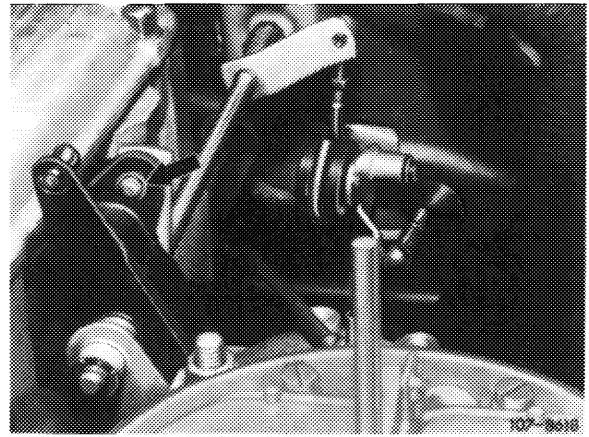

4 Detach both front engine mounts and engine dampers.

5 Pull oil return line off of oil pan (18-030).

6 Drain engine oil.

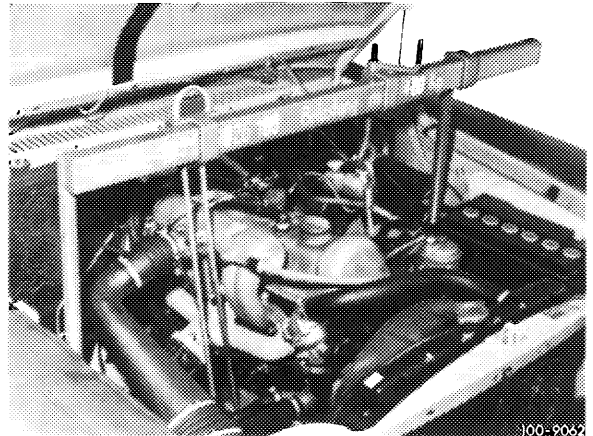

7 Remove oil pan lower section and oil pump.
Remove fuel pump of carburetor engines.

8 Remove oil lines for automatic transmission.

9 Detach oil dipstick guide tube at cylinder head
and drive it out from below with a 7.5 mm dia.
mandrel.

Knock-out oil guide tube for drawing off oil with
knocking-out mandrel 9 mm.

USA version

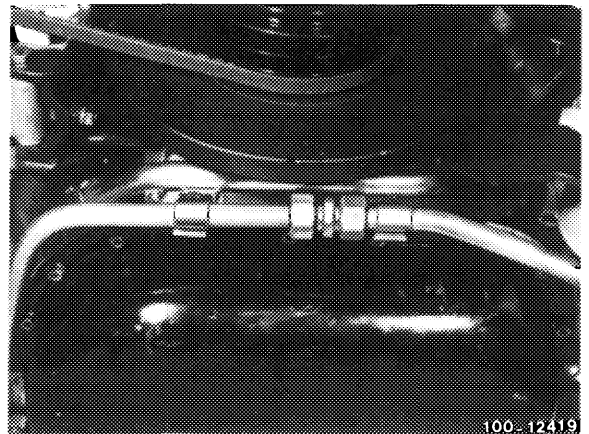

10 Detach rear engine mount, lift engine and place
an approximately 40 mm thick piece of wood under-
neath.

11 Lift front of engine and place approximately
60 mm thick pieces of wood on both sides between
the engine carrier and engine mounts.

12 Detach oil pan and remove forward.

Model 123

- 1 Remove engine (01–030).
- 2 Remove oil filter complete with lines.

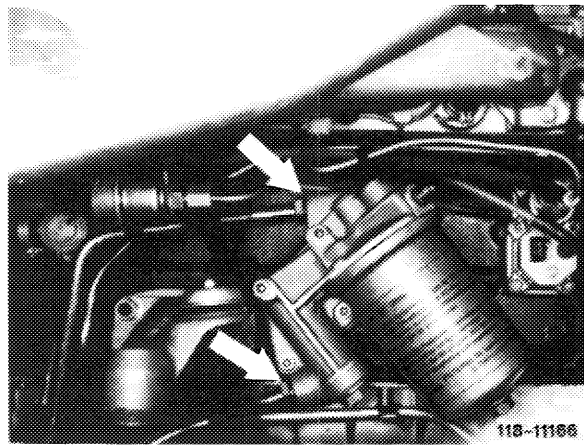

- 3 Pull-off oil return pipe (arrow).
- 4 Loosen strut for alternator bracket on oil pan.
- 5 Remove oil pan.

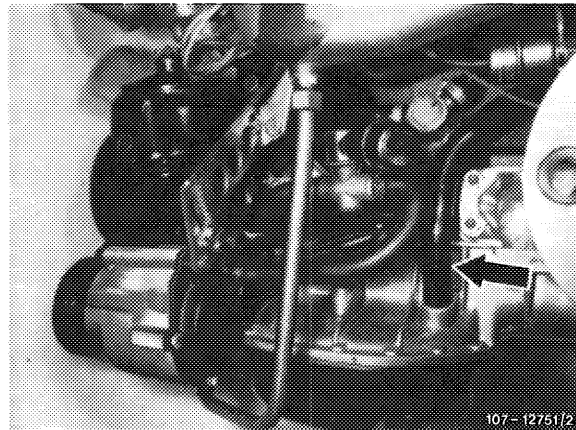

USA version

Model 126

- 1 Pull-off oil return line on oil pan.
- 2 Remove supporting tray.
- 3 Turn wheels completely to the left.
- 4 Unscrew cover plate.
- 5 Remove vibration damper (03–340).
- 6 Unscrew lower holding bracket of alternator.

7 Unscrew oil pan upper half to the extent that it is still held to crankcase by 2 screws.

8 Remove oil pan lower half.

9 Remove oil pump (3 screws).

10 Pull oil dipstick guide tube at top out of holder and knock out of oil pan upper half from below by means of a plastic hammer.

11 On vehicles with refrigerant compressor, remove lower strut.

12 Disconnect regulating linkage.

13 Unflange propeller shaft at transmission and push back.

14 Unscrew engine shock absorber below.

15 Unscrew screws for engine carrier on engine mount.

16 Suspend engine at the front and rear on engine removing eyes and lift until oil pan can be removed.

Installation, all models

- 1 Clean parting surface on cylinder crankcase and oil pan.
- 2 Renew rear radial sealing ring in oil pan and work in.

Note: Do not install radial sealing ring 000 997 90 41 (yellow-brown) in engines which are provided with a new or refinished crankshaft and new crankshaft bearings in the event of repairs.

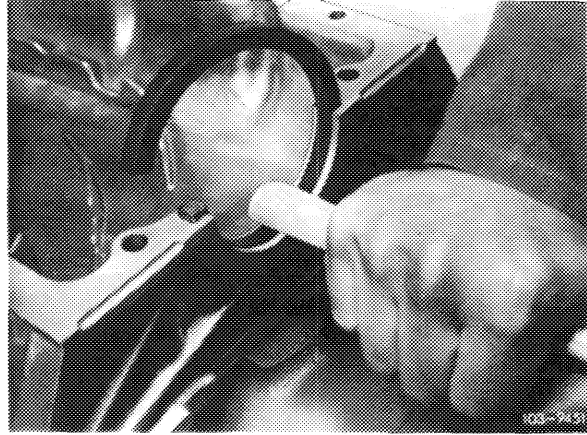

- 3 To arrive at an overlap, cut off radial sealing ring approx. 0.5 or 1.0 mm above parting surface. Use self-made gauge for this purpose.

Radial sealing ring, part no.	Dimension a (mm)
000 997 69 41 (graphite-grey)	1.0
000 997 90 41 (yellow-brown)	0.5

- 4 Provide radial sealing ring with engine oil.
- 5 Coat parting surface of oil pan with sealing compound.
- 6 Install oil pan and screw-on lightly at front and rear with 2 screws each.

Attention!

The oil pan should rest against or be screwed to intermediate flange prior to tightening fastening screws for crankcase.

- 7 For further installation proceed vice versa.

Attention!

Check regulating linkage for function.

