

03-340 Removal and installation of pulley, vibration damper and balancing disc

Tightening torques

	Nm
Screw M 18 x 1.5 x 45 on crankshaft	400-450
Screw M 8 x 65	35

Special tools

Socket 27 mm 1/2" square

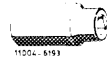

001 589 65 09 00

Torque wrench 150-500 Nm (15-50 kpm),
3/4" square



001 589 31 21 00

Detent



110 589 00 40 00 or

Detent



116 589 01 40 00

Puller for balancing disc

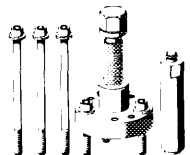

116 589 10 33 00

Note

The **vibration damper** can be replaced **without balancing**.

If the **balancing disc** is renewed, static **balancing** is required (03-344).

Since May 1974 a balancing disc with 3 cutouts for removing tensioning rail bearing bolt is installed.

- | | |
|-------------------------------|--------------------------|
| 1 Pulley | 8 Spacing ring |
| 2 Screw M 8 x 65 | 9 Crankshaft gear |
| 3 Disc | 10 Woodruff key |
| 4 Vibration damper 254 mm dia | 11 Crankshaft |
| 5 Cyl. pin 10h 8 x 18 | 12 Set pin 8 x 8 |
| 6 Balancing disc | 13 Cup spring |
| 7 Radial sealing ring | 14 Screw M 18 x 1.5 x 4! |

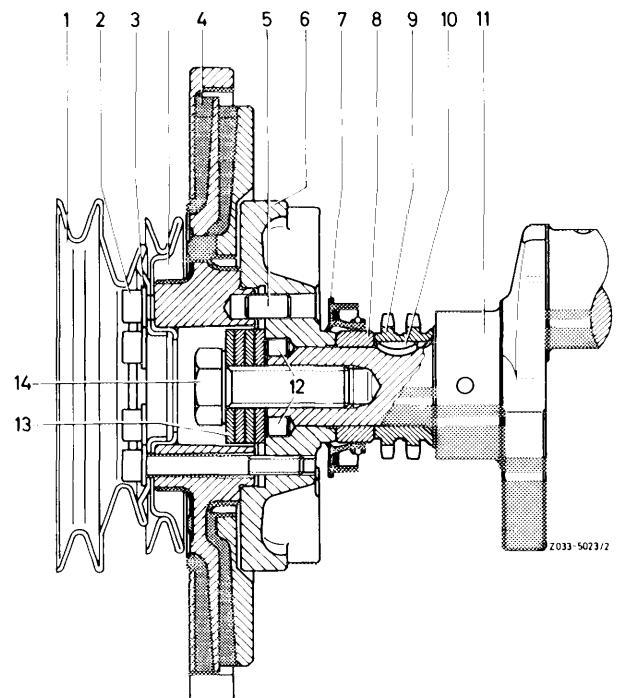

Attention!

For engines which have a "0/0" mark for BDC on the vibration damper besides TDC, the **TDC mark** in the vibration damper is **next to the pin**.

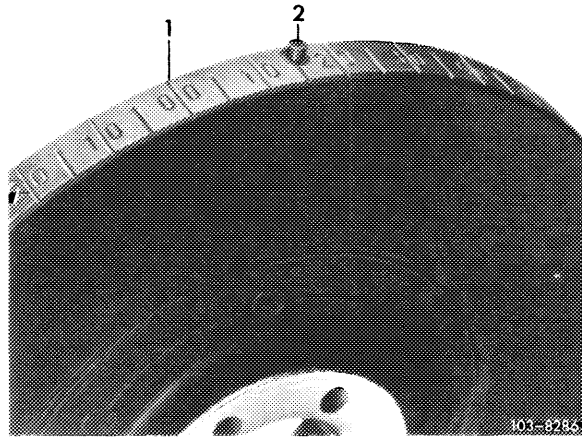

Removal

- 1 Remove radiator and fan.
- 2 Remove pulley and vibration damper.

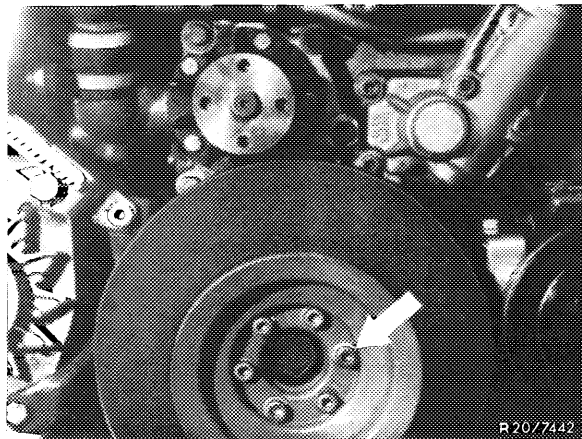

- 3 Counterhold crankshaft with holder.

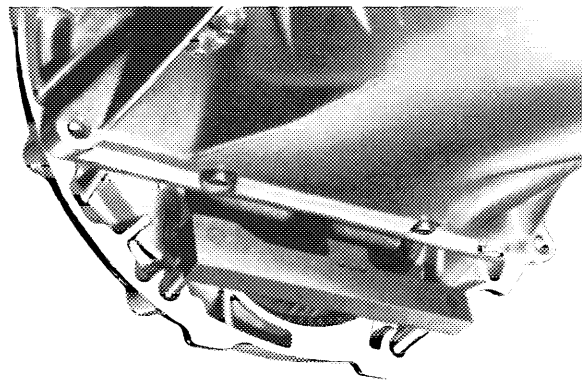

Holder 110 589 00 40 00

103-9243

Also remove starter of engines with a manual transmission.

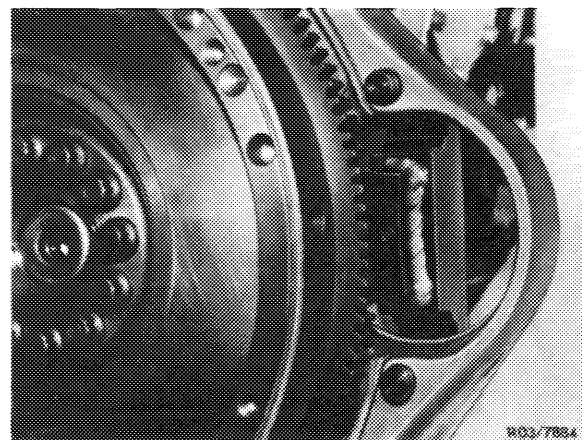

Holder 116 589 01 40 00

4 Remove bolt in crankshaft.

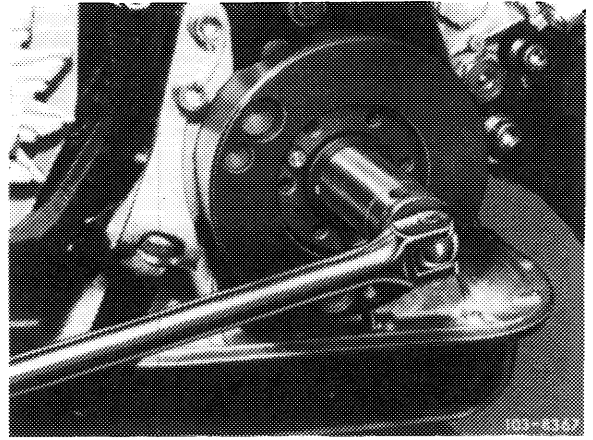

5 Mark balance disc and crankshaft together with a punch mark.

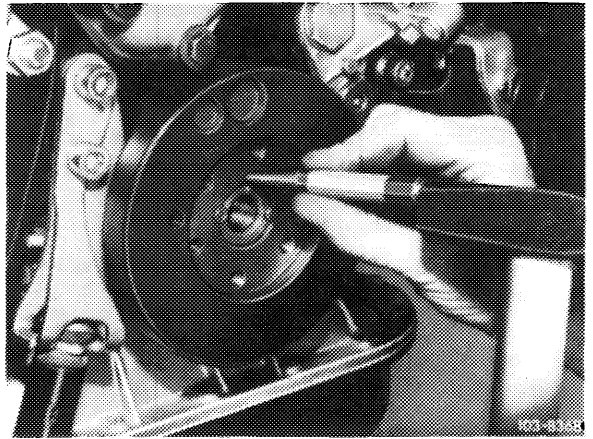

6 Pull off balance disc with an extractor.

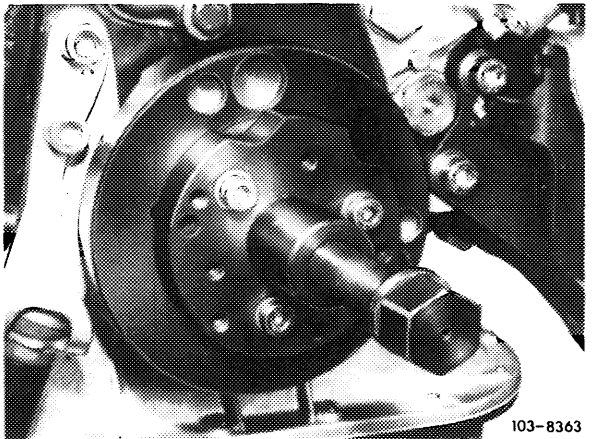

Installation

7 Install balance disc on crankshaft that bores for dowel pins align.

Note: The balance disc is located on the crankshaft by two **offset** dowel pins.

8 Pull balancing disc on crankshaft with screw M 18 x 1.5 x 45 and a cup spring.

9 Knock-in both set pins.

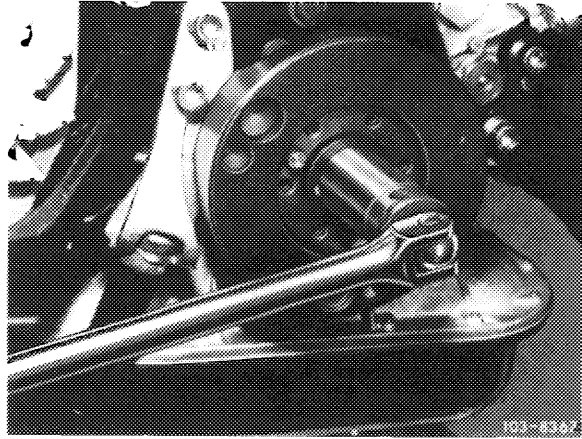

10 Mount four cup springs with convex face facing screw head.

11 Tighten screw on crankshaft to 400 Nm while applying counterhold to crankshaft by means of detent.

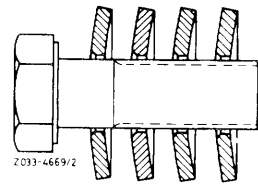

Note: Damaged threads M 18 x 1.5 in crankshaft journal at the front can be repaired by inserting a helicoil insert 0130 0184027.

12 Install vibration damper, pulley, viscofan and radiator.

Note: Take association of pulley on crankshaft for various engines 110 from the following list.

Pulley	Engine
110 155 00 15	110.921
	110.931
	110.981
	110.991

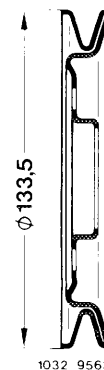

110 155 00 15

Pulley	Engine
110 466 01 15	110.921*
	110.931*
	110.922 version 1
	110.032 version 1
	110.981*
	110.991*
	110.982
	110.992
	110.983
	110.993

* with special version power steering or air conditioning

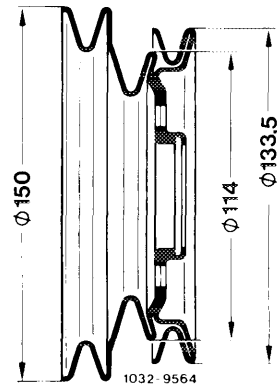

110 466 01 15

Pulley	Engine
123 032 00 04	110.922 version 2
	110.932 version 2
	110.923 version 1*
	110.924 version 1*
	110.984 version 1*
	110.985
	110.986
	110.987 version 1*
	110.994

* with 55 Ah alternator

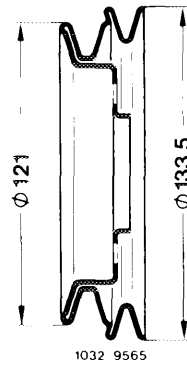

123 032 00 04

Pulley	Engine
123 032 01 04	110.922*
	110.932*
	110.923*
	110.924*
	110.984*
	110.985*
	110.986*
	110.987*
110.994*	

* with special version air conditioning or emission control

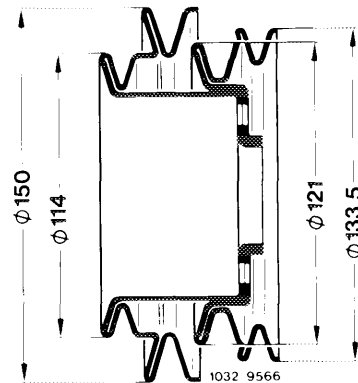

123 032 01 04

Pulley 110 032 08 04¹⁾

Introduction into series (J) August 1978

starting engine end no. starting chassis end no.

110.984-12-043 370 123.033-12-043 906

110.985-12-044 308 123.053-12-010 554

Introduction into series (S²⁾ and (USA) March 1980

starting engine end no. starting chassis end no.

110.984 -10-023 276 123.007²⁾
-12-076 809 123.033 019 600

110.985 -12-075 271 116.024-157 385

1) Together with 65 Ah alternator

2) (S) only

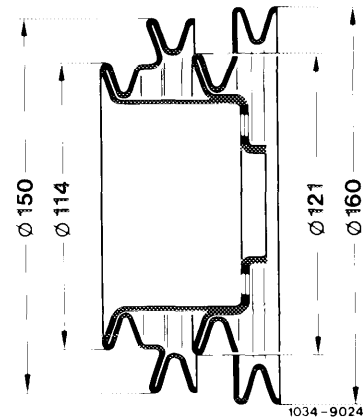

110 032 08 04

Pulley 110 032 09 04* (formerly 123 032 00 04)

Introduction into series March 1980

starting engine end no. starting chassis end no.

110.923	-10-014 965	123.030-029 250
	-12-018 195	123.050-003 705
110.924	-10-000 356	126.021-001 320
	-12-001 102	
110.984	-10-023 276	123.033-073 349
	-12-076 809	123.053-019 600
110.985	-12-075 271	126.024/025-157 385
110.987	-10-000 675	126.022/023-004 070
	-12-003 696	

* together with 65 Ah alternator

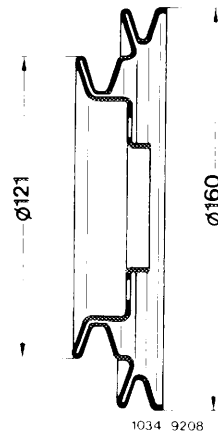

Pulleys, vibration damper and balancing disc

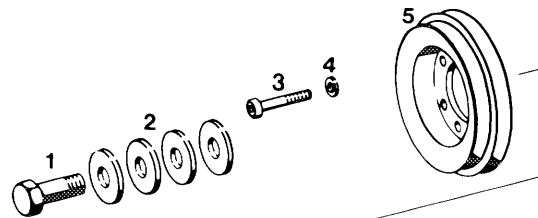

- 1 Screw M 18 x 1.5 x 45
- 2 Cup springs
- 3 6 screws M 8 x 65
- 4 6 washers 8.4
- 5 Pulley
- 6 Vibration damper 254 mm dia
- 7 Adjustment indicator
- 8 2 set pins 8 x 8
- 9 Cyl. pin 10h 8 x 18
- 10 Balancing disc
- 11 Radial sealing ring
- 12 Spacing ring
- 13 Crankshaft gear
- 14 Woodruff key

