

07.2–100 Adjusting idle speed

Identification: Information plate in national language on cross member in front of radiator or on cylinder head cover. Adjust engines according to data of respective emission control information plate.

Testing and adjusting values

National version	Idle speed 1/min	Idle speed emission value % CO
(J) up to 1976 (S) 1976	800–900	max. 1.5
(USA) 1973		max. 1.0 without air injection
(USA) 1974 Federal	750–900	up to 1.5
(USA) 1974 California	700–900	6–8 without air injection
(USA) 1975/76	800–900	max. 1.0 without air injection

Vacuum governor¹⁾

National version	Engine speed Vacuum hose pulled off 1/min		Engine speed Driving position engaged 1/min
	without TN choke	with TN choke	
(J) 1976	—	1700–1900	600–700
(S) 1976	—		
(USA) 1973/74	1200–1400		
(USA) 1975/76	—		

¹⁾ When engaging all auxiliary units, the engine should still run smoothly.

Special tools

Oil telethermometer



116 589 27 21 00

Digital tester

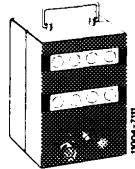

001 589 54 21 00

Connecting cable 6 m long

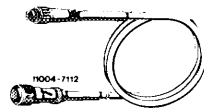

000 589 04 90 00

Intermediate plug (adaptor)

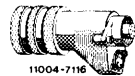

000 589 72 63 00

Trigger



000 589 71 63 00

Conventional tools

Rpm and CO measuring instrument

Note

Do not set idle speed on dynamometer when the engine is too hot, e.g. immediately after a fast drive or after measuring output. The air filter must be mounted.

Adjusting

1 Connect test instruments:

- digital tester or revolution counter
- CO measuring instrument
- oil telethermometer

2 Switch off air conditioning system or automatic climate control. Move selector lever into position "P".

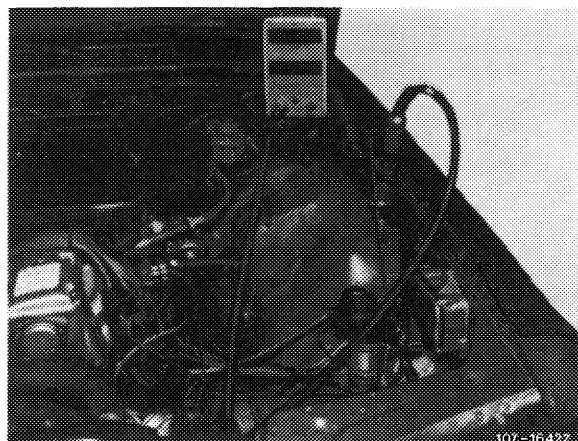

107-36427

3 Check whether on vehicles with cruise control (Tempomat) the Bowden wire rests **free of tension** against regulating lever. Adjust Bowden wire with adjusting nut (1), if required. For this purpose, run engine.

4 Set engine oil temperature to 60–80 °C.

5 Check intake system for leaks. For this purpose, spray all sealed points with Iso-Oktan DIN 51 756 or benzine. A changing engine speed or CO value indicates the presence of leaks.

Attention!

Do not use conventional fuel for spraying (unhealthy vapors). Pay attention to inflammability and do not spray on the red-hot parts or components of the ignition system.

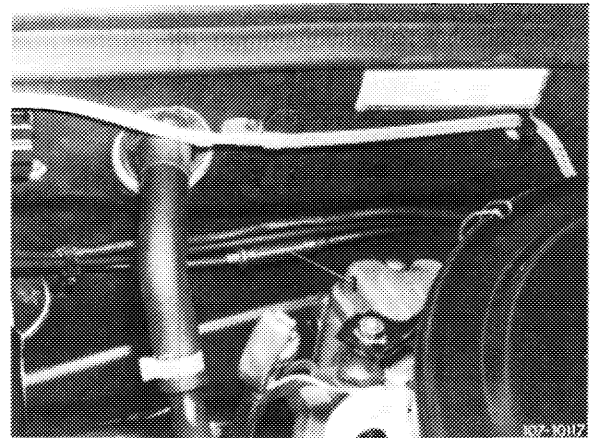
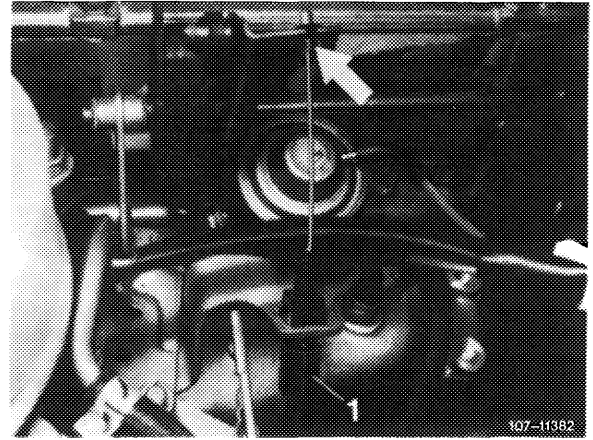

6 With the engine running, check whether throttle valve lever (3) rests against adjusting screw (68).

7 Check idle speed and adjust with adjusting screw (68), if required.

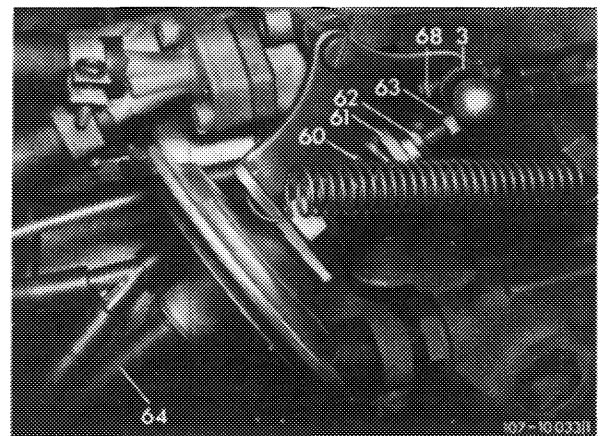

8 Check idle speed emission value **without air injection**. For this purpose, make air injection inoperative as follows (for **USA** 1973/74 nothing need be made inoperative):

Ⓝ 1976

Pull off **blue/purple** vacuum line at connecting point (arrow).

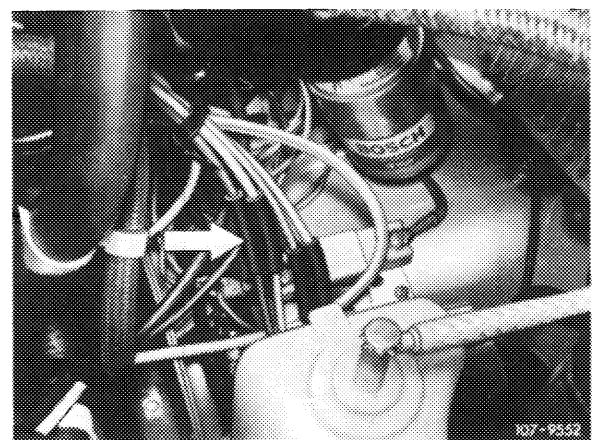

Ⓢ 1976, model 114

Pull rubber cap (arrow) from **blue/purple** vacuum line.

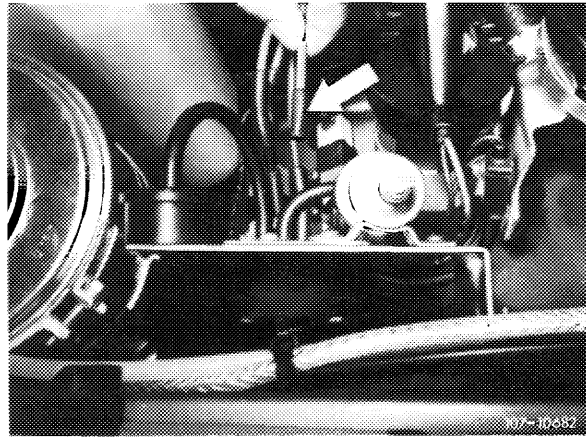

Ⓢ 1976, model 116

Pull rubber cap (arrow) from **blue/purple** vacuum line.

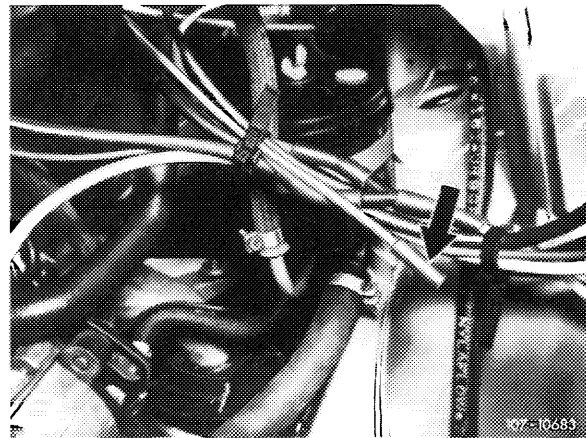

ⓊSA California 1974

Pull off **red** vacuum line at connecting point (arrow).

ⓊSA 1975/76

Pull off **blue/purple** vacuum line at connecting point (arrow).

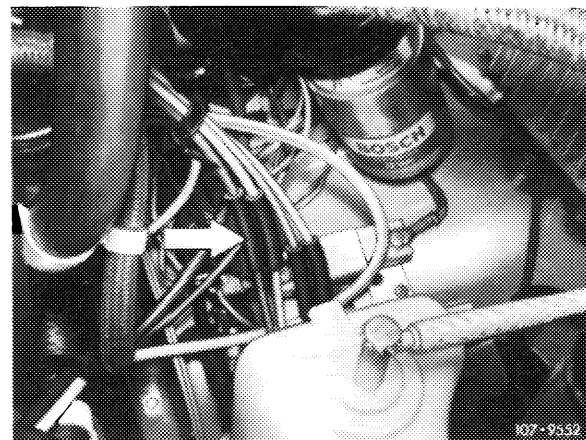

The exhaust gas for idle speed CO measurement on vehicles with catalyst, ⓐ 1976 and ⓊSA 1975/76, is drawn off in front of catalyst at check valve (arrow) of air injection.

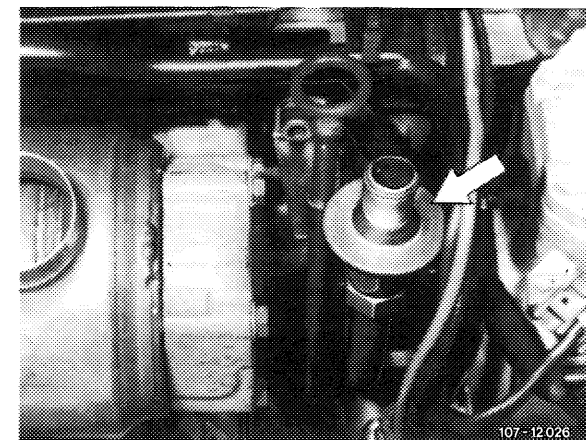

For measuring idle speed emissions, open valve plate of check valve by means of a self-made wire hook. Connect exhaust gas hose of CO measuring instrument to check valve.

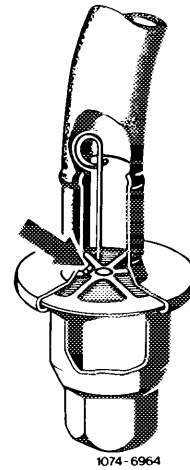

9 Adjust idle speed emission value **without air injection**. For this purpose, adjust both adjusting screws (arrows) uniformly.

Screwing out = richer
Screwing in = leaner

Accelerate for a short moment, check idle speed and idle speed emission value once again and readjust, if required.

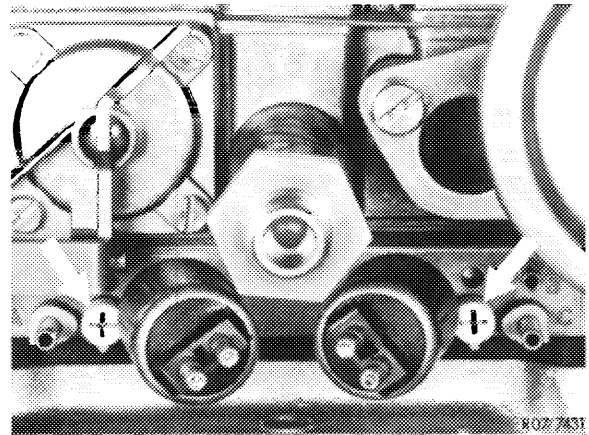

10 Reattach vacuum hose for air injection (air injection operating). The idle speed emission value should now be **below** the previously set value.

11 Adjust vacuum governor. Run engine, pull off vacuum hose (64), set to specified speed by means of an adjusting screw (63), attach vacuum hose.

Attention!

When loosening counternut, apply counterhold to diaphragm rod.

Engage driving position on automatic transmission, set to specified speed by means of adjusting nut (61). Turn power steering to full lock and engage air conditioning system, engine should still run smoothly. Readjust speed, if required.

