

## 05—212 Renewal of threaded bushing with valve adjusting screw

Valve clearance	with engine cold (approx. 20 °C)	with engine warm (60 °C ± 15 °C)
Intake	0.10 <sup>1)</sup>	0.15 <sup>1)</sup>
Exhaust	0.20	0.25

<sup>1)</sup> 0.05 mm higher during lasting outside temperatures below -20 °C.

Tightening torques	Nm
Nuts for cylinder head cover	15
Threaded bushing in cylinder head	80
Valve adjusting screw	20—40

### Special tools

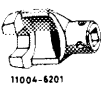
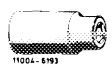
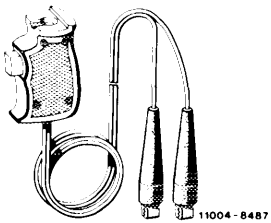
Pressure lever for valve spring		123 589 03 61 00
Valve adjusting wrench 17 mm, 1/2" square		110 589 00 01 00
Socket 27 mm, 1/2" square, for rotating engine		001 589 65 09 00
Contact handle for rotating engine (component of compression pressure recorder (compressometer) 001 589 46 21 00)		001 589 46 21 08

## Note

---

If the torque of the valve adjusting screw is below 20 Nm, renew valve adjusting screw (63) or threaded bushing (65) with valve adjusting screw (63).

- 57 Tensioning spring
- 58 Annular spring
- 60 Thrust piece
- 63 Valve adjusting screw
- 65 Threaded bushing

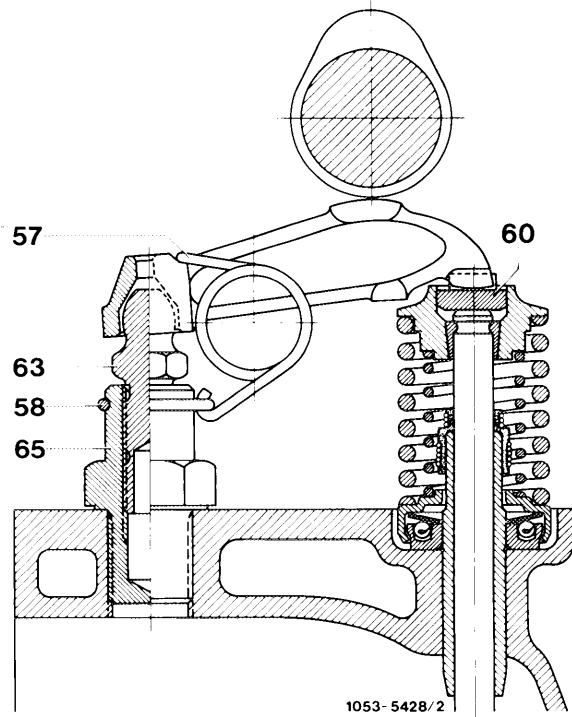

## Renewing

---

1 Remove cylinder head cover. For this purpose, on (AUS), (J), (S) and (USA) starting 1977, push out clamp assembly of fuel hoses on holder and push down fuel hoses with clamp assembly in forward direction over cylinder head cover.

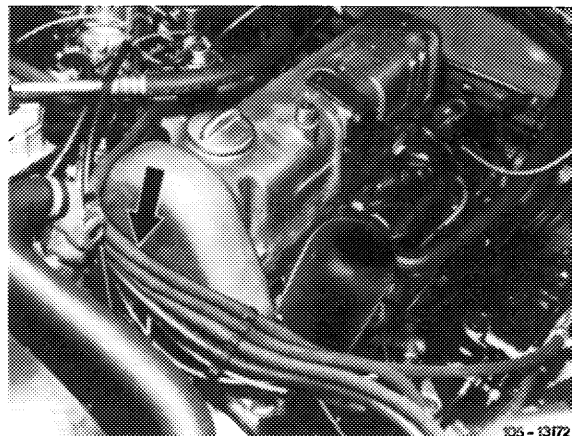
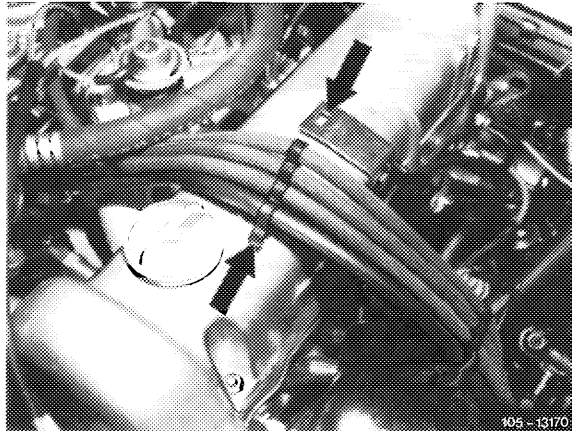

2 Remove rocker arm (05–230).

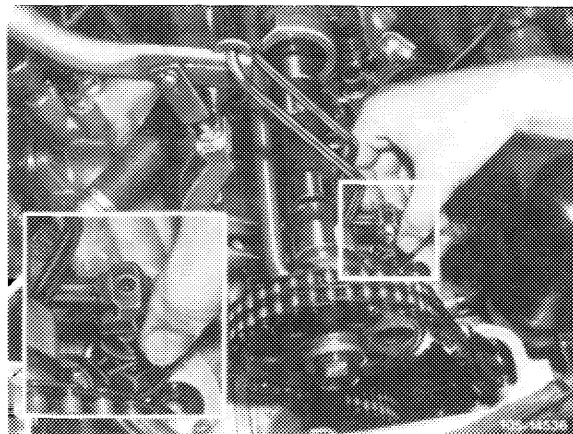

3 Pull off annular spring.

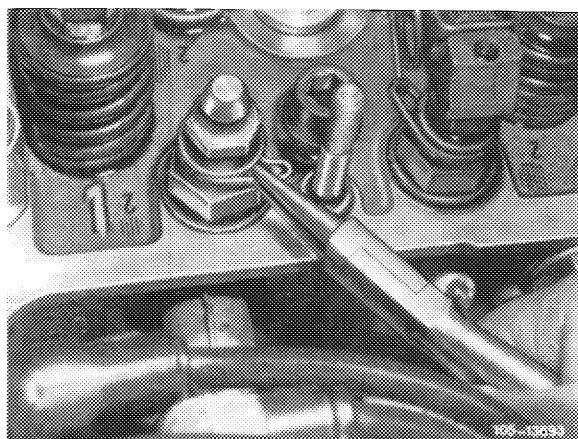

4 Unscrew threaded bushing with valve adjusting screw.

5 Coat threads of threaded bushing with tallow.

Screw-in threaded bushing with valve adjusting screw and tighten to 80 Nm.

**Attention!**

The threaded bushing should not cut shavings when screwed in.

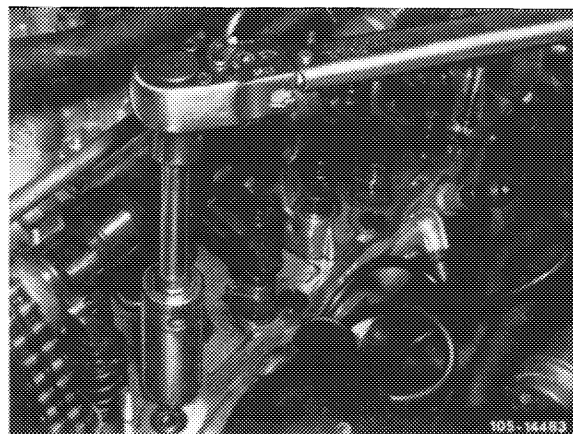

6 Insert annular spring.

7 Install rocker arm (05–230).

8 Adjust valve clearance (05–210).

