

Self-made tools

---

Pressing-off disc for impeller

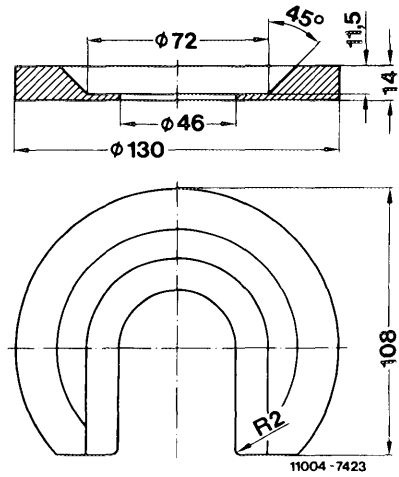

Pressing-in sleeve

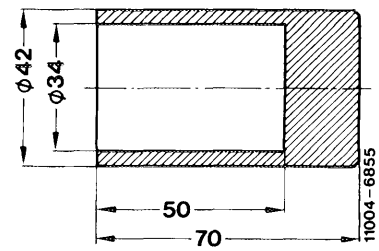

Disassembly

---

1 Press off impeller. For this purpose, place pressing-off disc between impeller and bearing housing.

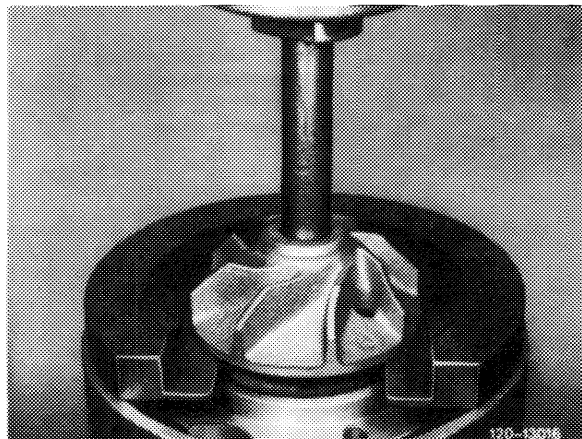

2 Apply light hammer blows at several points between bearing housing and sliding ring seal to cancel preload and force sliding ring seal out.

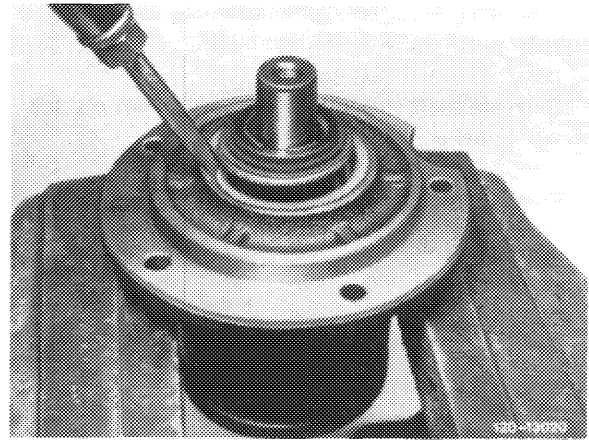

3 Force counter-ring out of impeller.

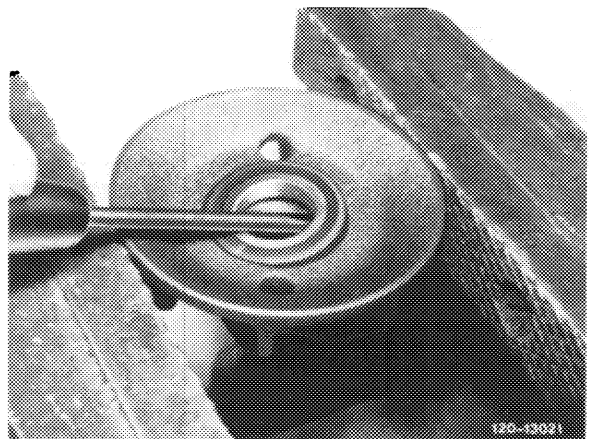

### Assembly

4 Slightly coat mounting bore of sliding ring seal in bearing housing with sealing compound (part No. 001 989 25 20) and press-in sliding ring seal by means of pressing-in sleeve or knock in.

#### Attention!

Support at bearing housing only and not a coolant pump shaft.

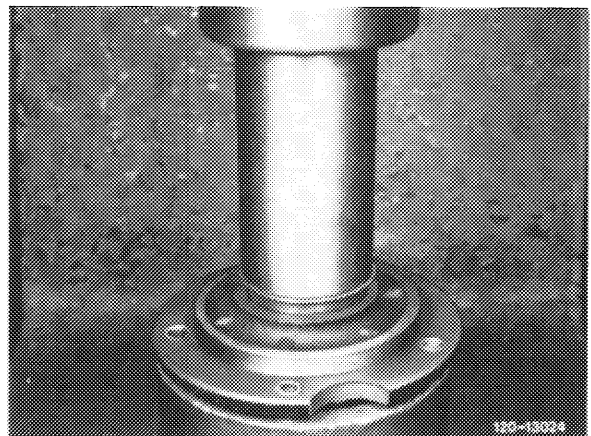

5 Coat sealing ring on counter-ring with brake cylinder paste and push with chamfered side (arrow) into thoroughly cleaned mounting bore of impeller.

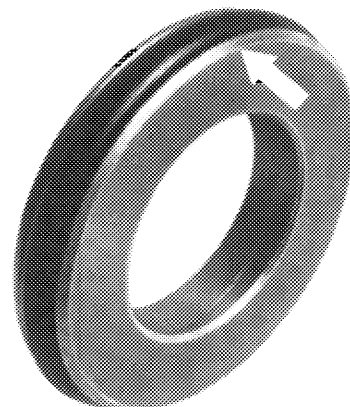

120 - 10863

6 Clean sealing surfaces of counter-ring and sliding ring seal dust-free with chamois cloth.

7 Degrease shaft stub of coolant pump shaft and the bore in impeller.

8 Press-on impeller flush with coolant pump shaft, while supporting coolant pump shaft.

