

35–350 Disassembly, assembly and adjustment of wheel carrier

Diagonal swing axle with starting torque compensation



Adjustment of wheel bearing

Wheel carrier of 1st version	Bearing pin dia. for inner tapered roller bearing		19.074
			19.065
Wheel carrier of 2nd version	End play in coupled semi-trailing arm	0.01	+ 0.03 – 0.01
	Bearing pin dia. for inner tapered roller bearing		19.050
	Tightening torque of self-locking hex nut	40 + 10 Nm	19.041

Lubricant/Grease quantity

Lubricant	Lubricant Longterm 1 from Dow Corning GmbH, Munich, or Olistamoly 1 from Optimol-Ölwerke GmbH, Munich		
Quantity each side		45 g	
Tightening torque			Nm
Hex bolt for attaching link to caliper carrier			25

Special tools

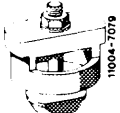
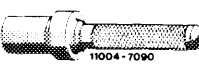
Clamp for semi-trailing arm		116 589 03 31 00
Puller for pulling cover of wheel carrier bearing out of coupled semi-trailing arm		116 589 06 33 00
Puller for pulling outer race of outer tapered roller bearing out of coupled semi-trailing arm		116 589 05 33 00
Punch for knocking outer race of inner tapered roller bearing out of coupled semi-trailer arm		116 589 04 15 00

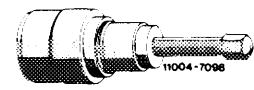
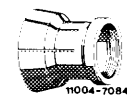
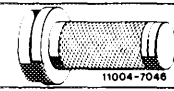
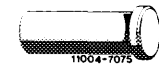
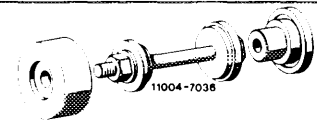
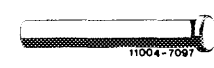
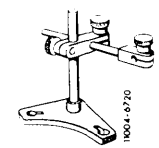
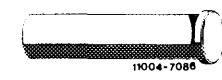
Puller for tapered roller bearing inner races (basic tool)		001 589 36 33 00
Collet for puller 001 589 36 33 00 for tapered roller bearing inner race on bearing pin of wheel carrier		000 589 01 34 00
Punch for protective ring on wheel carrier		116 589 03 15 00
Punch for inner race of outer tapered bearing on bearing pin of wheel carrier		116 589 02 15 00
Installer for tapered roller bearing outer race and radial sealing ring on coupled semi-trailing arm		107 589 00 43 00
Punch for inner race of inner tapered roller bearing on bearing pin of wheel carrier (for wheel carrier 1st version only).		116 589 06 15 00
Dial gauge holder (for wheel carrier 1st version only).		136 589 04 21 00
Punch for protective cap on coupled semi-trailing arm		116 589 07 15 00

Conventional tool

Two-arm puller for removing bearing pin out of coupled semi-trailing arm

e.g. made by Nexus, 5630 Remscheid
order No. 100 Gr. 2

Disassembly

- 1 Remove coupled semi-trailing arm (35–310).
- 2 Clamp coupled semi-trailing arm into vise by means of clamp (01).

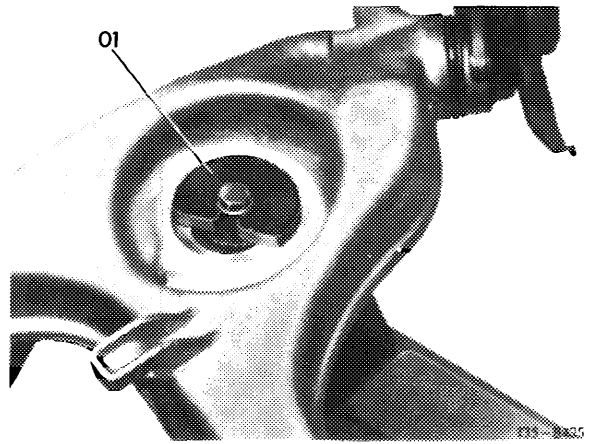

- 3 Remove caliper (1), brake disc and tightening brake (42–530).
- 4 Remove brake cable control (42–525).

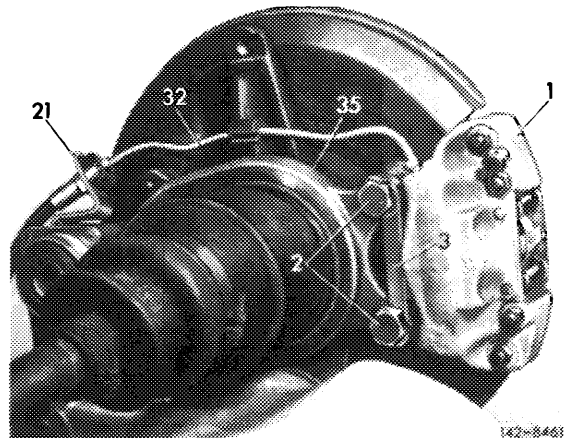

- 5 Pull cover of wheel carrier bearing out of coupled semi-trailing arm by means of puller.
- 6 Unscrew self-locking hex nut on bearing pin and remove together with washer.

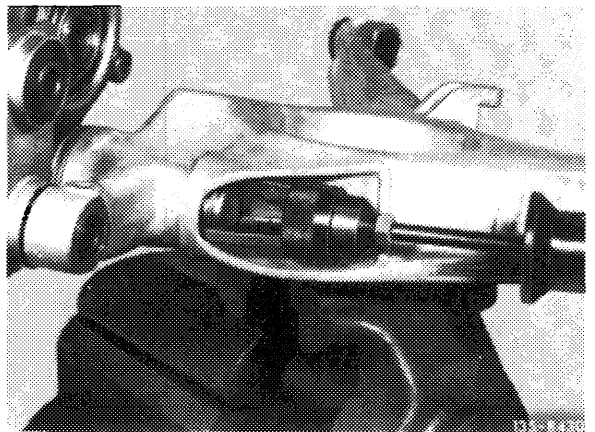

- 7 Unscrew caliper from link bolt.

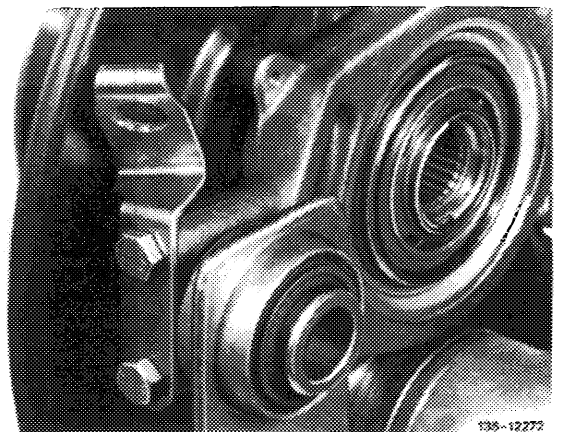

Note: Pulling wheel carrier out of coupled semi-trailing arm by means of a two-arm puller is required only on 1st version (up to June 1975).

On 2nd version of wheel carrier, pulling out of two-arm puller is no longer required, since the inner race of the inside tapered roller bearing is no longer installed as a press fit on bearing pin of wheel carrier.

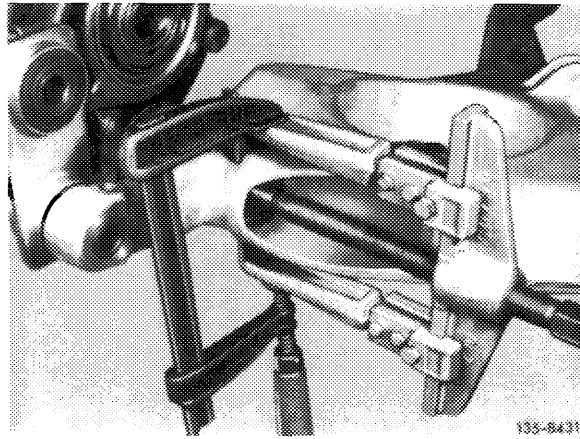

8 Push or pull bearing pin of wheel carrier out of coupled semi-trailing arm and remove together with tapered roller bearing inner race.

9 Knock radial sealing ring from coupled semi-trailing arm.

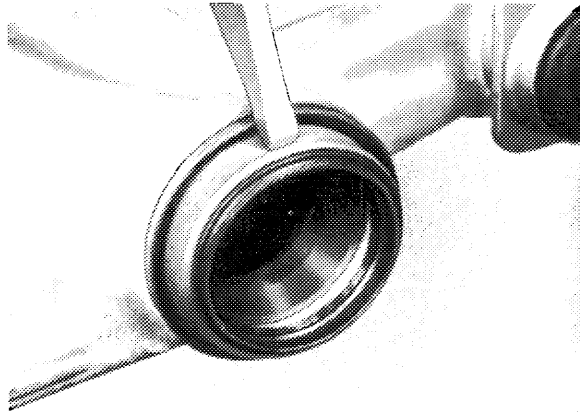

10 Pull outer race of outside tapered roller bearing out of coupled semi-trailing arm.

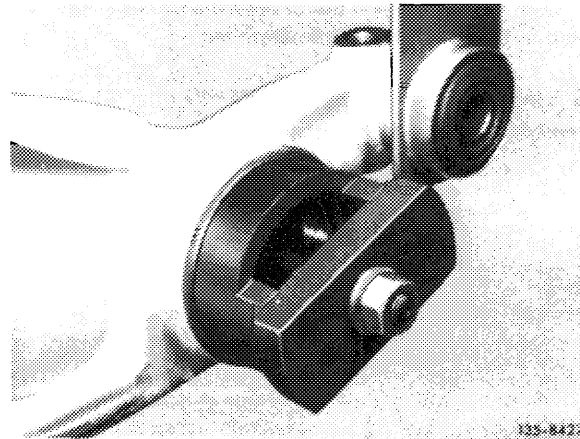

11 Knock outer race of inner tapered roller bearing out of coupled semi-trailing arm by means of punch.

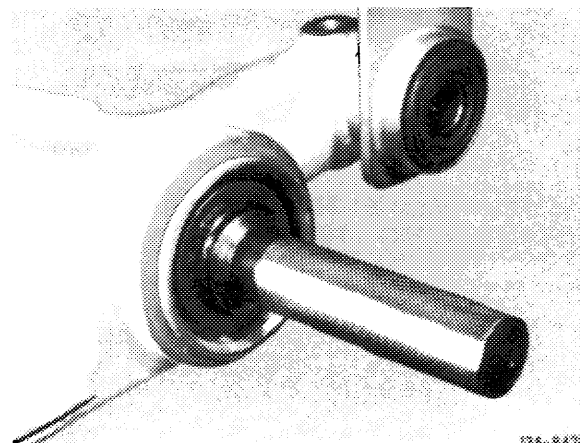

12 Knock protective ring from wheel carrier.

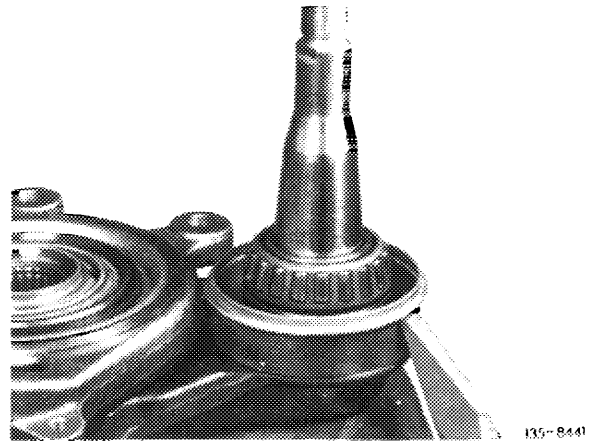

13 Pull inner race of outside tapered roller bearing from bearing pin by means of puller and collet.

14 Check all parts for re-use. Renew worn and damaged parts.

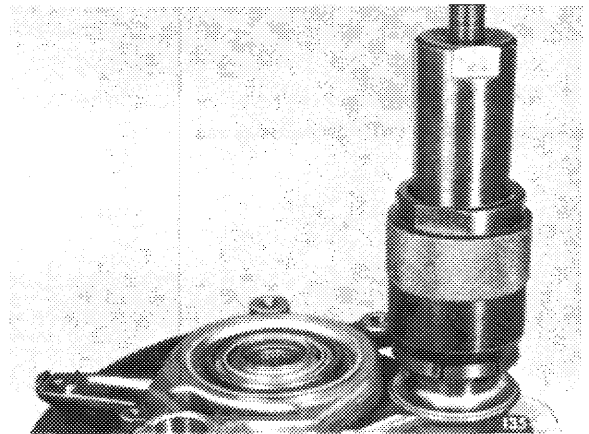

Assembly

15 Knock new protective ring on wheel carrier with punch.

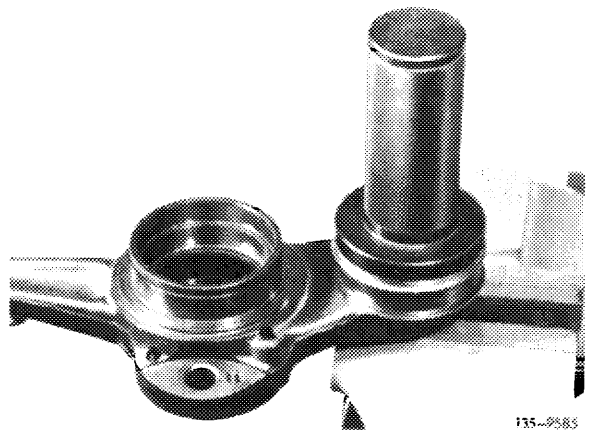

16 Knock inner race of outer tapered roller bearing on bearing pin with punch.

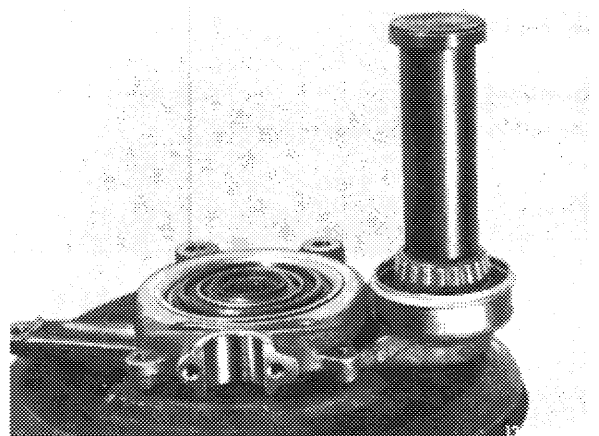

17 Install both bearing outer races into coupled semi-trailing arm with installer.

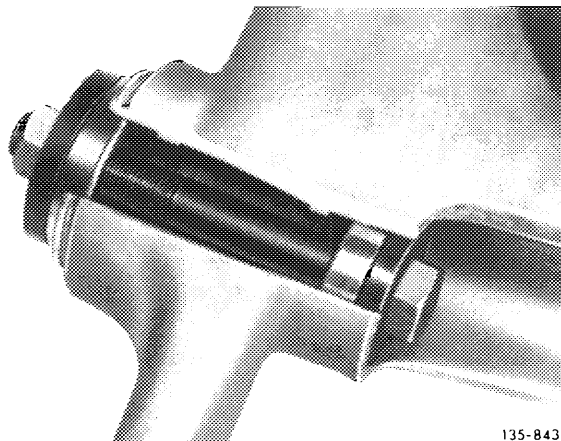

135-8432

18 Pull radial sealing ring on coupled semi-trailing arm with installer.

19 Fill cavity between bearing outer races in coupled semi-trailing arm with specified grease.

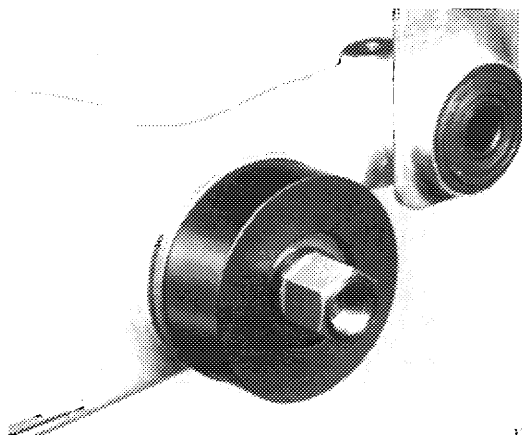

135-8429

20 Introduce bearing pin of wheel carrier into coupled semi-trailing arm.

21 Knock in inner race of inside tapered roller bearing by means of punch (01, required for 1st version only). On 2nd version, slip-on tapered roller bearing inner race.

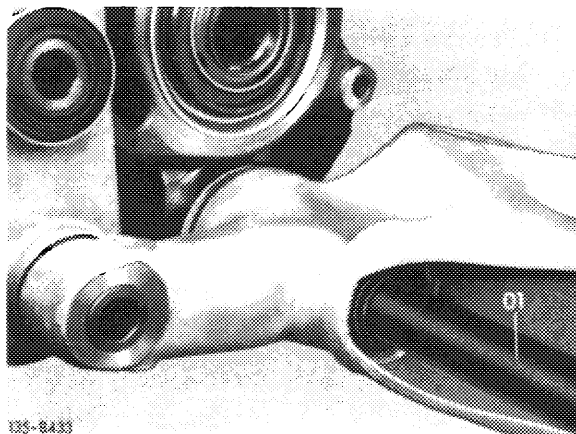

135-8433

22 Insert washer (96) and screw-on new self-locking hex nut (97).

Attention!

Use self-locking hex. nuts only once.

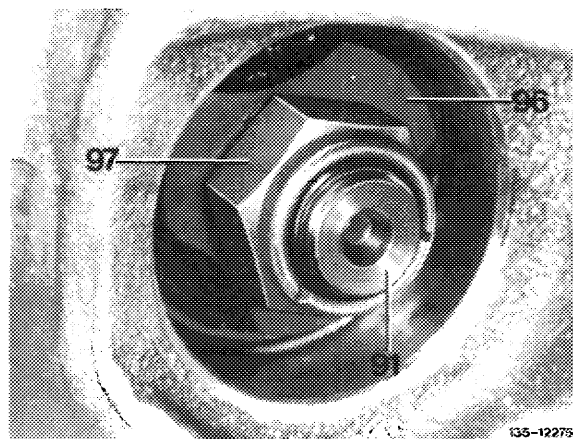

135-12275

Adjustment (wheel carrier 1st version)

23 Tighten self-locking hex nut to 40–50 Nm while simultaneously turning wheel carrier. Then turn self-locking hex nut back for approx. 1–2 turns and release preload by applying one blow each against inside and outside of bearing pin.

Note: Apply settling blow only in combination with a brass or aluminum mandrel.

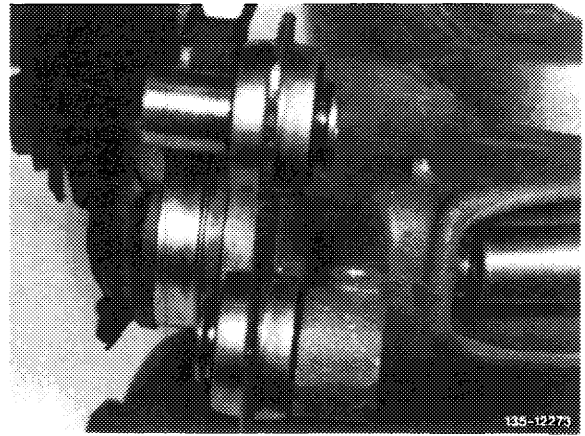

24 Unscrew brake carrier, brake carrier plate and cover plate. Turn cover plate in such a manner that the wheel carrier bearing is accessible.

25 Attach dial gauge holder with dial gauge to link bolt. Place dial gauge tip on bearing pin of wheel carrier.

26 Adjust end play of wheel carrier bearing by tightening self-locking hex nut to 0.01 (tolerance + 0.03–0.01).

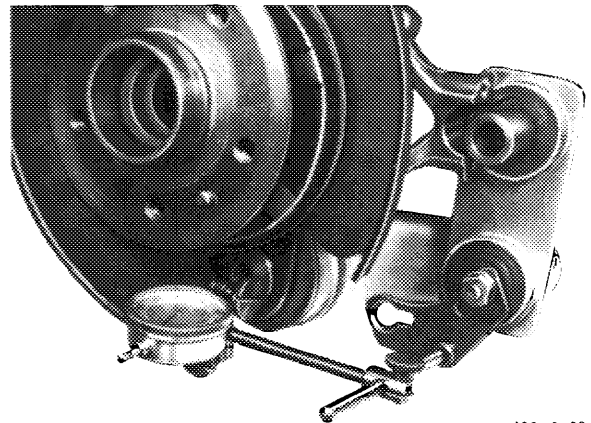

Adjustment (wheel carrier 2nd version)

27 Tighten self-locking hex nut to 40–50 Nm while simultaneously turning wheel carrier.

28 Apply one blow each against inside and outside of wheel carrier bearing pin.

Note: Apply settling blow only in combination with a brass or aluminum mandrel.

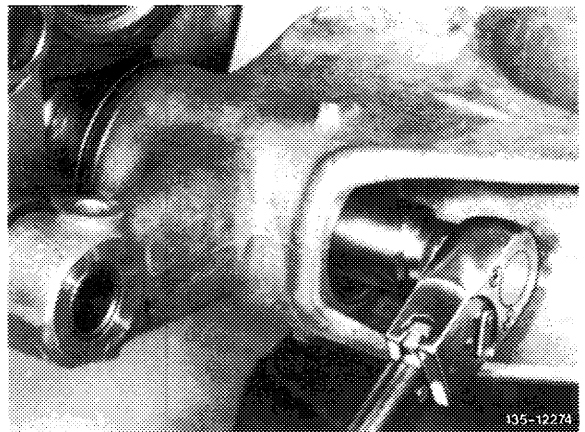

29 Check tightening torque of 40–50 Nm and tighten, if required.

30 Knock cap on wheel carrier bearing by means of punch (01).

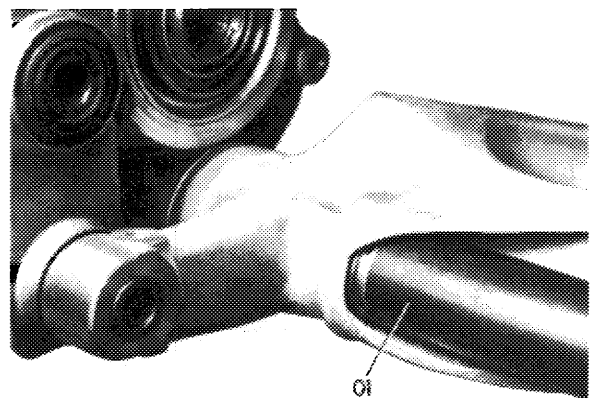

31 Attach caliper carrier to link bolt and tighten hex bolts to 25 Nm.

32 Mount cover plate, brake carrier plate and brake carrier.

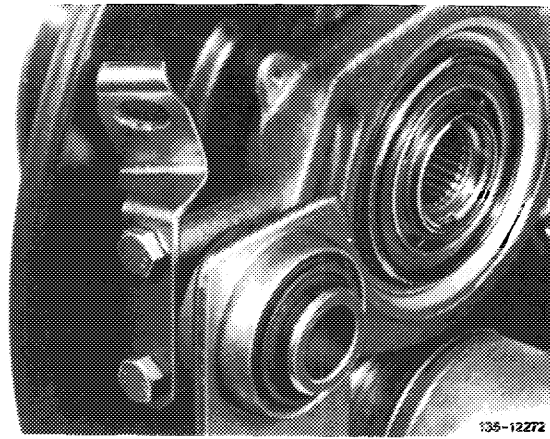

33 Install brake cable control (42–525).

34 Install parking brake, brake disc and caliper (42–530).

35 Install coupled semi-trailing arm (35–310).

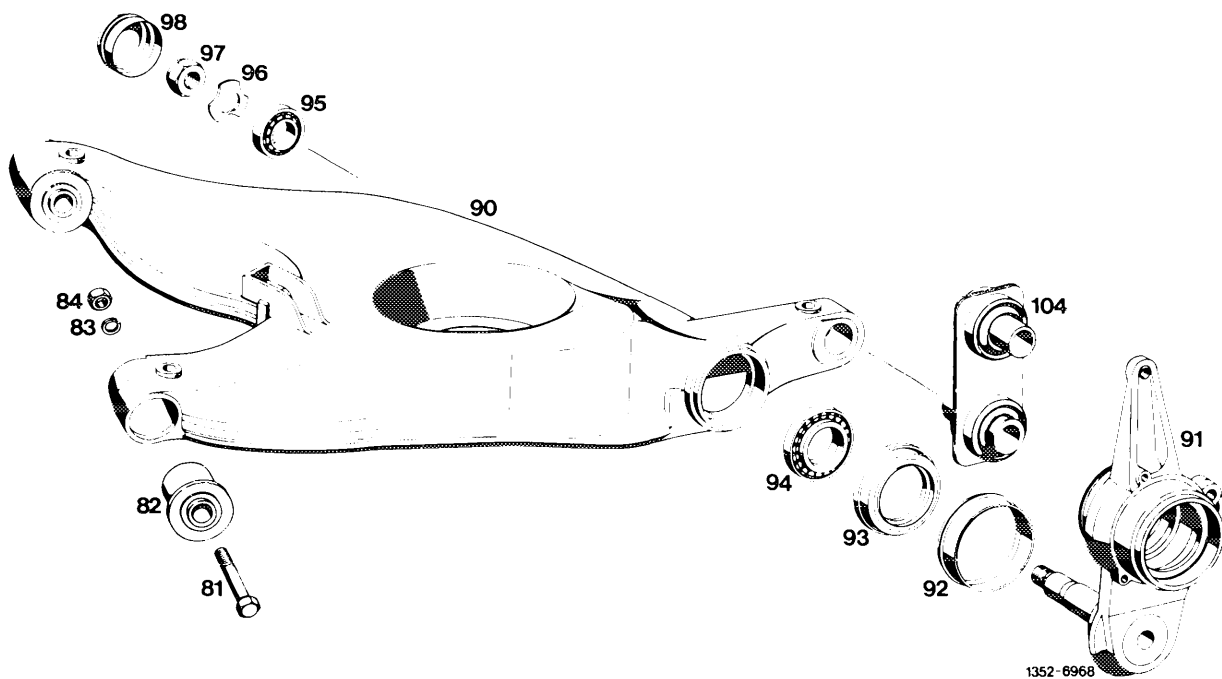

81 Hex bolt
82 Rubber bearing
83 Snap ring
84 Hex nut
90 Coupled semi-trailing arm

91 Wheel carrier
92 Protective ring
93 Radial sealing ring
94 Tapered roller bearing (outer)
95 Tapered roller bearing (inner)

96 Washer
97 Self-locking nut
98 Cover
104 Link