

41–050 Removal and installation of propeller shaft

C. Model 123

Lubricants

Centering sleeve, per sleeve approx. 6 grams

refer to specifications for service products page 266.2

Clamp connection

Tightening torques

Nm

Self-locking hex. nuts for fastening companion plates

45

Hex bolts for propeller shaft intermediate bearing

25

Hex bolts for attaching rear engine carrier to frame floor

45

Hex bolts for attaching engine mount to rear engine carrier

25

Clamping nut	2-piece shaft		30–40
	3-piece shaft	front	30–40
rear		200	

Special tools

Torque wrench 25–130 Nm
with plug-in ratchet 1/2" square

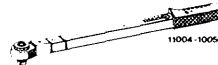

001 589 66 21 00

Torque wrench 40–200 Nm
with plug-in ratchet 1/2" square

001 589 67 21 00

Open-end wrench element 46 mm
for plugging into torque wrench



126 589 00 01 00

Removal

On vehicles with double tube exhaust system:

- 1 Remove exhaust system.
- 2 Unscrew shielding plate and remove.

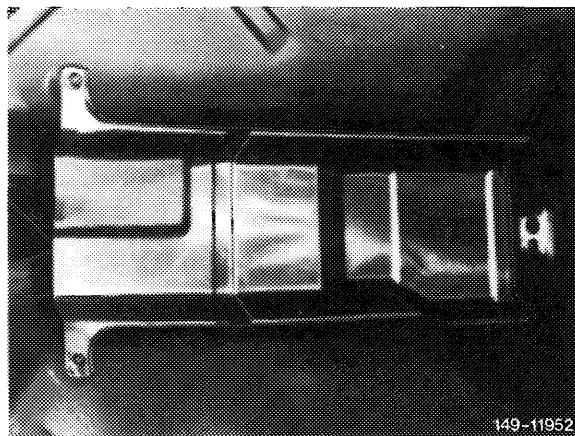

- 3 Disconnect compensating lever of parking brake.

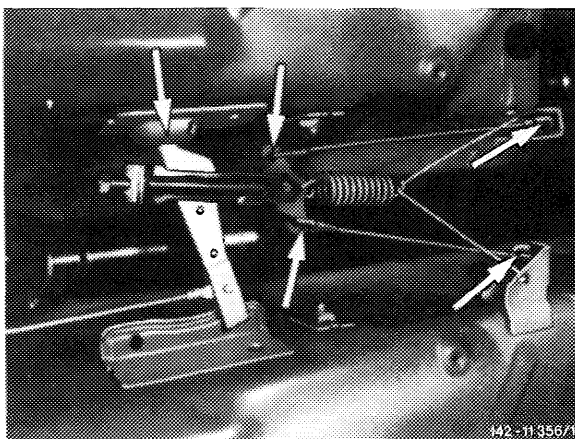

- 4 Loosen clamping nut of propeller shaft for approx. 2 turns without pushing back rubber sleeve (slides along).

On 3-piece propeller shaft, loosen front clamping nut only.

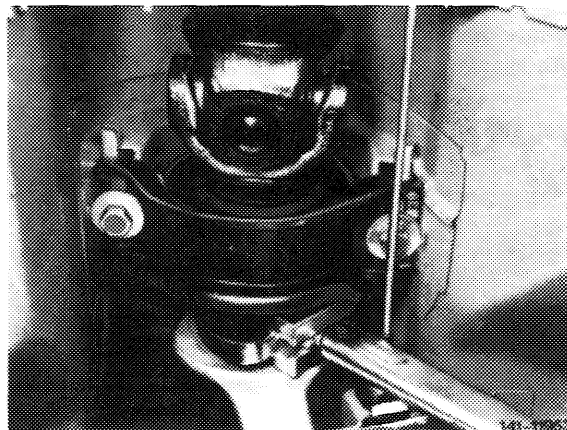

- 5 Lift transmission and jack up.

- 6 Unscrew hex screws on rear engine mount and remove.

Rear engine carrier on all 5- and 6-cylinder engines and on 4-cylinder engines with automatic transmission.

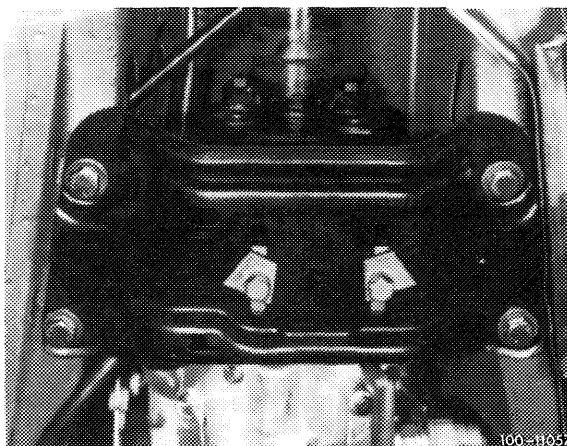

Rear engine carrier on 4-cylinder engines with manual transmission

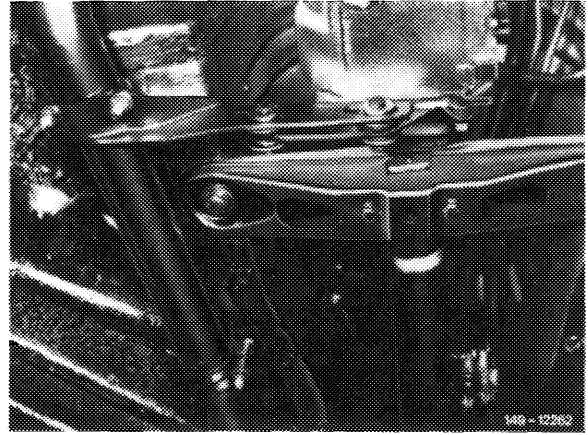

7 Unflange propeller shaft on transmission and on rear axle.

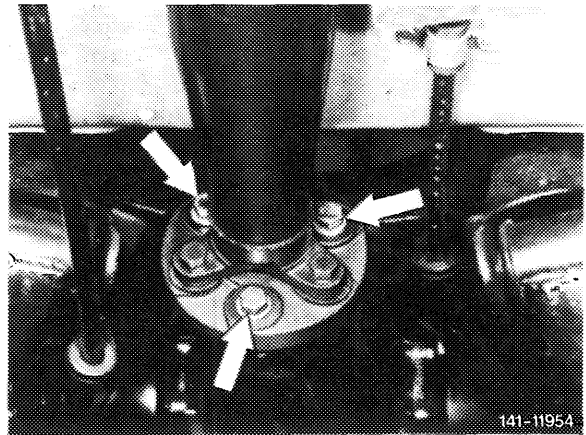

8 Unscrew hex bolts for attaching propeller shaft intermediate bearing to frame floor.

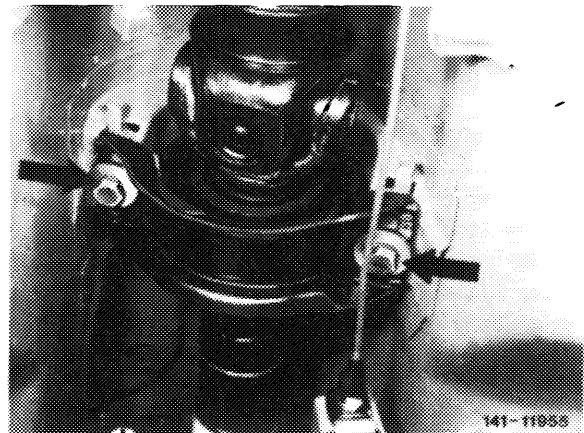

9 Force propeller shaft from centering pin of rear axle. Pull out propeller shaft without vibration eliminator toward the rear.

Make sure that propeller shaft is not separated.

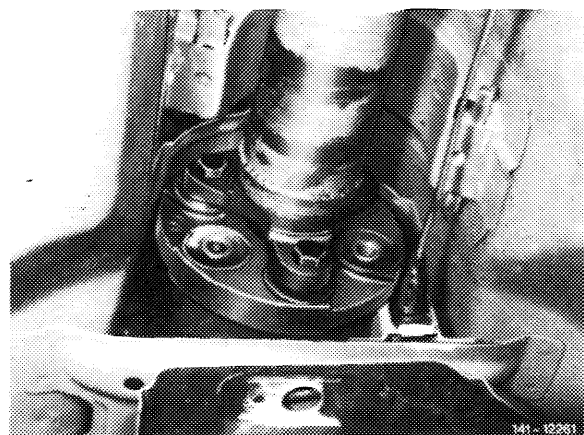

Attention!

On vehicles with radially or tangentially soft companion plates the vulcanized centering bushings of the companion plate must be loosened from universal flange prior to pushing propeller shaft back (arrows). For this purpose, use a cylindrical mandrel of 10 mm dia. and approx. 150 mm in length.

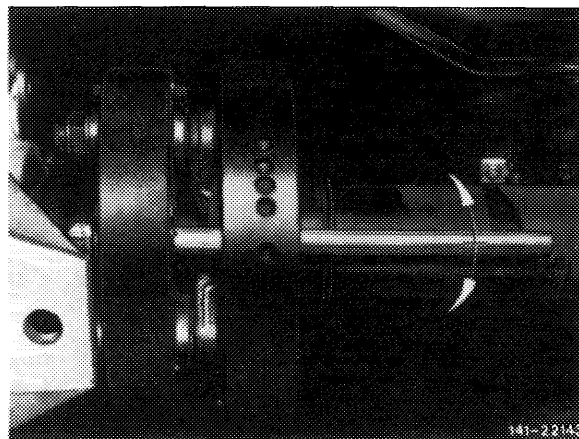

10 On vehicles up to July 1982 with 5-cylinder Diesel engine, as well as with engine 102, mark front and rear propeller shaft with vibration eliminator in relation to each other (refer to arrows). Remove front propeller shaft in forward direction and rear propeller shaft in rearward direction.

For lack of space, removal of complete propeller shaft toward the rear is not possible on vehicles with vibration eliminator.

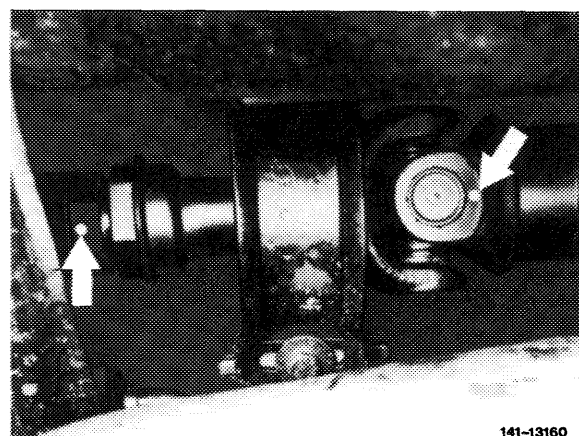

11 On all vehicles starting August 1982 the front and rear propeller shafts are pertinently identified.

The front shaft is provided with a hump and the yoke of the rear shaft with two-arrow-like humps (arrows). The hump of the front shaft should be located between the two arrows on yoke (arrows).

Note: Identification has already been available on propeller shafts prior to August 1982, but not been taken into consideration during assembly. For this reason, propeller shafts on which the marks are not in agreement must be identified prior to removal and the two parts must be plugged together again in accordance with this identification.

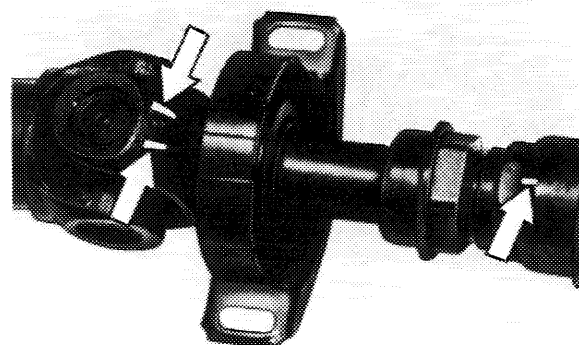

12 Starting September 1979, vehicles with engine 115 are provided with a 2-part propeller shaft with vibration eliminator, instead of a 3-part shaft. Here, a separation of front and rear propeller shaft is not required, since the diameter of the vibration eliminator is smaller. As a result, the complete propeller shaft can be removed toward the rear.

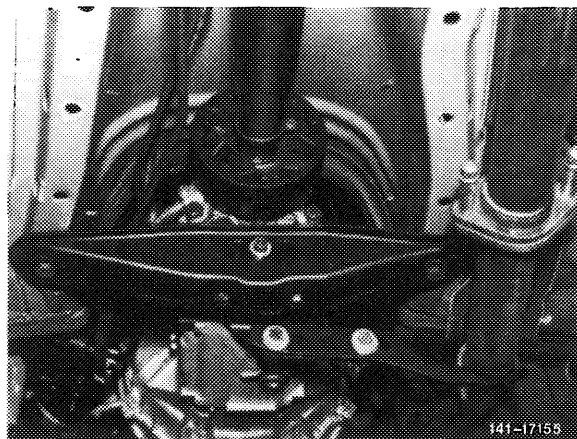

13 Check companion plates (12), centering sleeves (10) and propeller shaft intermediate bearing for damage, replace damaged components.

Attention!

If the propeller shaft must be separated, mark components in relation to each other since the propeller shaft is fully balanced.

The vibration eliminator (20) itself cannot be replaced. If vibration eliminator is defective, replace front propeller shaft or complete propeller shaft.

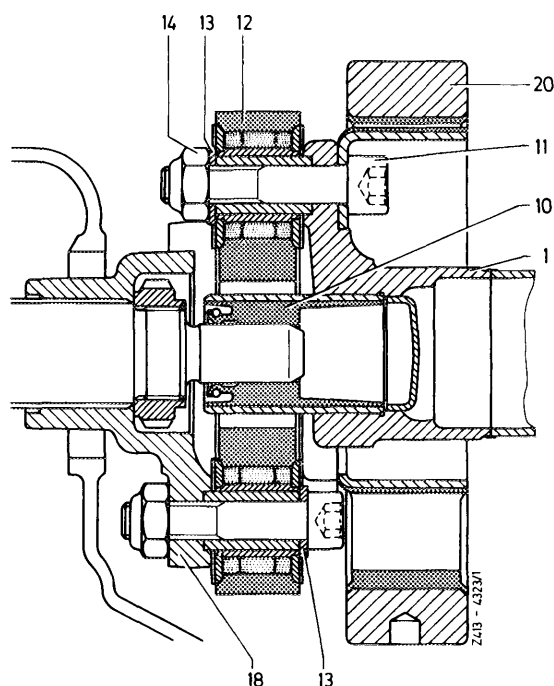

- 1 Front propeller shaft
- 10 Centering sleeve
- 11 Hex socket screw
- 12 Companion plate
- 13 Washer
- 14 Self-locking hex. nut
- 18 Universal flange
- 20 Vibration eliminator

On vehicles with vibration damper up to August 1981

14 If during renewal of companion plate the vibration eliminator is separated from propeller shaft, mark vibration eliminator and three-arm flange in relation to each other (arrow).

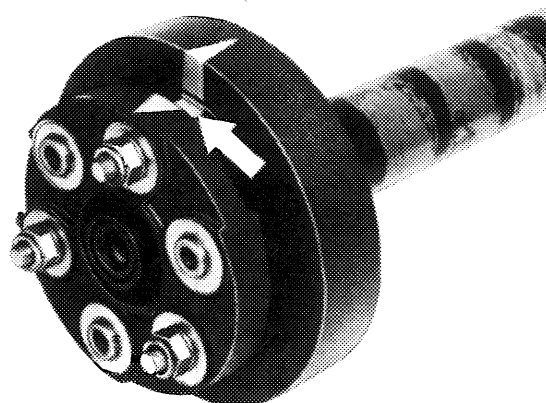

141 - 10859

On vehicles with vibration eliminator starting September 1981

15 If during renewal of companion plate the vibration eliminator is separated from propeller shaft, assemble vibration eliminator and three-arm flange as marked. The installation position is in order, if the arrow of vibration eliminator points toward hump on three-arm flange.

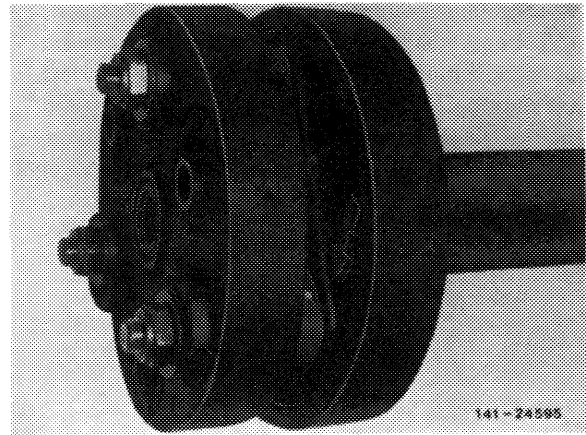

Installation

16 Fill cavities of the two centering sleeves with specified grease (approx. 6 grams per sleeve).

17 Slip propeller shaft without vibration damper on centering pin on transmission and on rear axle.

Note: Also refers to vehicles with engine 115, starting September 1979, with vibration eliminator.

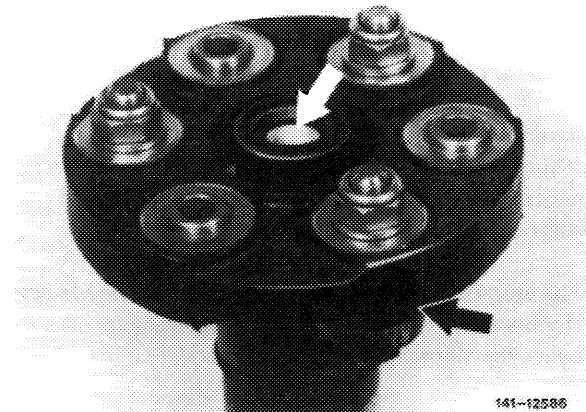

18 Push front propeller shaft with vibration eliminator from the front through the bridge and slip on centering pin on transmission. Push rear and front propeller shaft, **as marked**, together at clamp connection and attach to centering pin on rear axle.

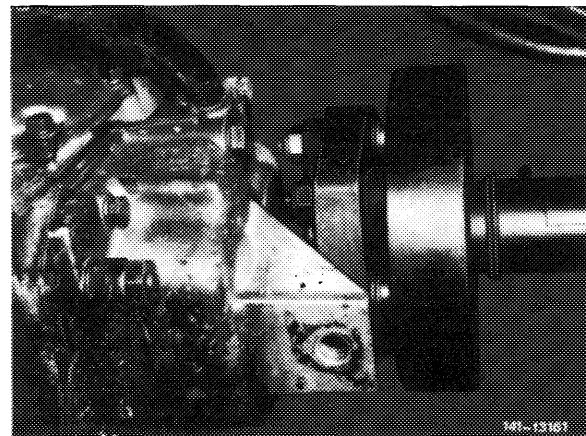

19 Attach propeller shaft intermediate bearing to frame floor, but do not yet tighten.

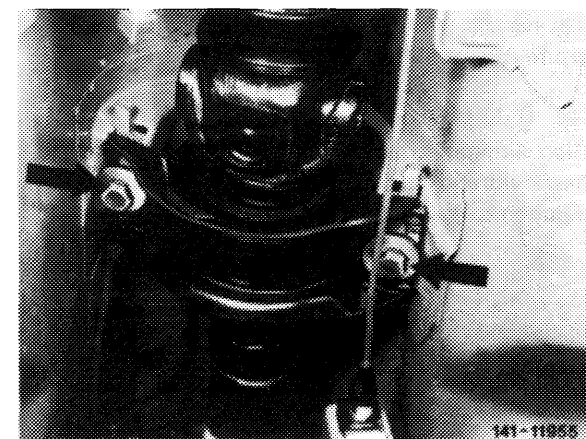

20 Flange propeller shaft to transmission and to rear axle. Tightening torque of self-locking hex nut 45 Nm.

Attention!

Renew self-locking hex. nuts on principle.

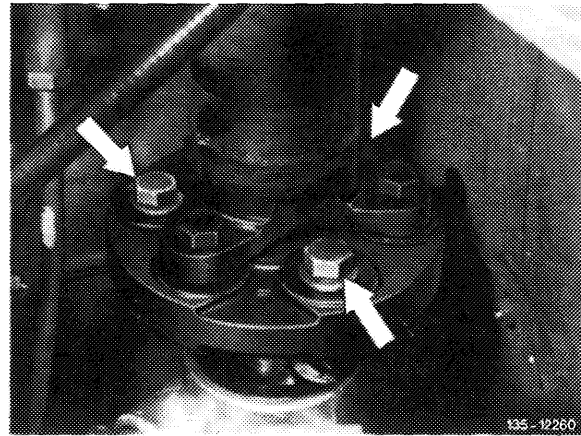

21 Mount rear engine carrier. Tightening torque of hex screws 45 Nm.

22 Lower transmission and position hex bolts for rear engine mount and tighten to 25 Nm.

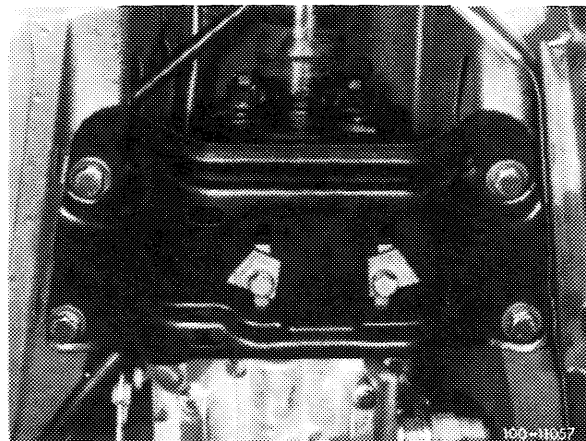

23 Attach cable controls and compensating lever of parking brake and adjust (42–525).

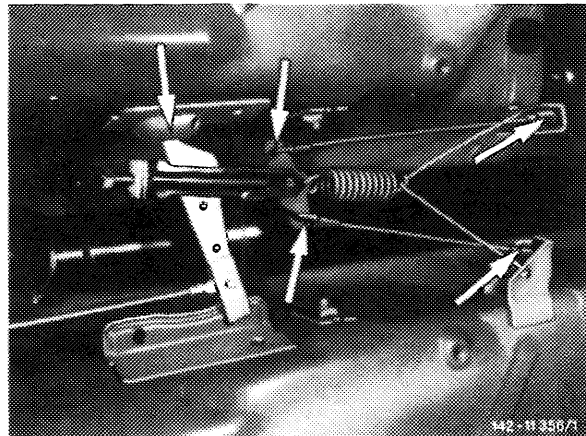

24 Tighten clamping nut on propeller shaft. Watch out for good seat of sleeve. Tightening torque of clamping nut on 2-piece propeller shaft 30–40 Nm and on 3-piece propeller shaft front 30–40 Nm, at rear 200 Nm.

Note: Prior to tightening clamping nuts on intermediate shaft of 3-piece propeller shaft, make sure that the intermediate shaft is not knocking against front or rear propeller shaft intermediate bearing. This means that at its end the intermediate shaft should have approx. the same distance in relation to pertinent intermediate bearing.

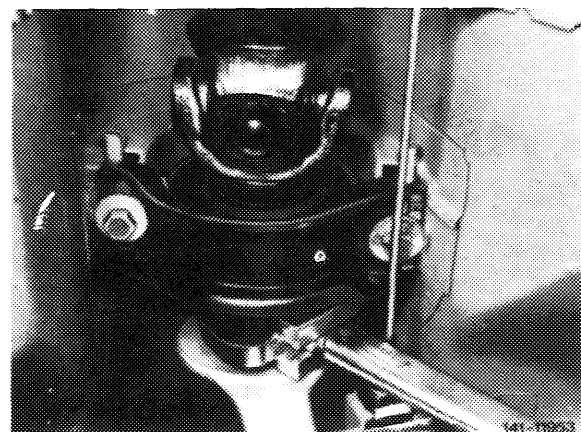

25 Tighten hex. bolts for attaching propeller shaft intermediate bearing to frame floor to 25 Nm.

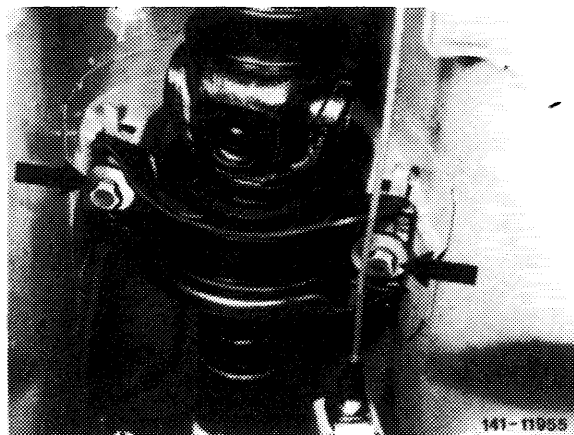

On vehicles with double tube exhaust system:

26 Mount shielding plate.

27 Install exhaust system.

