

## 42–150 Replacement of piston seal on front axle caliper

### Data

Caliper – make	Teves SS 2–60 Bendix FE 60
Housing dia.	59.99 60.04
Shaft width for brake pads	90 + 0.15

### Lubricant

ATE brake cylinder paste

### Special tools

Impact puller

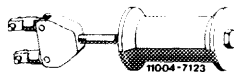

123 589 06 33 00

Puller for stuck brake pads

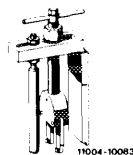

123 589 07 33 00

Piston resetting pliers



123 589 00 37 00

Piston rotating pliers

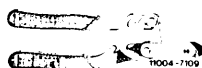

000 589 50 37 00

Pliers for attaching dust cap



000 589 49 37 00

Installation tool for heat shield

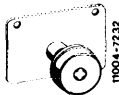

000 589 51 43 00

Gauge for piston position

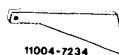

000 589 34 23 00

### Conventional tool

Open double box wrench 9 x 11 mm

e.g. made by Hazet, D-5630 Remscheid  
order No. 612

## Note

Do not separate the two halves of the caliper since the fastening bolts are tightened to a definite torque by the manufacturer.

When replacing piston seal in Bendix caliper, make sure that the pressed-on ring is not forced off when dust cap is removed (refer to arrow). The ring is not available as a spare part.

If the ring is corroded, experience has shown that the cylinder bore is also damaged. In such a case, exchange complete caliper.

## Removal

- 1 Remove brake pads (42–160).
- 2 Force dust cap (9) from housing by means of a screw driver.

Teves version

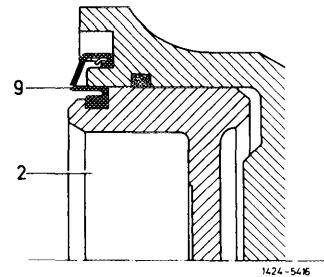

Bendix version

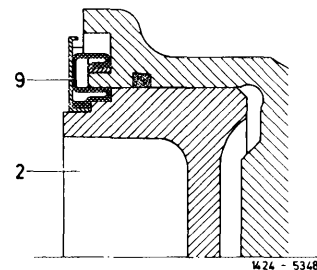

- 3 Hold one piston (2) in caliper with piston resetting pliers (018). Then press-out opposite piston by means of compressed air of approx. 0.5 bar.

**Note:** If the pistons are rusted down, install a new caliper.

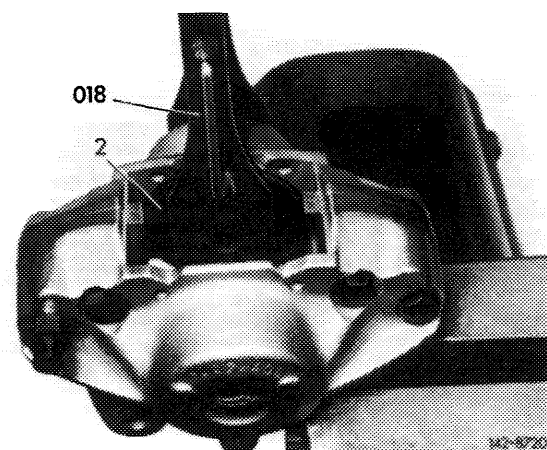

4 Remove piston seal (3) from groove of cylinder bore.

- 1a Outer caliper half
- 1b Inner caliper half
- 2 Piston
- 3 Piston seal
- 4 Brake pad
- 5 Holding pin
- 6 Brake disc
- 7 Heat shield
- 8 Clamping ring
- 9 Dust cap

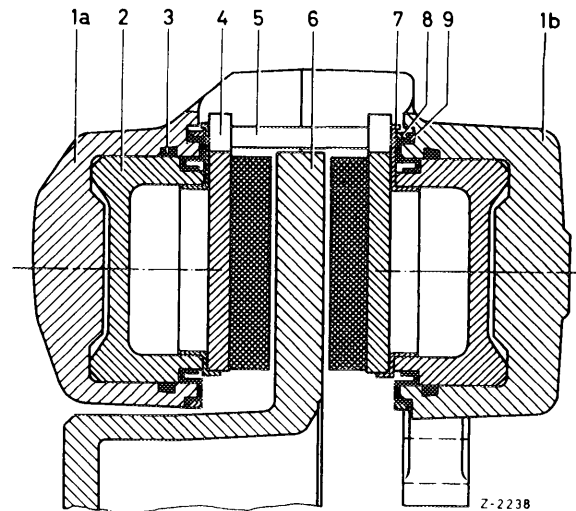

### Inspection and repair

5 Push heat shield (7) away from piston.

6 Remove deposits on piston with a soft brass-wire brush or a rough cleaning cloth. Do **not** work on pistons with polishing or emery cloth, since this might damage the chrome-plated surface. Replace piston if chrome surface is damaged.

7 Check cylinder bores of caliper for wear. Replace complete caliper if bores are scored or rusted. Remove small, minor rust spots in bore with polishing cloth, heavier rust spots in front of piston seal groove with fine emery paper (380 to 500 grain).

### Installation

8 Coat new piston seal (3) slightly with ATE brake cylinder paste and insert into groove of cylinder bore.

**Note:** When reconditioning Bendix caliper, make sure of a tight and correct seat of pressed-on ring (refer to arrow).

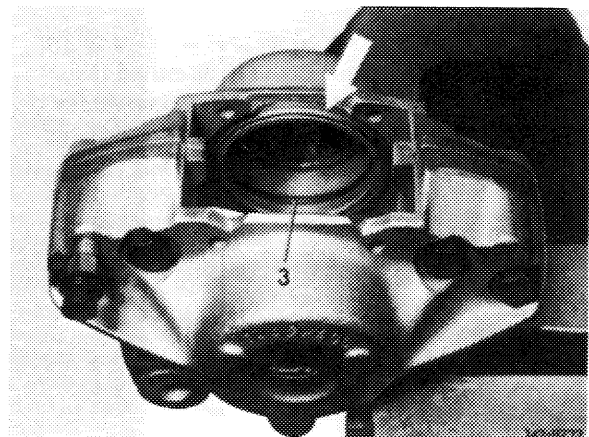

9 Insert piston (2) into bore of caliper. Then check position of piston in caliper with piston gauge (019).

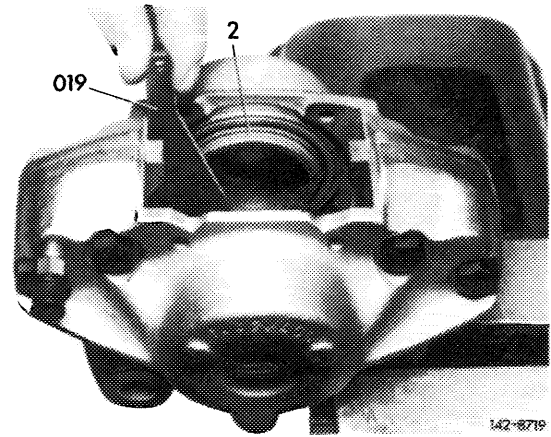

**Note:** When installing pistons, note different piston versions.

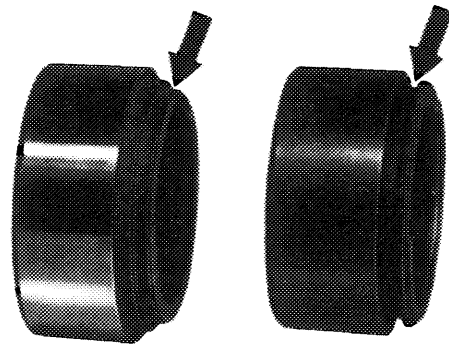

Left: Bendix piston  
Right: Teves piston

142-8643

10 Move piston (2) into correct position with piston pliers (020), if required.

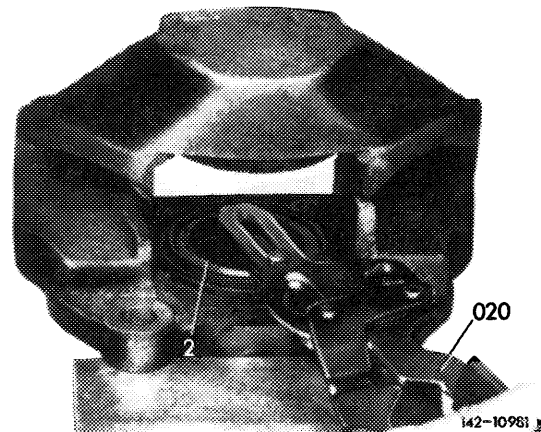

**Attention!**

Insert piston in such a manner that with the caliper installed the elevation (marked in black) on the piston is facing upwards. This elevation serves for one-sided contact of the brake pads while braking, which will reduce the tendency to squeal.

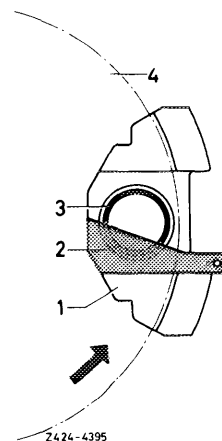

11 On Teves caliper, mount dust cap (9) on piston (2) and position against collar of caliper.

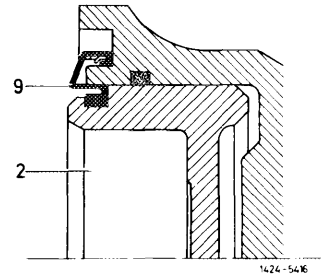

12 Place dust cap (9) on collar of caliper by means of pliers (026) and pertinent discs (027).

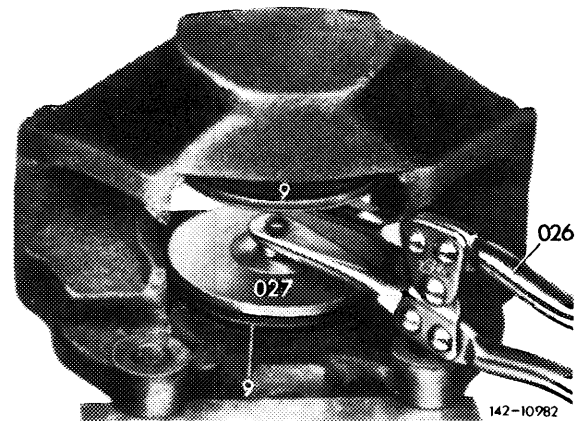

13 Insert heat shield (7) into piston with the recess in the shield fitting accurately into the elevation of the piston.

14 Place insertion device (17) into caliper and press heat shield into piston.

**Attention!**

The elevation on the piston should project at least 0.1 mm beyond heat shield. The heat shields for the inner and the outer piston are different.

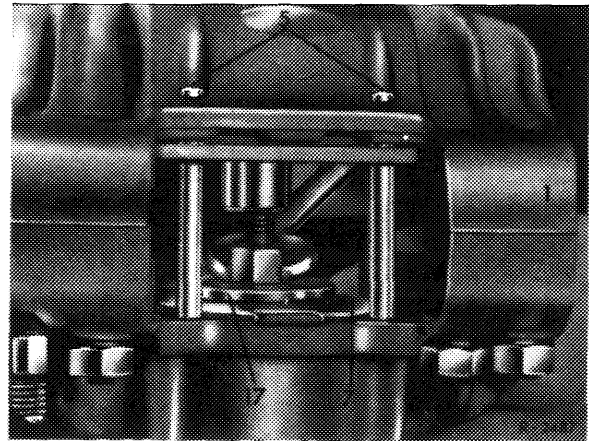

15 On Bendix caliper, press heat shield (7) on piston according to piston position.

**Attention!**

The elevation on the piston should project at least 0.1 mm beyond heat shield.

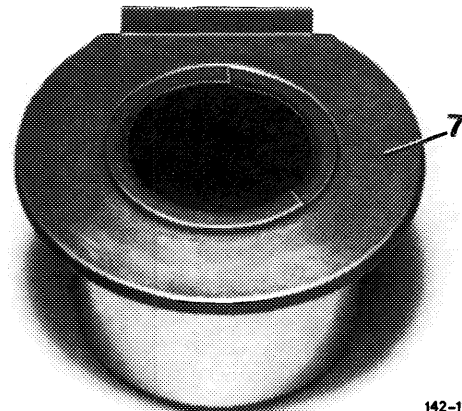

16 Place dust cap (9) on piston (2).

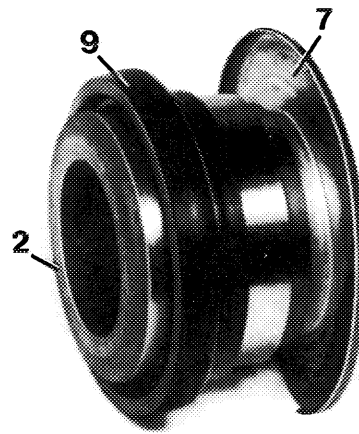

142-11654

17 Use blunt installation needle to mount dust cap (9) on collar of caliper. Then push piston completely back until dust cap (9) is perfectly seated on piston collar.

18 Install brake pads into caliper (42-160).

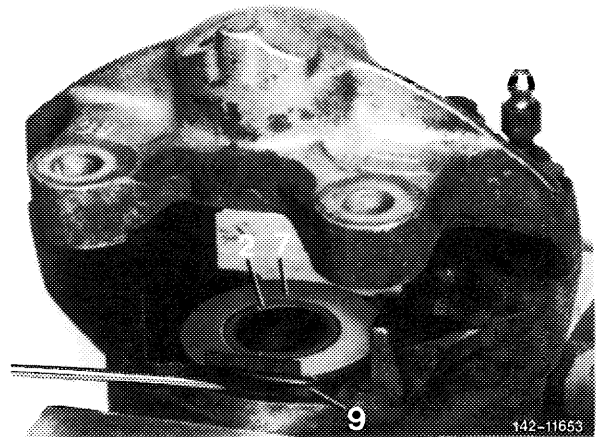

142-11653