

General

The utilization of pneumatic pressure-difference forces for completing certain functions in a vehicle is increasingly gaining in significance. Well known examples for the employment of such pneumatic forces are the adjustment of the firing point by means of a vacuum

Principle

Pneumatic power is obtained when one chamber of a cylinder subdivided by a diaphragm or a piston is bled or evacuated, while the other chamber is filled with air. The evacuated chamber is subject to a vacuum, the air-filled chamber is under atmospheric pressure. The resulting difference in pressure between the two chambers will lead to a pertinent movement of the diaphragm or piston in the direction of the vacuum. When this movement of the diaphragm or piston is transmitted to a linkage, the available power can be effectively employed by means of the respective linkage. Pertinent reversal of the pressure and vacuum end permits double functions.

as well as brake force boosters operating on the same principle. Likewise, pneumatic power is now also employed for a number of controlling and operating functions to provide additional safety and comfort.

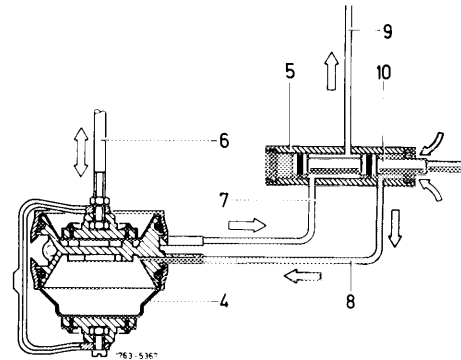

- | | |
|---------------------|------------------|
| 4 Operating element | 8 Charging line |
| 5 Vacuum switch | 9 Vacuum line |
| 6 Actuating rod | 10 Control valve |
| 7 Evacuating line | |

Vacuum sources in vehicle

A vacuum source for pneumatic systems in motor vehicles is provided by the intake pipe of the engine. The intake pipe of a 4-stroke Otto engine is providing particularly favorable pressure conditions for operating vacuum systems. On Diesel engines, on the other hand, the available vacuum is insufficient for such purposes and requires the assistance of a pump.

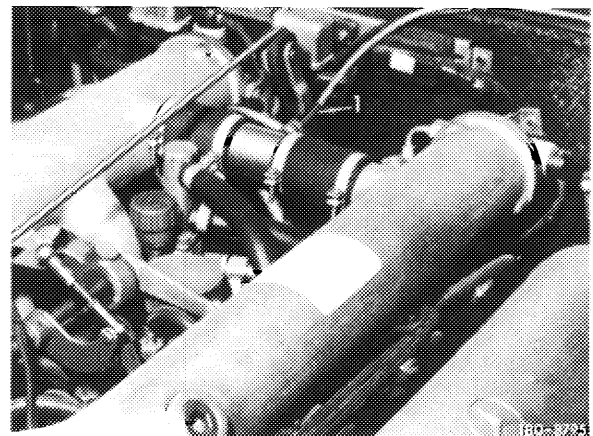

Vacuum connection on engine 100.980

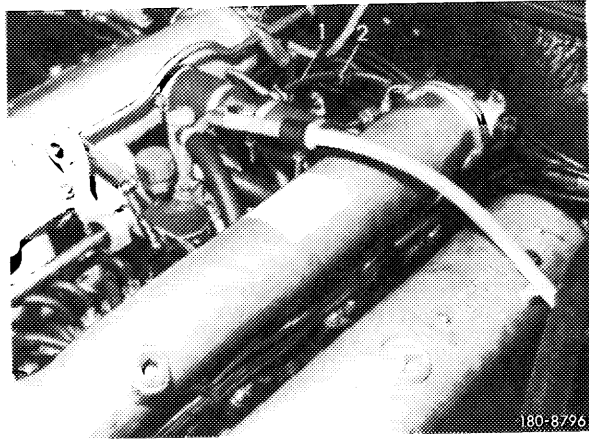

Vacuum connection on engine 100.981

180-8796

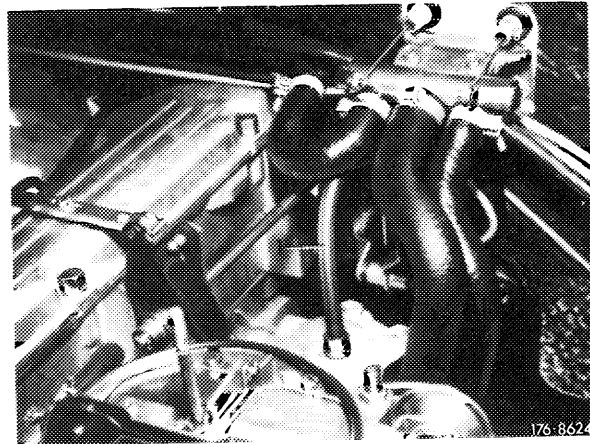

Vacuum connection on engine 110.92

176-8624

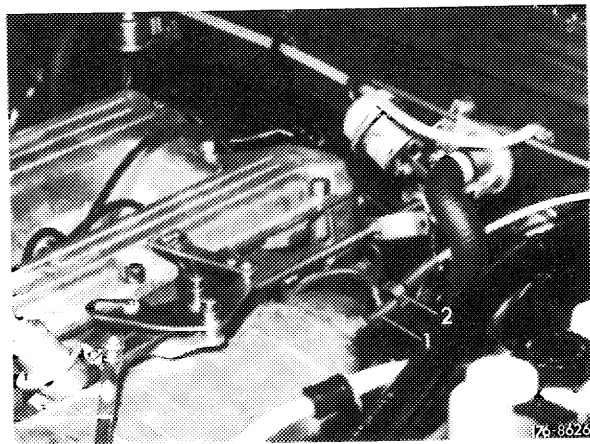

Vacuum connection on engine 110.98

176-8626

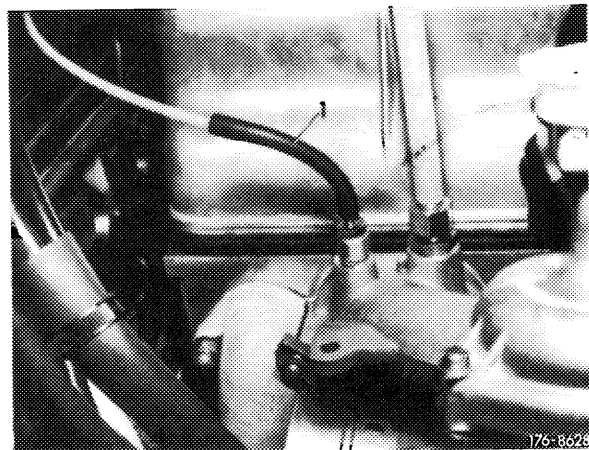

Vacuum connection on engine 115

176-8623

Vacuum connection on engine 116, 117

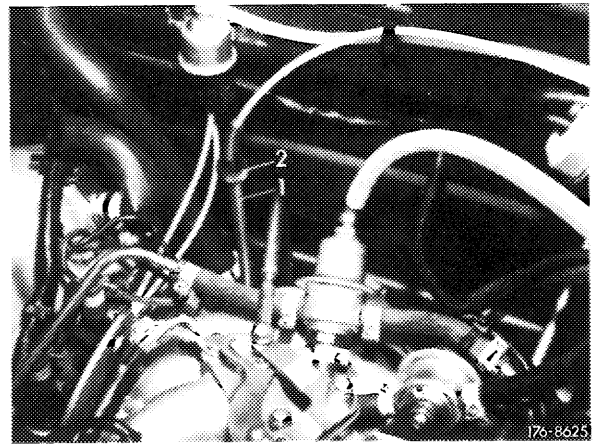

Vacuum connection on engine 130.920

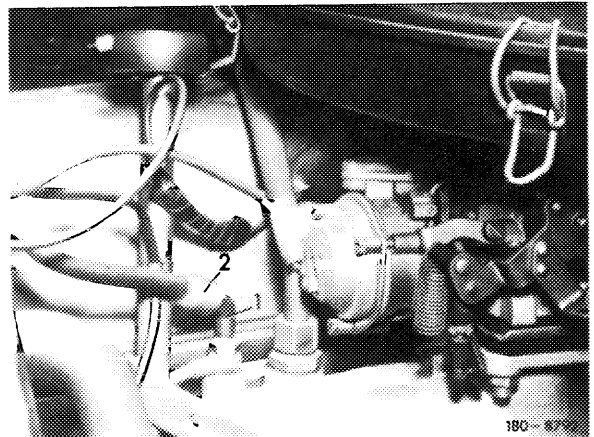

Vacuum connection on engine 130.923

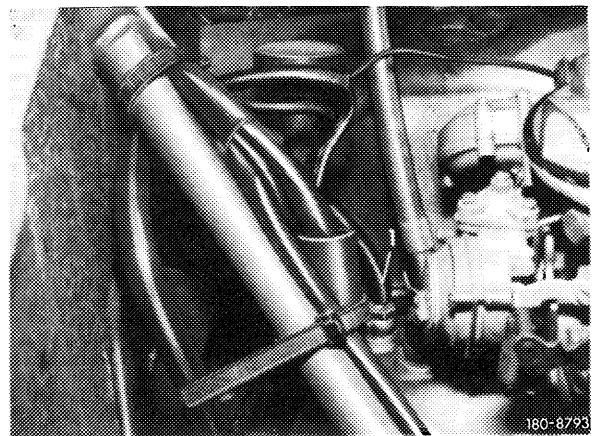

Vacuum connection on engine 130.980

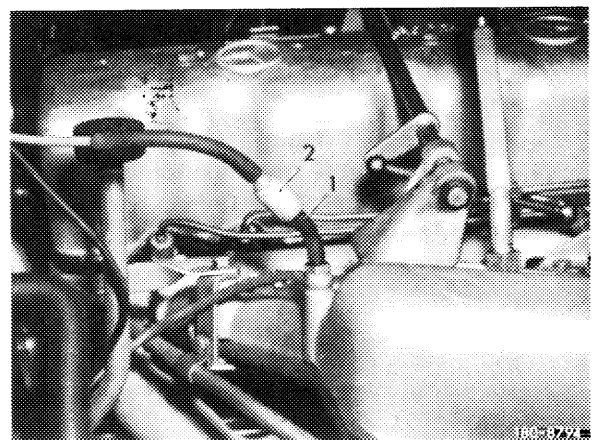

Vacuum connection on engine 180

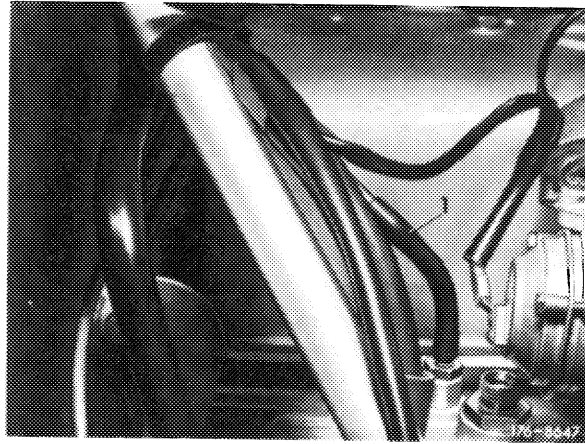

Vacuum connection on engine 615, 616, 617

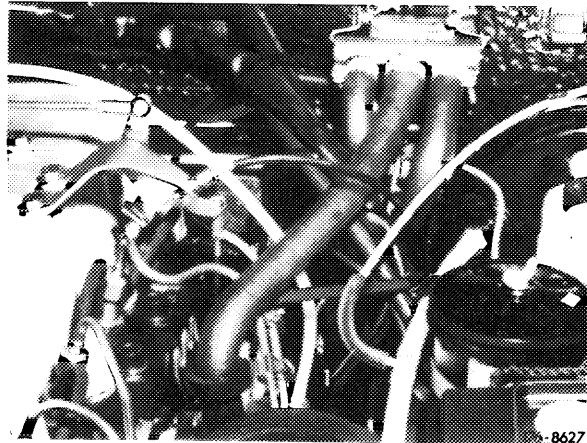

Vacuum lines, connecting elements, check valves and supply tanks

The transportation of the vacuum to the consumers, that is, to the operating elements, the switches and the control valves inside the vehicle is effected by means of dimensionally stable polyamide B lines. These lines are flexible only to a certain extent and must be cut around close bends and coupled by means of connecting rubber elements. These connecting elements are available in versatile shapes such as elbows, T-pieces, Y-pieces etc. A check valve is installed in intake line to protect the system. In the event of a vacuum loss in the engine, the vacuum in the system will remain intact, that is, when the pressure drops, the check valve will close and thereby separate the two systems in relation to each other. In addition, another check valve is installed in the line toward the vacuum-supply tank. This valve protects the stored vacuum in the supply tank, that is, when the engine is stopped and no more vacuum is established, the vacuum in the supply tank remains intact. As a result, the operating elements can be operated a few more times after the engine has been stopped, until the supply tank is empty.

Operating elements

As explained in the paragraph covering the principle of the system the differential pressure between the pressure and the vacuum end is made available by means of a diaphragm.

The operating elements installed in the vehicles are pertinently designed. Additional refinements are double diaphragm elements instead of elements using just one diaphragm. The function of the respective operating element is shown in the various sectional illustrations.

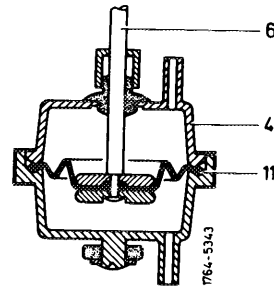

4 Vacuum element with one diaphragm
6 Control rod
11 Diaphragm

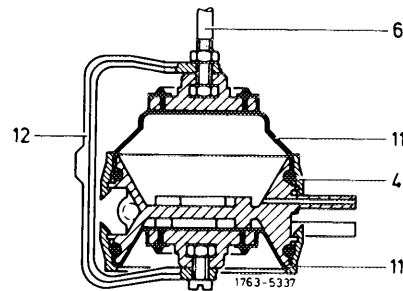

4 Vacuum element with two diaphragms
6 Control rod
11 Diaphragm
12 Connection

Control by means of vacuum switch or spring force

Switches in the shape of control valves are provided for controlling the operating elements or direction of operation. Actuation of these switches will reverse the prevailing direction of pressure and vacuum. As a result, the operating direction of the operating element will reverse.

Single acting working elements, that is, elements influenced at one end by the vacuum, are controlled by means of a charging valve and draw spring combination. The controlling process proceeds in such a manner that the system is charged with air by means of the respective charging valve. As soon as the vacuum in the system has been sufficiently eliminated, the spring attached to the linkage will become effective for counteraction. When the charging valve is closed, the spring force is superimposed by the pneumatic force and cancelled.