

A. Sedan

**Removal**

---

- 1 On vehicles with seat height adjustment, move seat into top position.
- 2 Push front seat forward.
- 3 Disconnect draw spring by means of a hook.

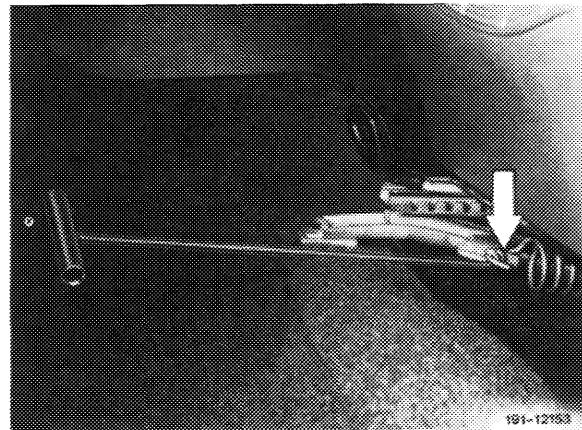

- 4 Remove screw on slide rail and pull slide rail out of seat fitting.

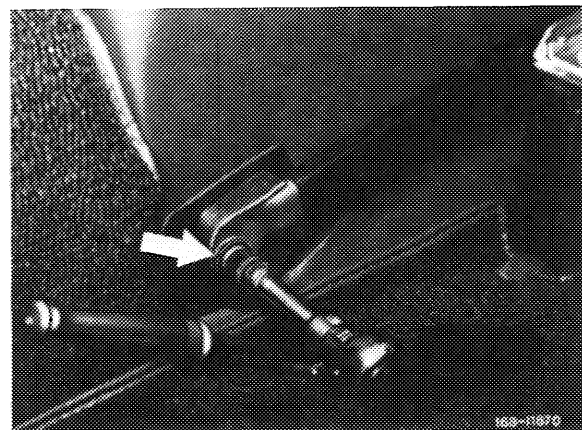

- 5 Unscrew rear screws on both seat guide rails.
- 6 On vehicles without seat height adjustment, additionally remove screw (arrow) on side member.
- 7 Move height adjustment into bottom position and push seat toward the rear.

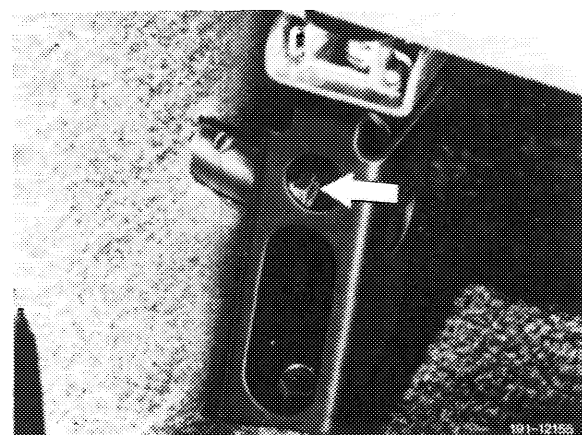

8 Unscrew front screws on both seat guide rails.

9 Remove front seat.

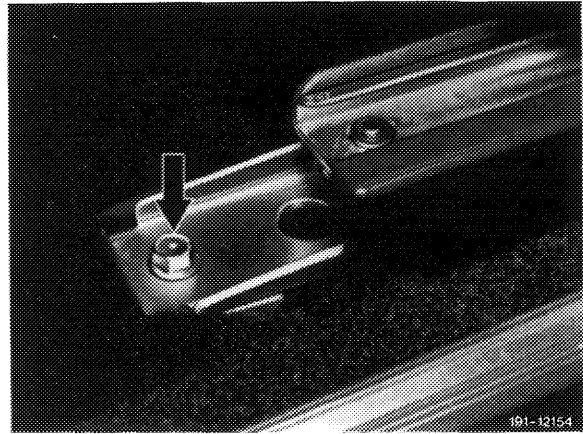

## Installation

10 Push both guide rails forward and attach draw spring with a rubber ring.

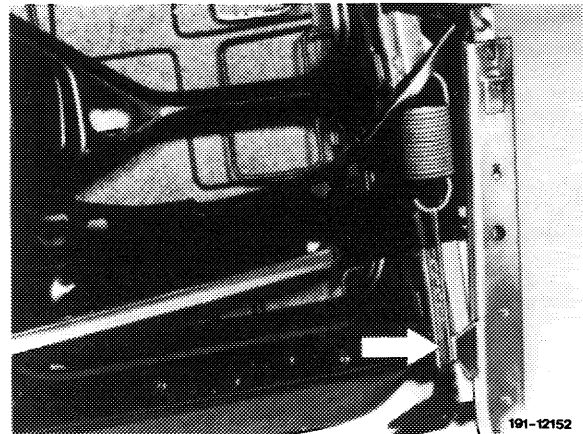

11 Align bracket for attaching seat to rear consoles (arrow) and to cross member.

12 For further installation proceed vice versa.

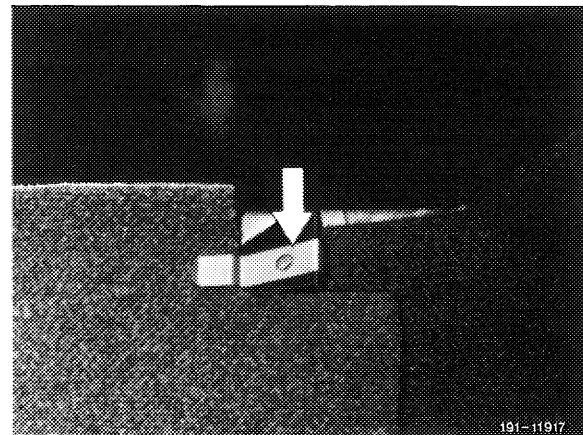

**Note:** The slide rail is inserted through opening on reclining seat fitting and is attached at the rear only.

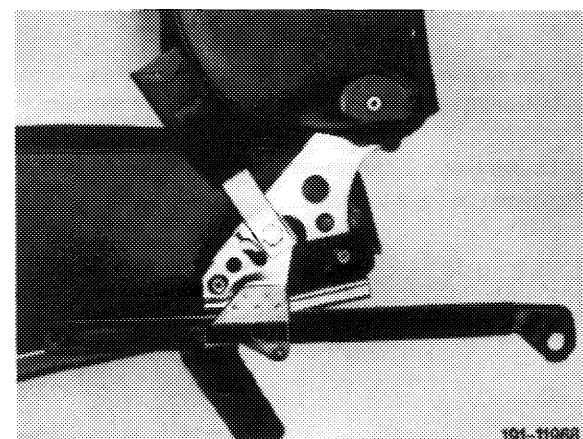

## B. Coupe

### Remove

---

1 Push driver's seat in the upper position.

2 Unhook tension spring with a hook.

3 Push driver's seat forward.

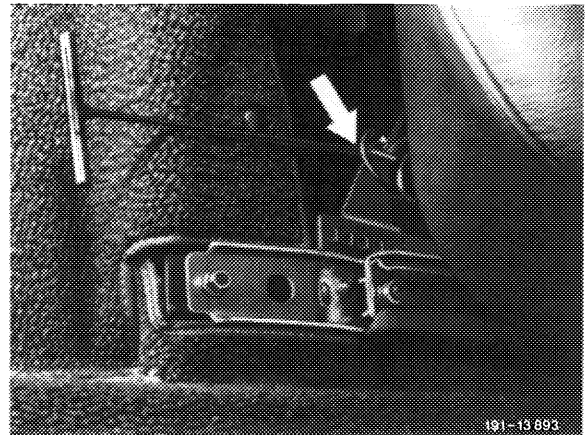

4 Unscrew screw at the slide rail and pull slide rail out of seat fitting.

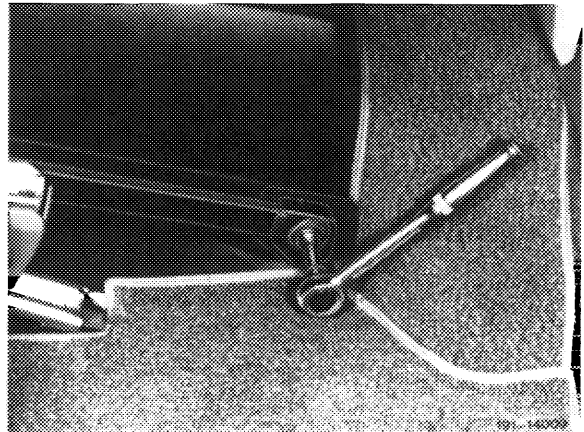

5 Remove both screws at the rear of the seat guide rails.

6 Push height adjustment down and driver's seat backwards.

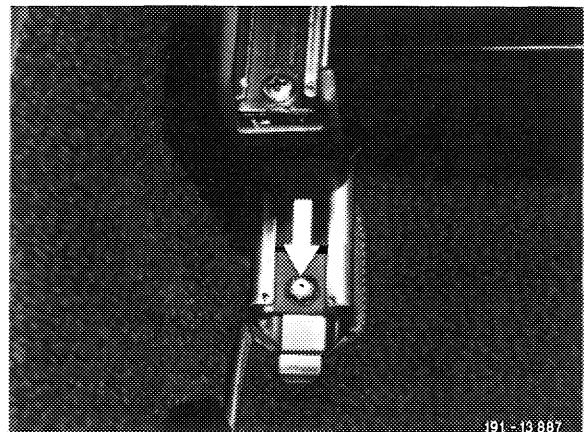

7 Remove screws from both front seat guide rails.

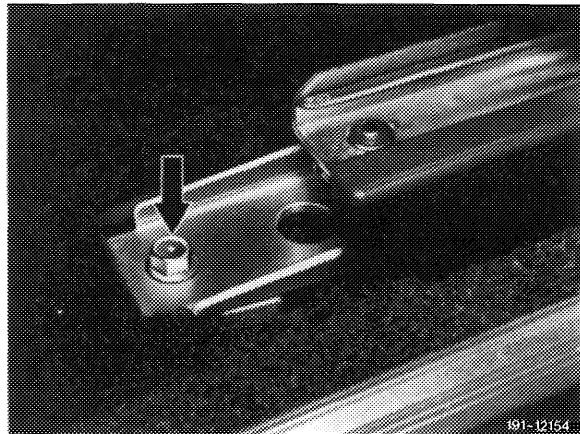

8 Pull off vacuum line at connection piece.

9 Lift out driver's seat.

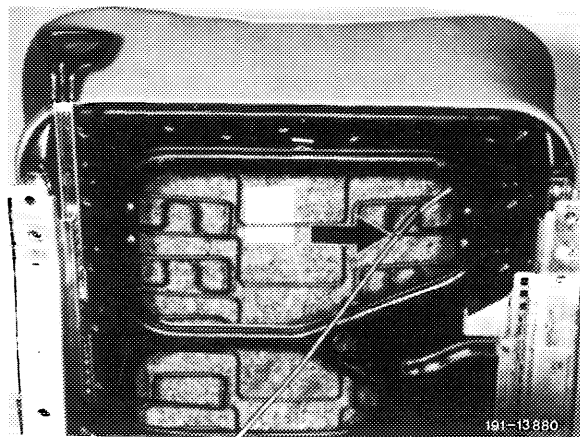

## Install

10 Push both guide rails forward and hook tension spring into the rear of the driver's cushion frame. To facilitate assembly, connect the front of the tension spring and the front hooking point at the driver's cushion frame with a rubber ring (arrow).

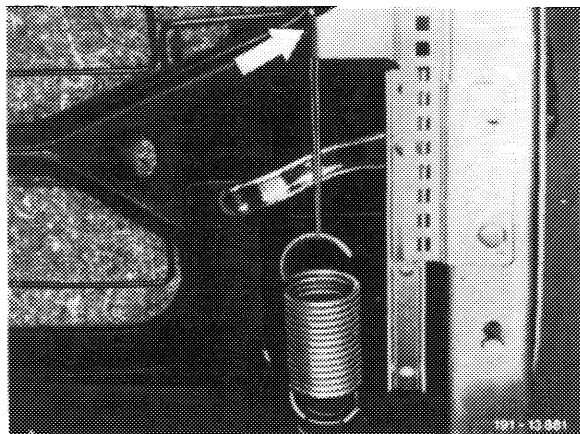

11 Align seat mounting bracket at the rear consoles and at the cross member.

12 Further installation takes place in reverse order.

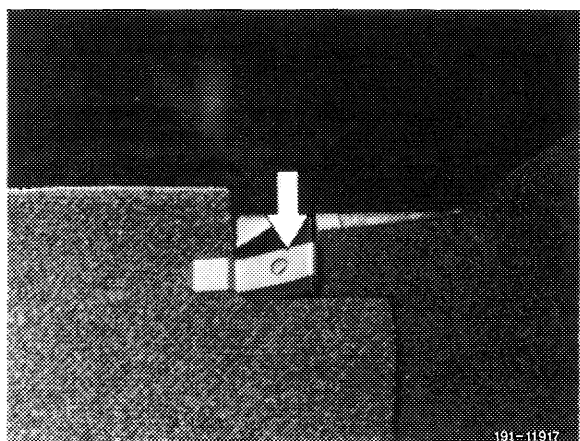

**Note:** The slide rail is inserted into the opening at the rest seat fitting and only mounted at the rear.

