

83–100 Removal and installation of heater box

Note

Starting August 1980 a modified heating/venting system is installed. It is externally recognized by the **two** control levers for controlling the air in upward or downward direction. Pay attention to revised scope during removal and installation.

1st version

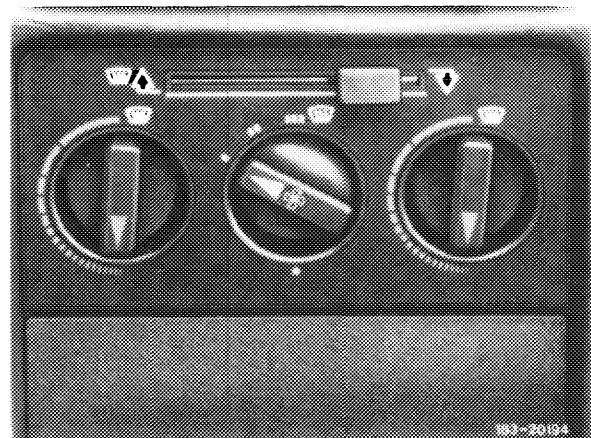

2nd version

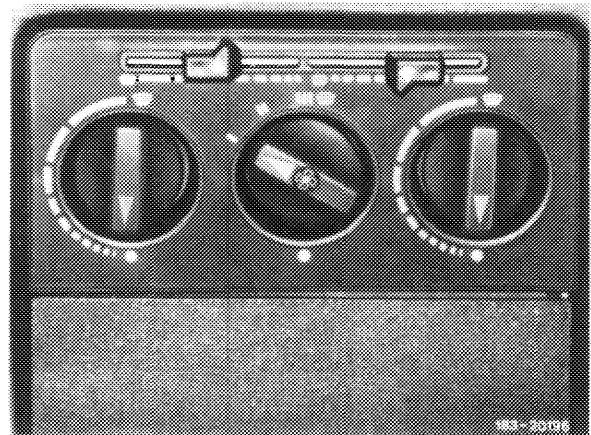

Removal

- 1 Remove floor mats in driver's leg area.
- 2 Remove center console and both covers under instrument panel (68–200 and 68–150).
- 3 Push driver's seats completely back.
- 4 Drain approx. 2 litres of cooling water.

- 5 Disconnect heater hoses.
- 6 Remove glove box (68–140).

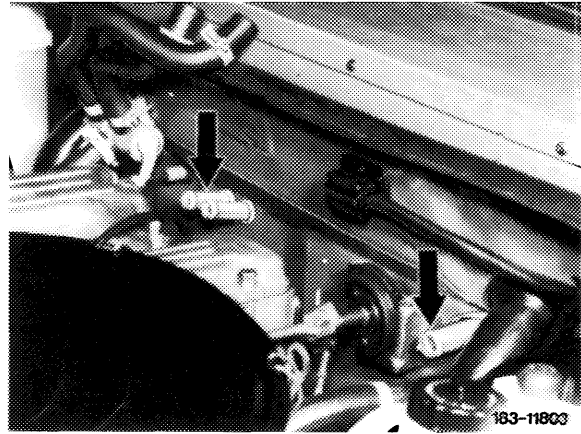

- 7 Pull both plugs from switch for glove box lights.

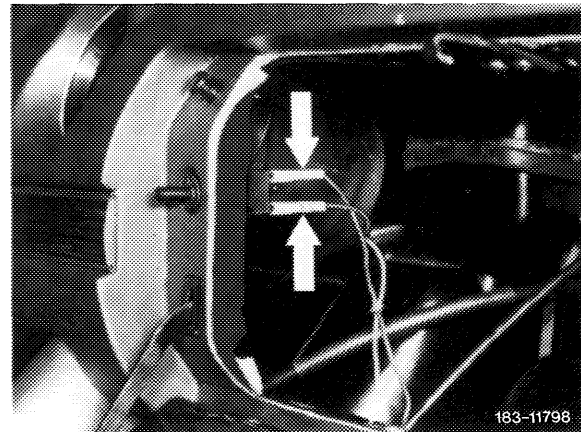

- 8 Unscrew screws on air ducts left and right for rear compartment's heater.

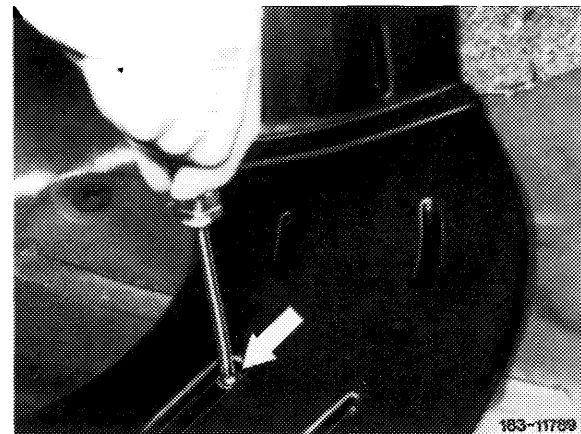

- 9 Remove air ducts on transmission tunnel. On heater box 2nd version, unscrew holding straps and disconnect.

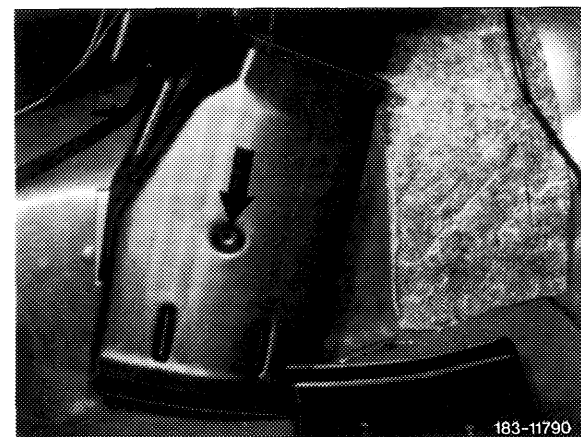

10 Pull off connecting hoses toward lateral ring nozzles left and right on heater box.

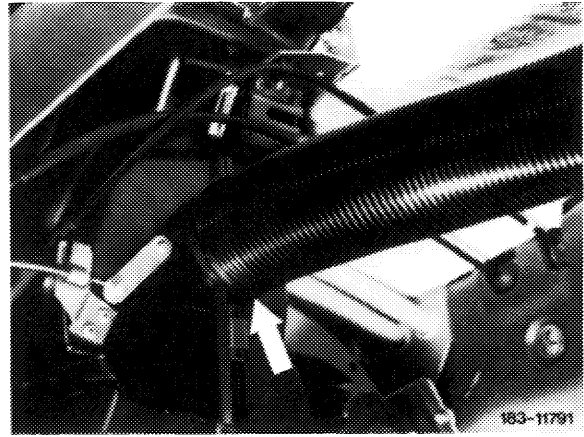

11 Pull off connecting hose between heater box and the two center fresh air nozzles.

12 Disconnect connecting lever toward fresh air flap (arrow).

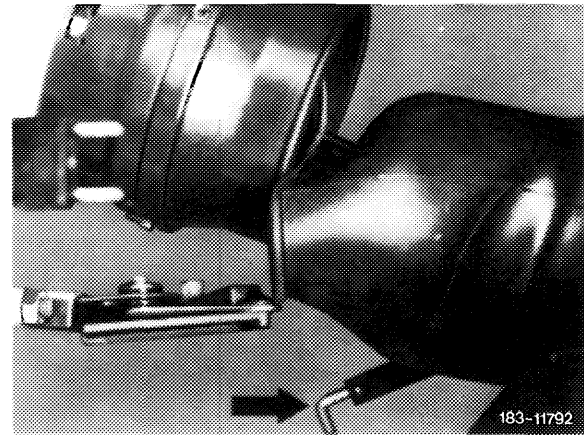

13 Remove support on transmission tunnel.

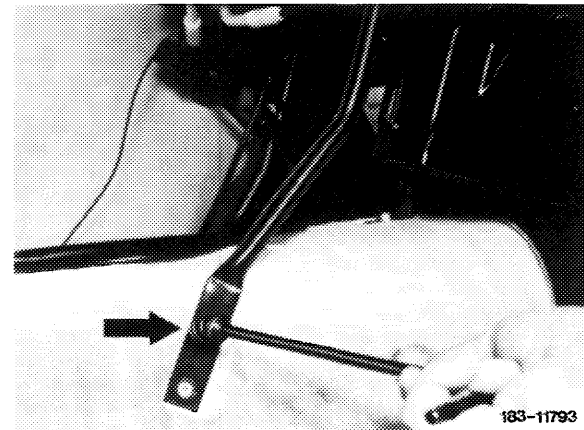

14 Unscrew screw on instrument panel.

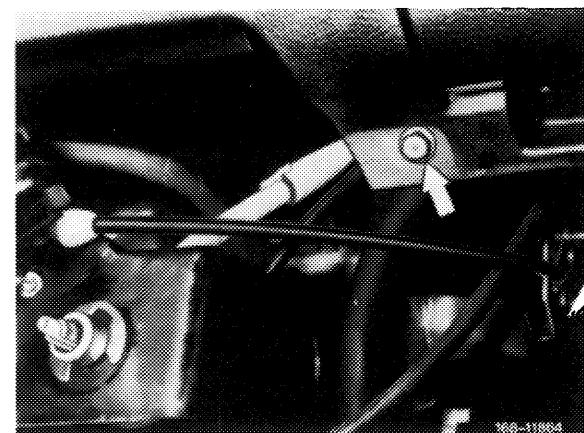

15 Remove plug and open cable clamps on heater box.

16 Loosen all electrical connections on heater box.

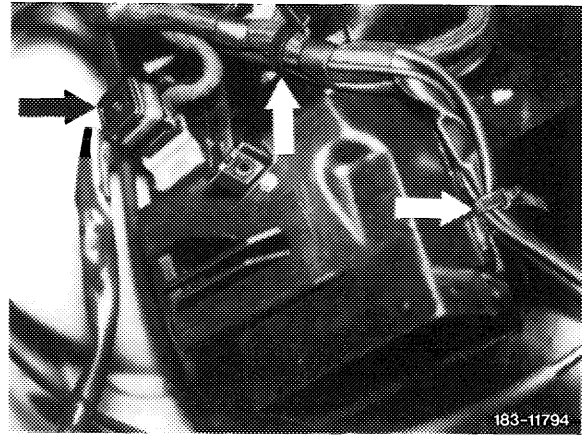

17 Disconnect bowden wires between control unit on heater box and water valve.

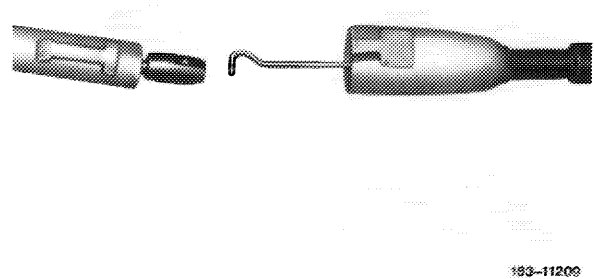

18 Disconnect bowden wire between blower switch and main air flap.

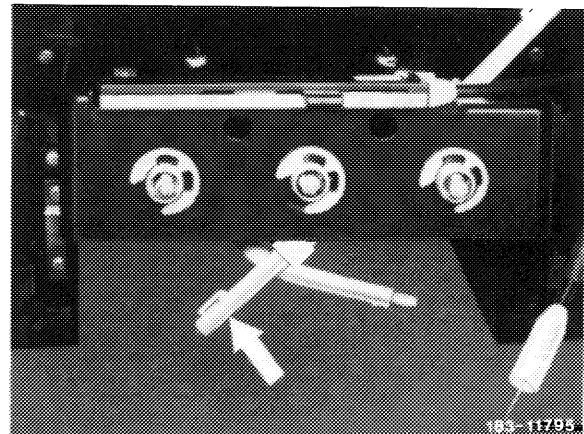

19 Unscrew nut on righthand upper angle bracket.

20 Remove plug connection from ignition starter switch.

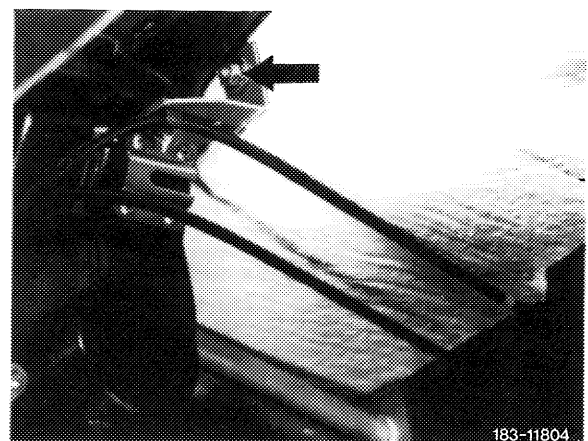

21 Unscrew nut on lefthand upper angle bracket
(do not remove instrument cluster for this purpose).

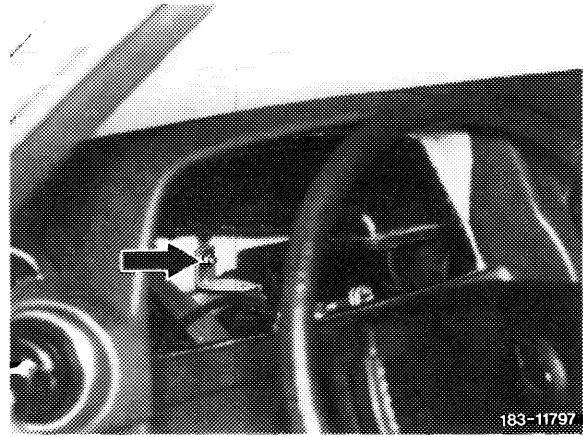

22 Unscrew both screws on lower angle bracket.

23 Close fresh air flap.

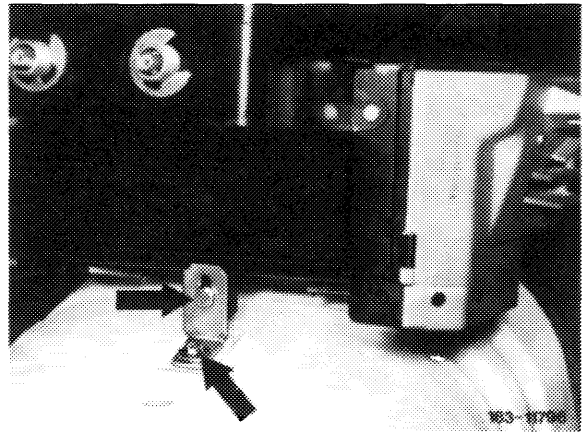

24 Lower heater box and place on transmission tunnel so that heater box slides out of defroster nozzle.

25 Pull heater box toward the rear so that the heater pipes are separated from front wall.

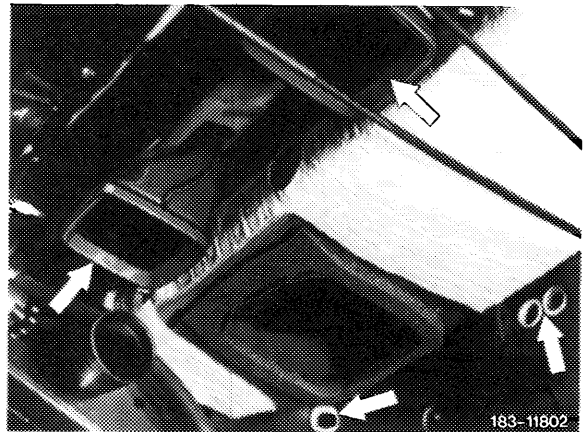

26 Lift heater box above front passenger leg room.
Hold heater pipes in upward direction so that no cooling water will flow out.

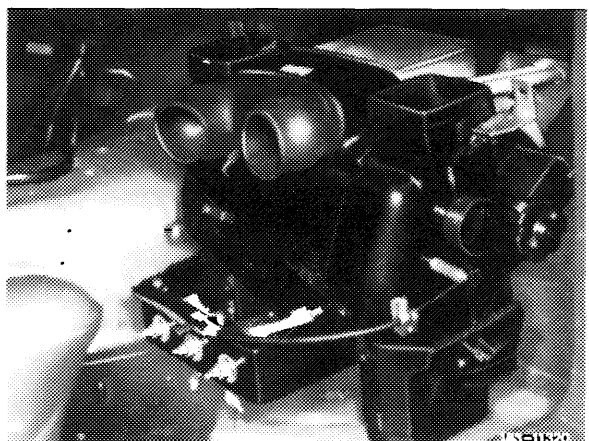

Installation

Note: During assembly jobs, do not place small parts on instrument panel, since these parts might drop through defroster nozzles into heating system.

On heater boxes 2nd version, check air flaps to leg room prior to installation and adjust for uniform closing, if required.

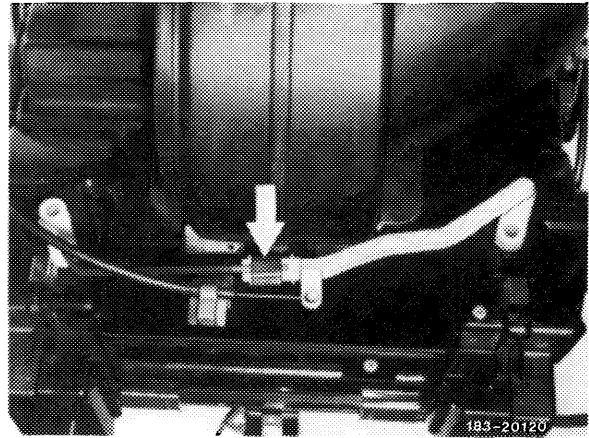

27 Lubricate rubber seal at defroster nozzles with soap water or the like.

28 Place heater box from side of front passenger behind instrument panel on transmission tunnel.

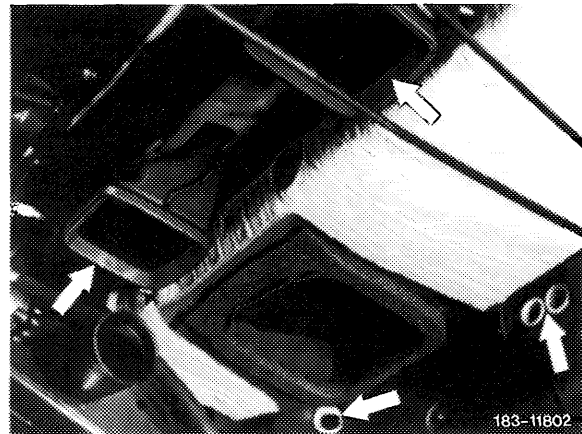

29 Tilt heater box in direction of front wall, while introducing heater pipes through front wall and into defroster nozzles.

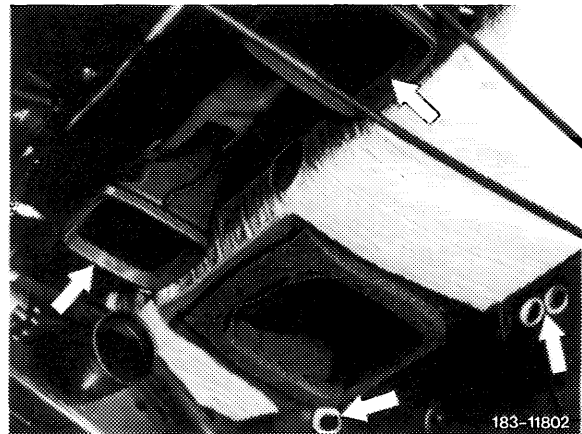

30 Attach heater box to front wall by means of lefthand upper angle bracket.

31 Attach plug connection to ignition starter switch.

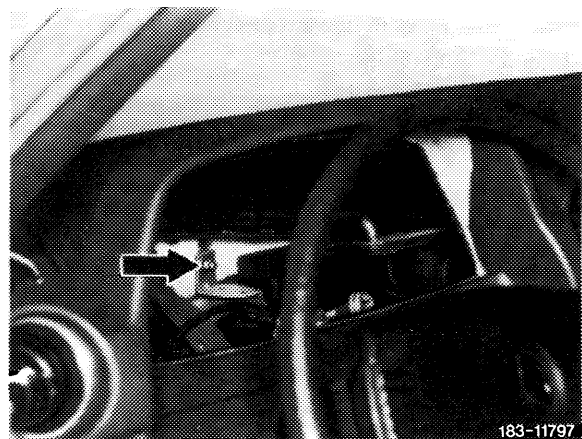

32 Attach heater box to front wall by means of righthand upper angle bracket.

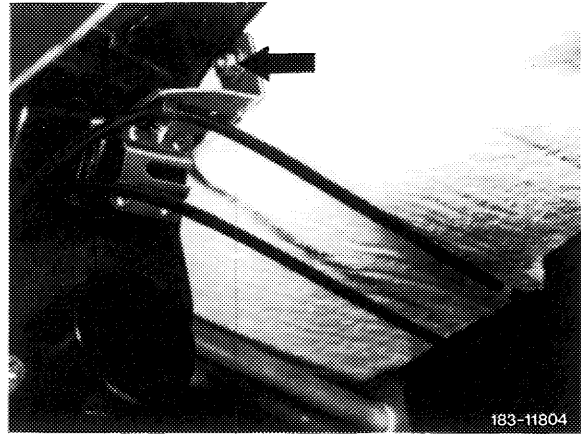

33 Install lower angle bracket in such a manner that the following dimensions are attained:

- a = 165 mm
- b = 217 mm

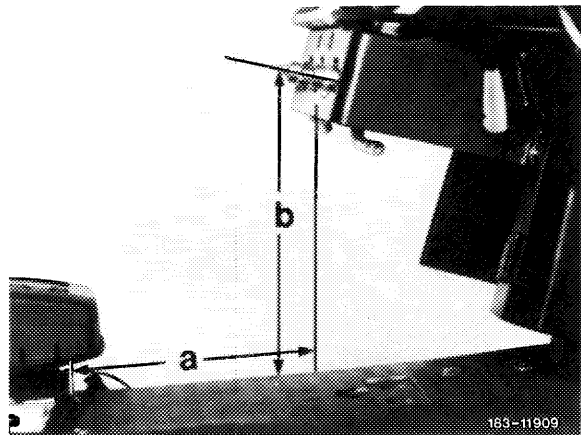

Attention!

Jobs item 34 to 36 are required only for heater box of 2nd version.

34 Attach holding straps.

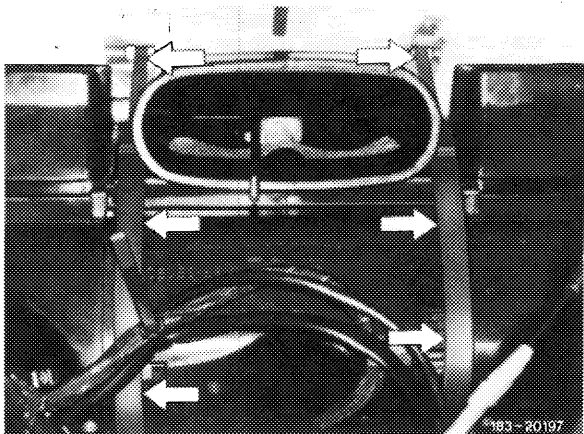

35 Screw-down holding straps under slight tension.

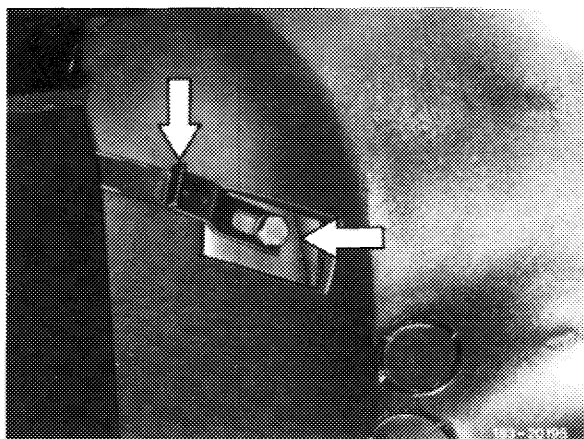

36 Mount cover on air flap levers.

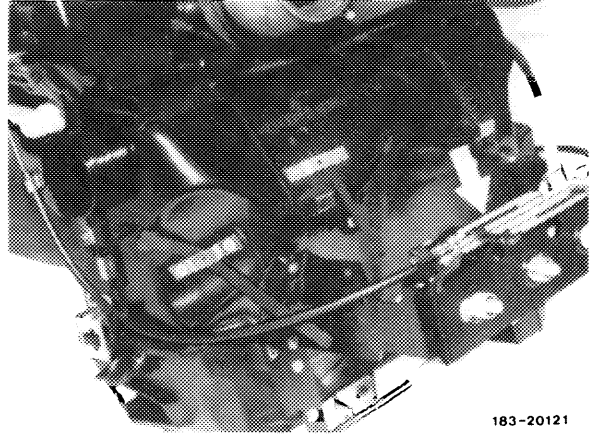

37 Connect bowden wires between control unit on heater box and water valve or main air flap.

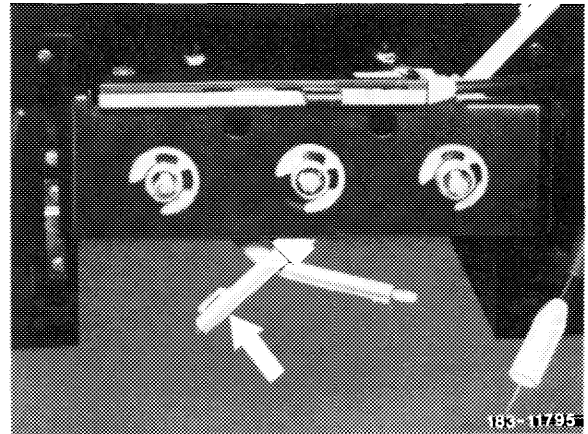

38 Check whether the main air flap opens and closes correctly. For this purpose, plug center knob to control unit and turn to the right and left up to stop.

Note: The blower housing should rest free of tension against opening in water box.

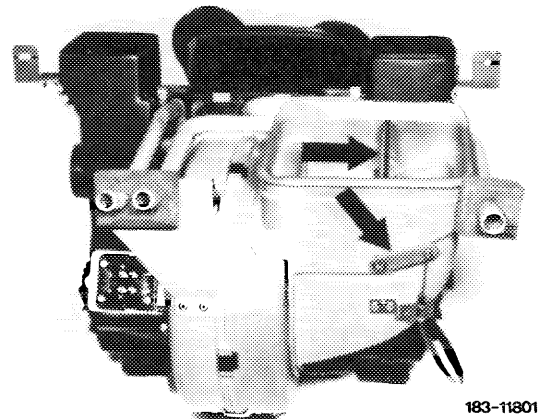

39 Mount plug to heater box.

40 Install electric cable on heater box.

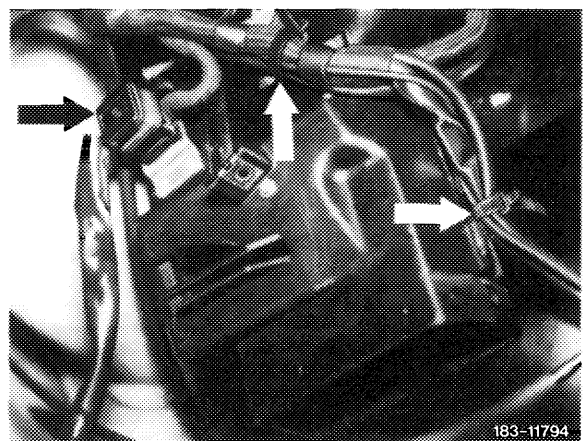

41 Install support on transmission tunnel.

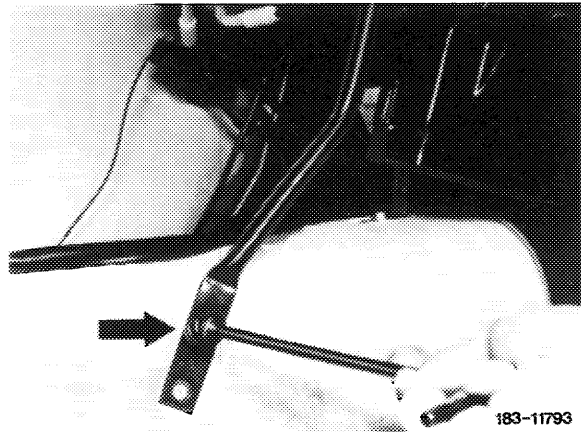

42 Install support on instrument panel.

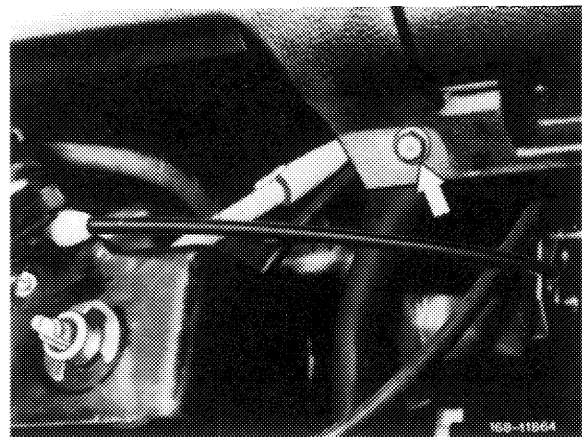

43 Attach connecting lever for fresh air nozzles.

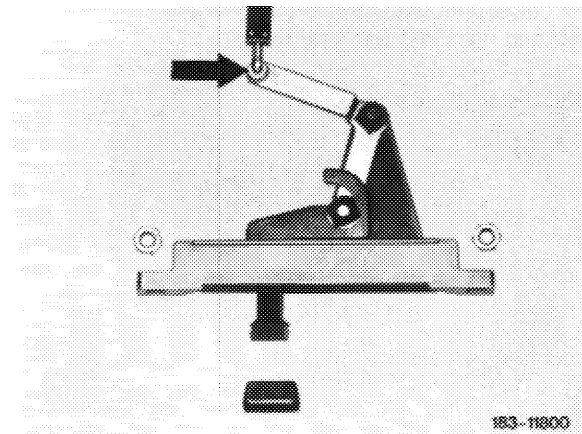

44 Check whether connecting lever is perfectly engaged.

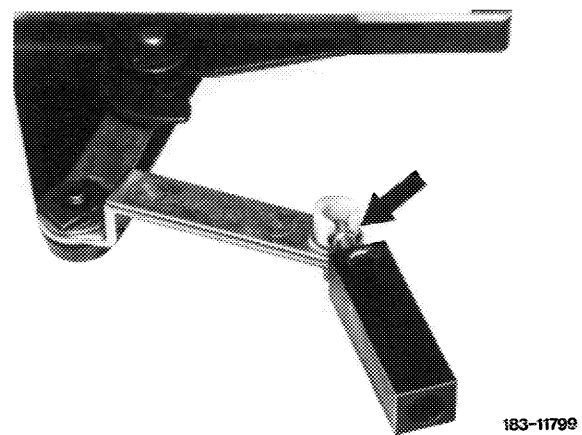

45 Mount connecting hose between heater box and the two center fresh air nozzles.

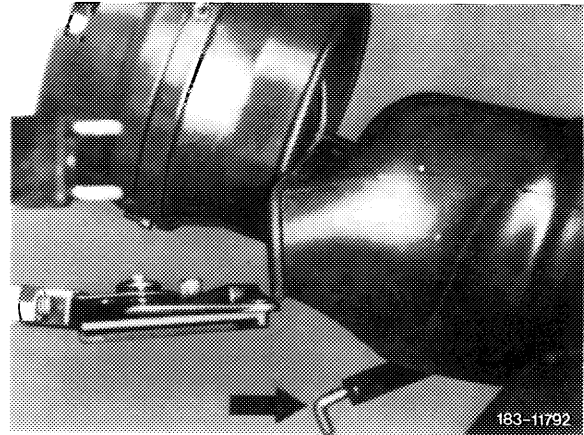

46 Attach connecting hoses to lateral ring nozzle left and right on heater box.

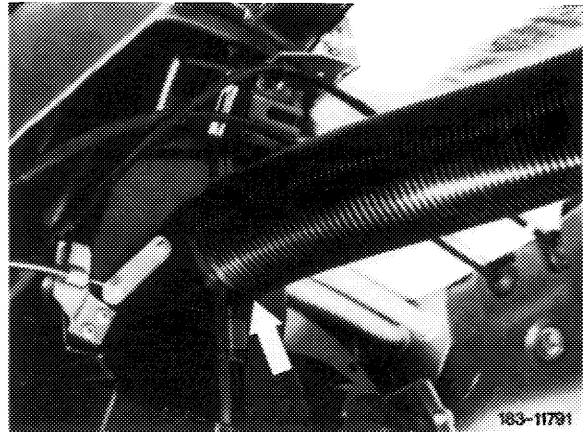

47 Mount air ducts for heating rear compartment left and right in driver's leg room.

48 Install glove box.

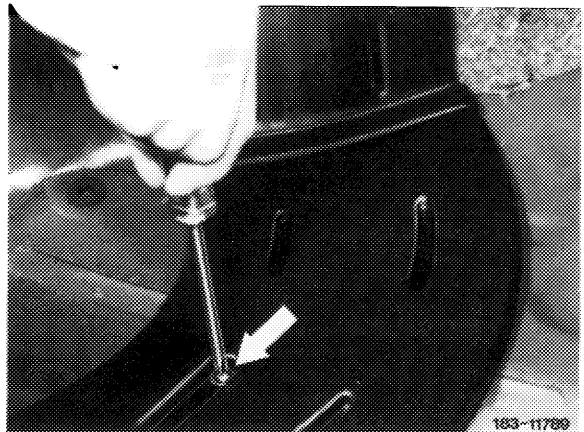

49 Mount heater hoses.

50 For further installation proceed vice versa.

