

83–536 Removal and installation of evaporator housing

Tightening torques	Nm	(kpm)
Suction hose expansion valve 7/8"	29–37	(2.9–3.7)
Pressure hose to expansion valve 5/8"	15–18	(1.5–1.8)

Note

When removing evaporator, always replace condensate drain hose (section 15 (item 22)) between evaporator housing and tunnel. Up to november 1977 install a condensate drain hose, part no. 123 832 28 94 and starting december 1977, part no. 123 832 41 94.

Remove evaporator housing together with heater box.

If the evaporator is renewed, refer to note (83–538).

Removal

- 1 Drain air-conditioning system (83–516).
- 2 Drain approx. 2 liters of coolant.
- 3 Remove driver's seats (91–100).
- 4 Remove center console (68–200).
- 5 Remove instrument panel (68–100).
- 6 Disconnect heater hoses.
- 7 Remove air ducts for rear compartment heater.

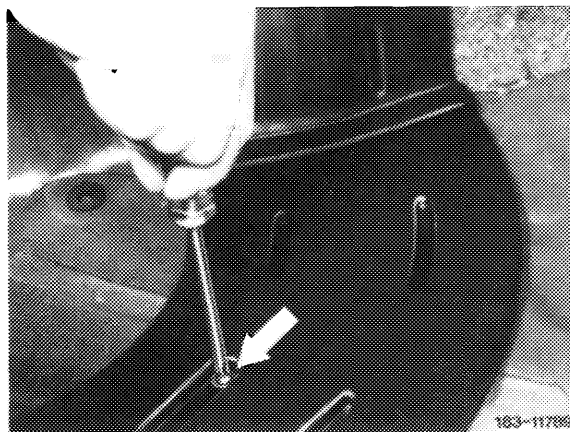
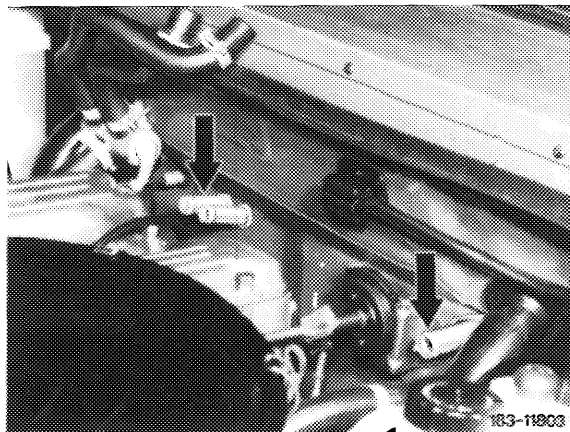

8 Remove air ducts on transmission tunnel.

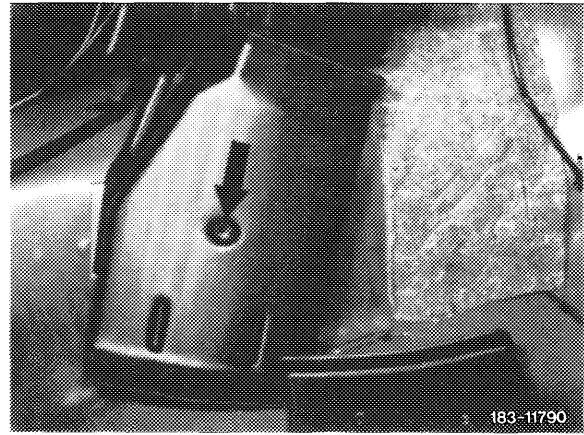

9 Pull off plug (b) and open cable bands on heater box. Loosen all electrical connections on heater box.

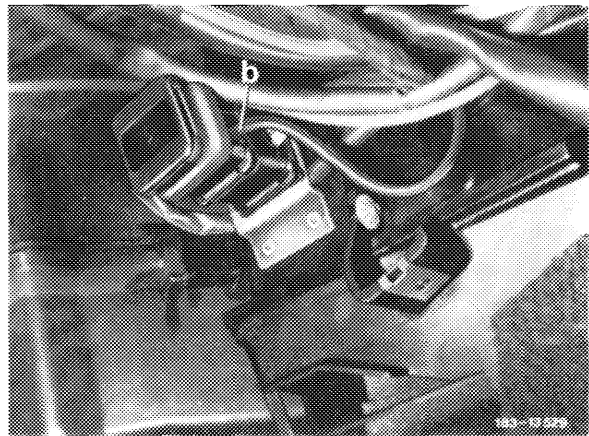

10 Separate bowden wires between operating unit on heater box and water valve.

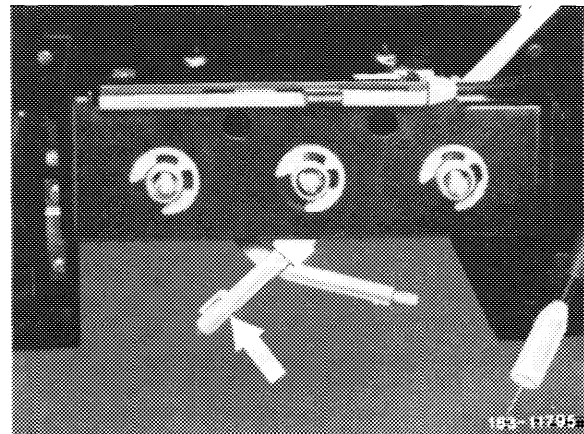

11 Force bowden wire (3) from lever of main air flap and loosen clamp (f).

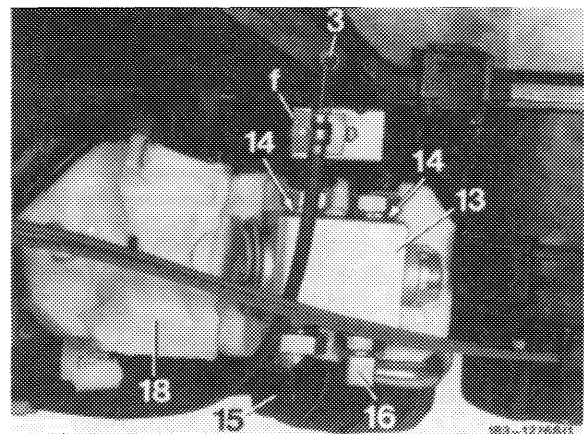

12 Remove support on transmission tunnel.

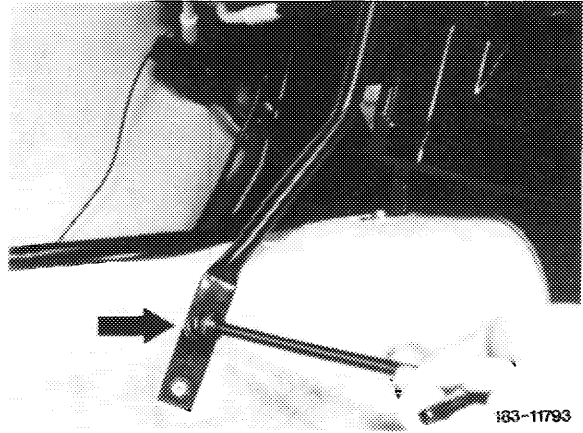

13 Unscrew refrigerant line (15 and 16) from injection valve. Then close with plug.

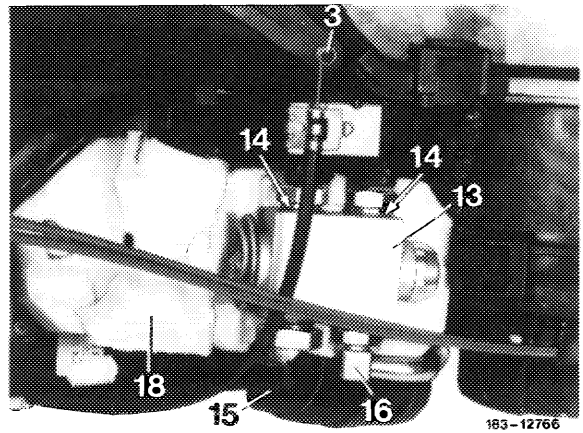

14 Pull vacuum line (26-medium green/yellow) and electric plug from temperature vacuum switch.

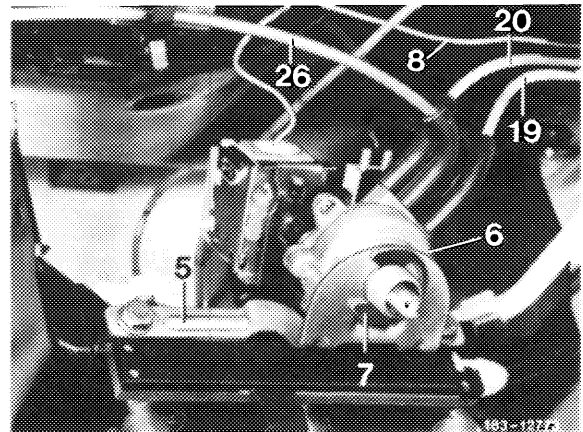

15 Loosen condensate drain hose (22) from connection of evaporator housing.

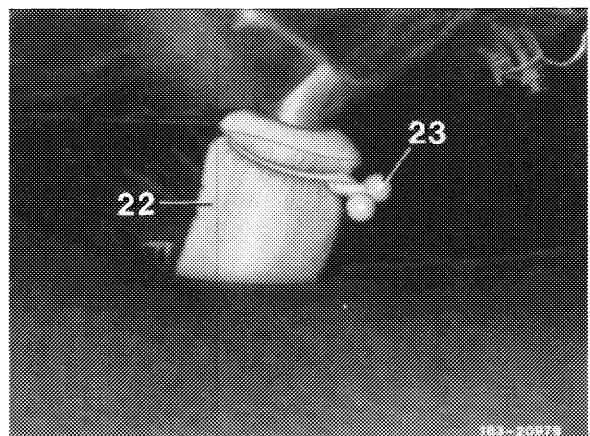

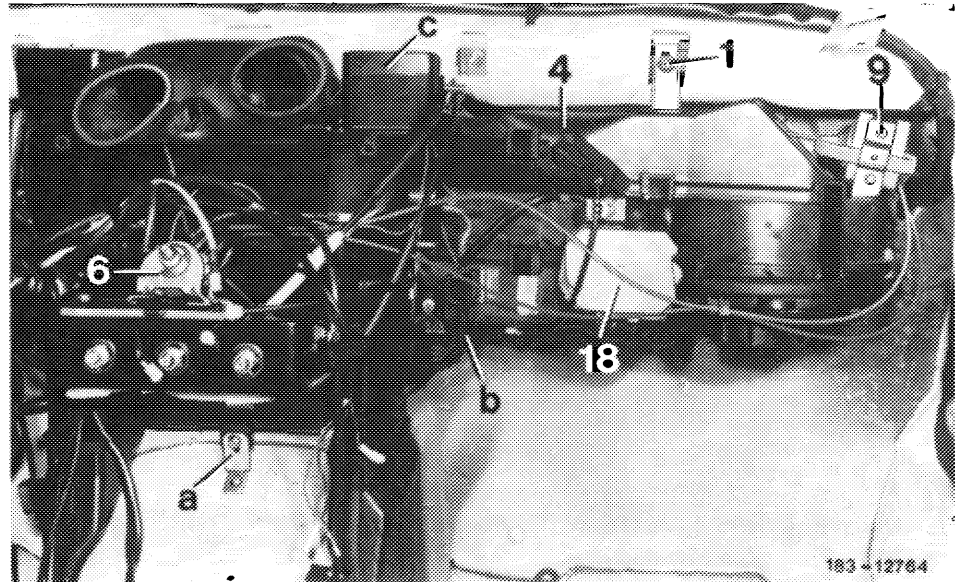

16 Unscrew nut (1) and angular fastening bracket (a).

17 Unscrew nut on righthand upper angular holding bracket.

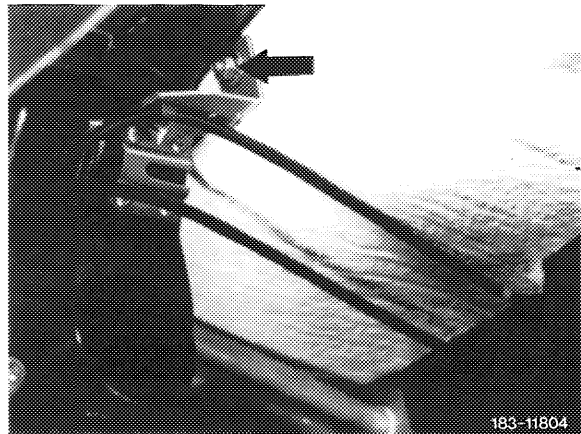

18 Unscrew nut on lefthand upper angular holding bracket.

19 Remove evaporator housing with heater box while holding heater pipes in upward direction so that no coolant will come out.

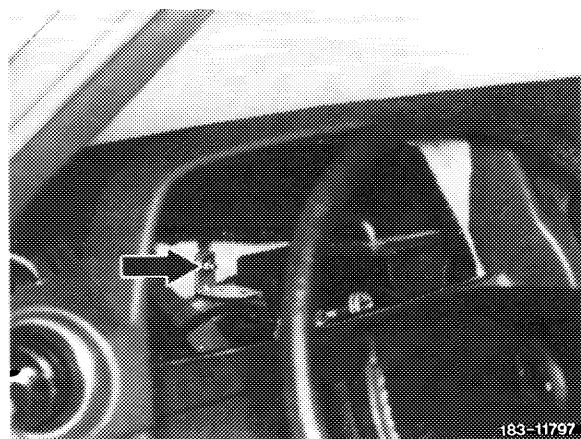

Installation

23 Flange evaporator housing to heater box.

24 On vehicles up to 07/80, insert capillary (8) of temperature regulator up to yellow mark into guide tube of evaporator or starting 08/80 insert temperature sensor in-between ribs of evaporator and mount rubber grommet in evaporator housing.

25 Plug vacuum lines (19 and 20) to vacuum element (line 19 green/orange, line 20 green/light blue).

26 Screw evaporator housing with heater box to front wall while guiding heater tubes through grommets in front wall.

27 Screw evaporator housing at top to front wall.

28 Install lower angular holding bracket in such a manner, that the following dimensions are maintained:
a = 165 mm
b = 217 mm

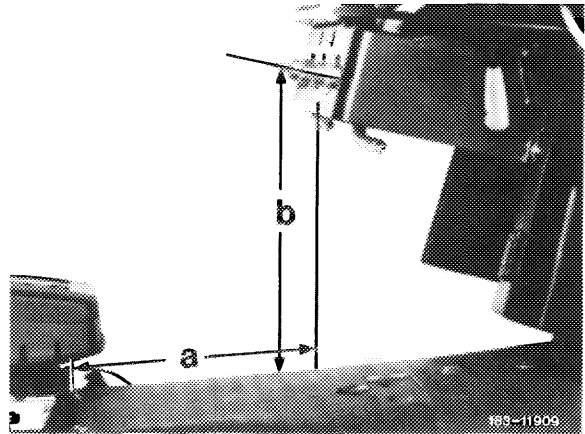

29 Mount condensate drain hoses (22 and 34).

30 Install support at transmission tunnel.

31 Connect refrigerant lines (15 and 16) to injection valve, while checking O-ring and moistening threads with cold-flowing oil.

32 Plug vacuum line (26) to temperature switch.

33 Install bowden wires, electric lines and plugs and connect.

34 Install air ducts for rear compartment heater.

35 Connect heater hoses and add coolant.

36 Install instrument panel and center console.

37 Install driver's seats.

38 Evacuate air-conditioning system, refill and check for function (83-510 to 514).

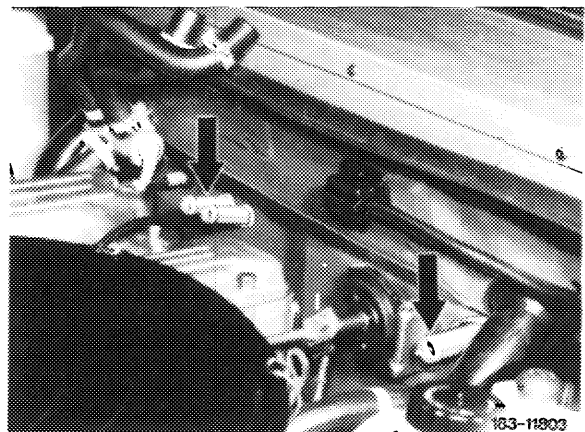
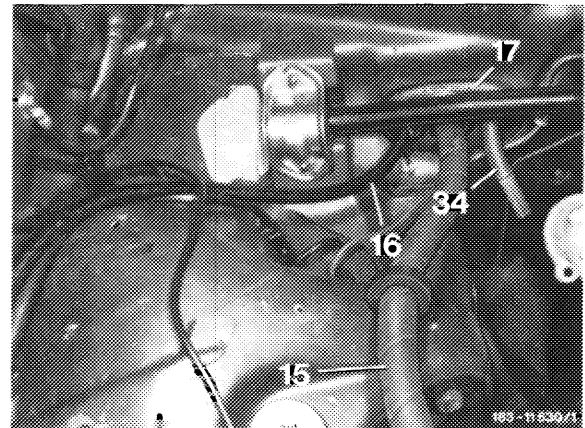

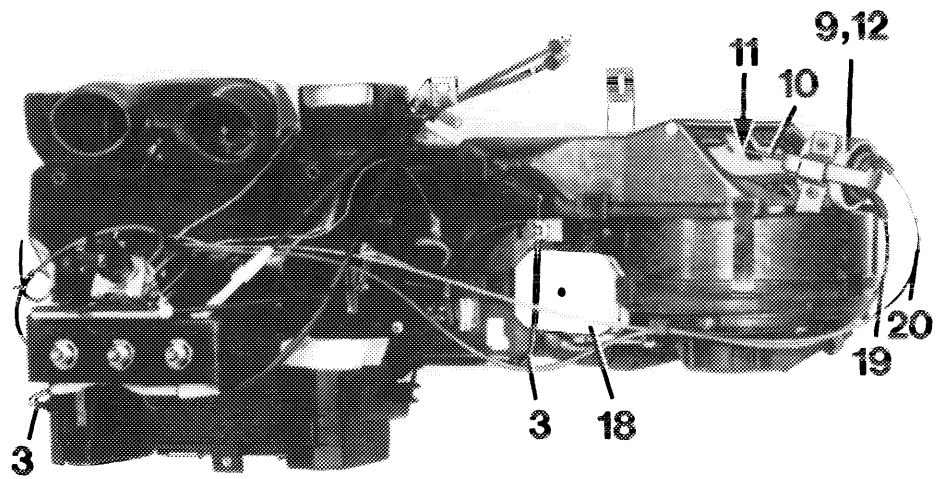

183-12763

20 Pull vacuum lines (19 and 20) from vacuum element (9).

21 On vehicles up to 07/80 pull capillary (8) of temperature switch out of guide tube in evaporator housing.

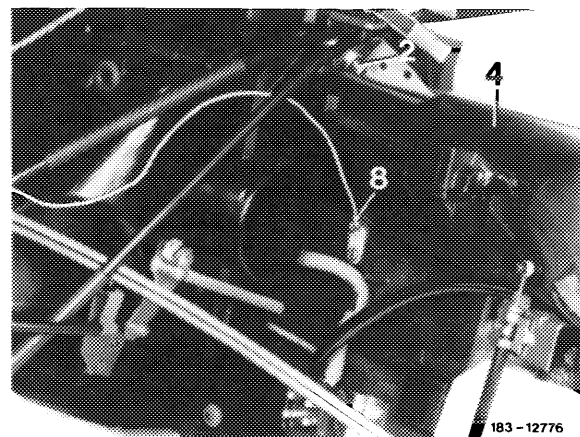

183-12776

22 Remove evaporator housing from heater box, by removing nuts (2) and clamps (b).

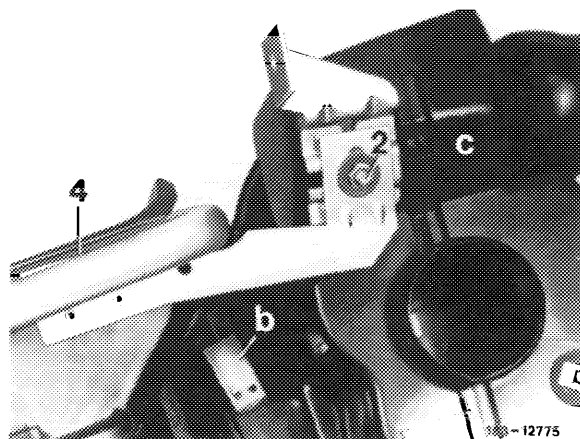

183-12775