

A. General

Models 123 can be optionally provided with a newly developed automatic climate control system instead of manual air conditioning.

The automatic climate control system regulates the desired in-car temperature. Heating, cooling and air distribution (top, center, bottom) are automatically controlled.

Automatic climate control operates only when the engine is running.

- 3 Temperature dial
- 4 Pushbutton switch with 5 functions
- 5 Blower switch

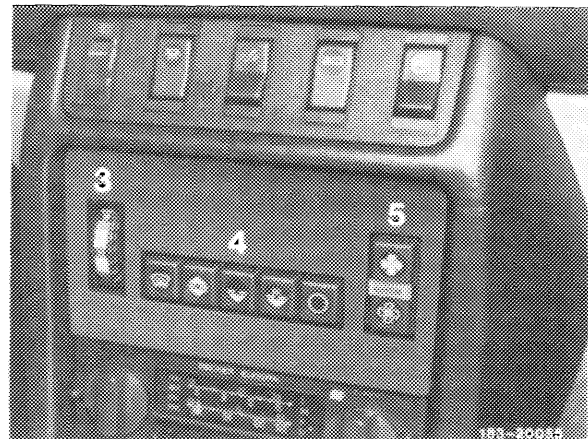

For adaptation to prevailing weather conditions, the various functions can be selected by means of push-buttons. The air inlets in center of instrument panel and the side vents can be opened, closed or swivelled as desired.

For perfect operation of automatic climate control, the manually operated air inlets in instrument panel should not be closed altogether.

Buttons should be pushed only one at a time.



B. Control unit

The control unit is located in center console and comprises a temperature dial (3), a pushbutton switch unit (4) and blower switch (5).

The temperature dial serves for stepless adjustment of in-car temperature between the two end detent positions "MIN" = not heating and "MAX" = fully heating.

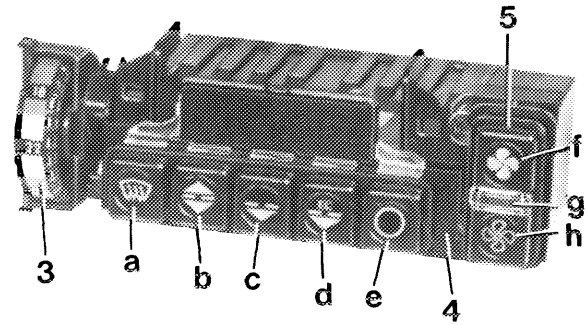

183-17660/1

Set to "MAX" means full, uncontrolled heating capacity; set to "MIN" means full, uncontrolled cooling capacity, each time in 5th blower stage. These functions apply only for pushbuttons "b" and "c", "d" for uncontrolled heating only, as well as for blower switch in position "AUTOM".

The temperature set with temperature dial is attained as quickly as possible and will then remain constant.

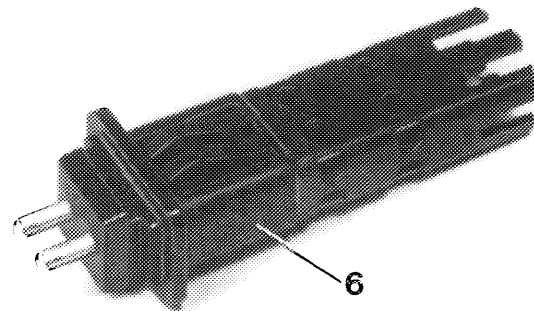

6 Temperature sensor for heat exchanger

183-17655

To prevent undesired temperature fluctuations, the temperature, once set, should be corrected in small steps only. Rotation of temperature dial will adjust a potentiometer. Together with in-car sensor (7) and sensor (6) for heat exchanger, the potentiometer provides a nominal value for temperature control.

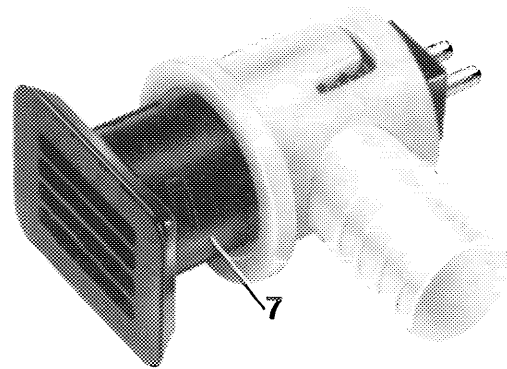

7 In-car temperature sensor

183-17657/1

The pushbutton switch unit (4) has 5 functions (a to e), the blower switch (5) has 3 (f, g, h); all are included in control unit.

The temperature dial (3) and the blower switch can be individually removed from control unit.



3 Temperature dial
4 Pushbutton switch with
5 functions
5 Blower switch

183-20053

Function selection "e" (off)

Selecting this function will switch off the air supply through main air flap into inside of vehicle (e.g. in the event of unpleasant outside dust or odors).

The electronic system continues to operate while driving and the monovalve (11) remains closed. Blower is not operating.

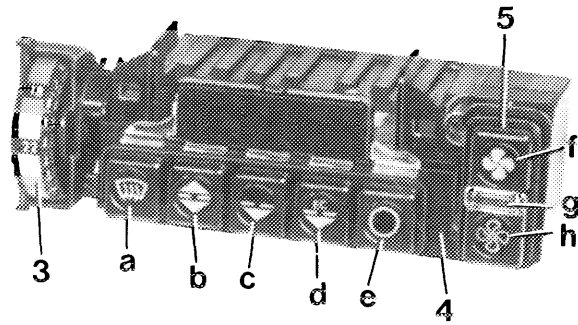

183-17660/1

Function selection "d" (cooling system off)

EC (ECONOMY = refrigerant compressor is off), system operates with fresh air only.

In heating range, tempered air will flow out of the legroom and side nozzles, with a leak air share from defroster nozzles. The windshield will be provided with just enough air to remain free of fog during normal weather conditions.

In venting range, air is routed to air inlets in center of instrument panel and to lateral vents only. The minimum in-car temperature depends on outside temperature and on solar radiation.

At low outside temperatures the air supply and the blower remain in off position until the engine is heated to approx. 35 °C by the coolant. The blower operates in stages 3 to 5 at "AUTOM".

We recommend the above function selection at outside temperatures at which no cooling of fresh air is required (to save fuel).

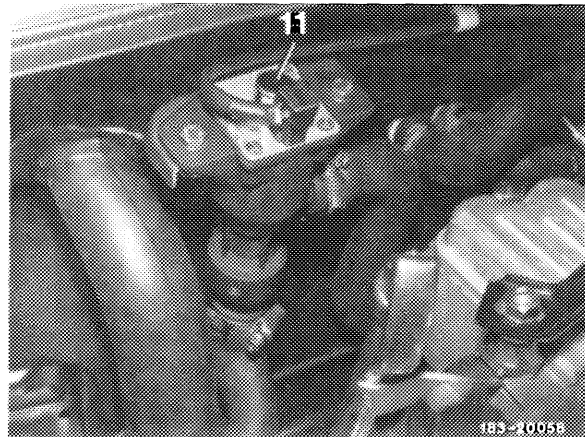

183-10058

Function selection "c" (normal adjustment)

Function selection "c" corresponds to function selection "d", with a cooling effect.

The refrigerant compressor of the air conditioning system is switched on at outside temperatures above +2 °C.

If the vehicle in-car temperature is higher by approx. 4 °C than the preselected temperature on temperature dial, the blower will start immediately. At "AUTOM" "AUTOM" the blower operates in stages 2 to 5.

In heating range, tempered air will flow out of legroom and side nozzles with a leak air share from defroster nozzle.

In cooling range, cooled air will come out of center and side jets only. The mode changes operate automatically, overlapping is possible, that is, legroom and center nozzles can be open simultaneously.

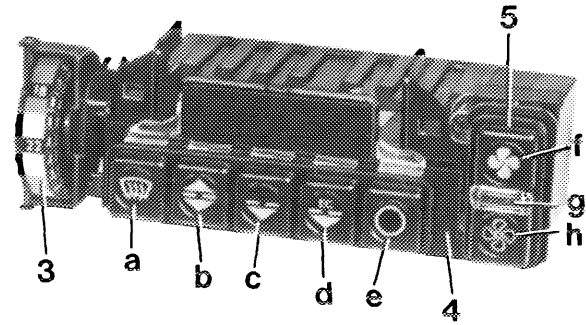

183-17660/1

The compressor is added, at outside temperatures above + 2 °C, the evaporator temperature is held to approx. 0 °C. If the system moves to "cooling", the fresh air/recirculating air flap is automatically switched to recirculating air.



183-2005*

- 3 Temperature dial
- 4 Pushbutton switch unit with 5 functions
- 5 Blower switch with 3 functions

Function selection "b" (top and bottom)

The blower starts after approx. 10 sec., also below 35 °C coolant temperature, in position "AUTOM" in stages 3 to 5.

In heating range, air is routed to windshield, to side vents and to legroom; in cooling range additionally to air inlets in center of instrument panel.

The interior of the vehicle is extensively free of draft – the legroom is cooled more intensively. This function serves the purpose of removing fog, if any, on glass during damp, cold weather conditions.

The refrigerator compressor is switched on at outside temperatures above + 2 °C.

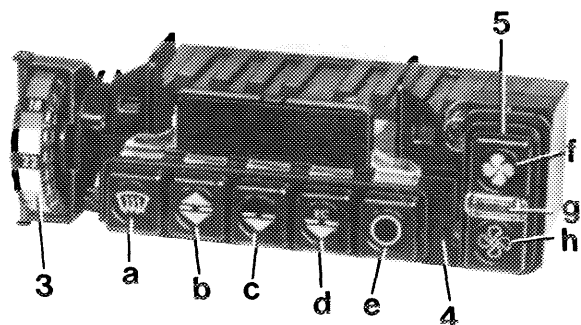

- 3 Temperature dial
- 4 Pushbutton switch unit with 5 functions
- 5 Blower switch with 3 functions

183-17660/1

Function selection "a" (defrosting)

With the ignition switched on, the blower will start immediately and operate in 6th blower stage only.

Independent of temperature dial adjustment, max. heated air will be routed to windshield.

The recirculating pump is always running along and the refrigerant compressor is switched on at outside temperatures above + 2 °C. If, with the ignition switched on, function selection "a" or "b" is pushed followed by switching to "c" or "d", the system remains in operation also below 35 °C coolant temperature.

Blower switch (5)

The blower operates in 6 stages.

At function selection "b", "c" and "d" the air volume can be set as required.

Switch	Air volume	Blower stage
f (top)	max.	6 (12 V)
h (bottom)	min.	1 (4 V)
g (center)	automatic	2-5 (5-10 V)

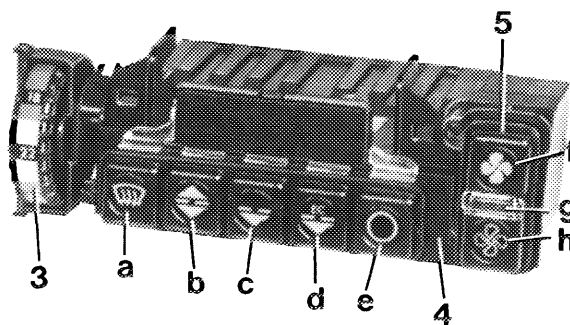

183-17660/1

During "AUTOM" operation in functions "b, c and d" the blower will start in 2nd blower stage after the system has been switched on with a delay of approx. 10 seconds, and remains constant for approx. 10 seconds (on vehicles up to December 1980 approx. 30 seconds). If required, the blower will switch up to 5th blower stage.

C. Temperature sensor

The in-car temperature sensor (7) is located under a grille at top in instrument panel. The sensor feels the in-car temperature and transmits that temperature to the electronic switch gear (9) to balance the temperature as set.

Layout of in-car temperature sensor on instrument panel
7 In-car temperature sensor

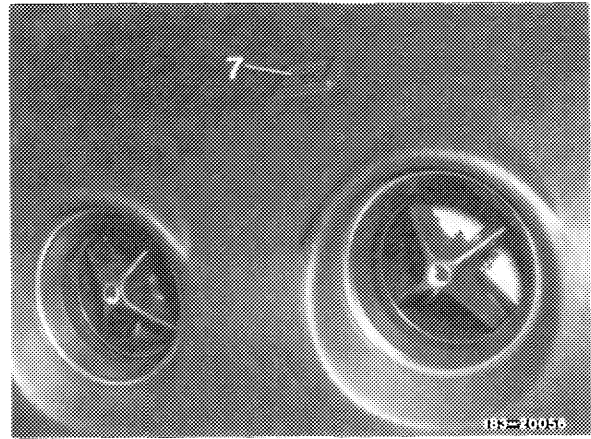

An air jet (47) attached to blower housing will draw air from interior of vehicle by way of the in-car temperature sensor, while the blower is running. As a result, the response period of the sensor is shortened and the control accuracy is increased.

47 Air jet

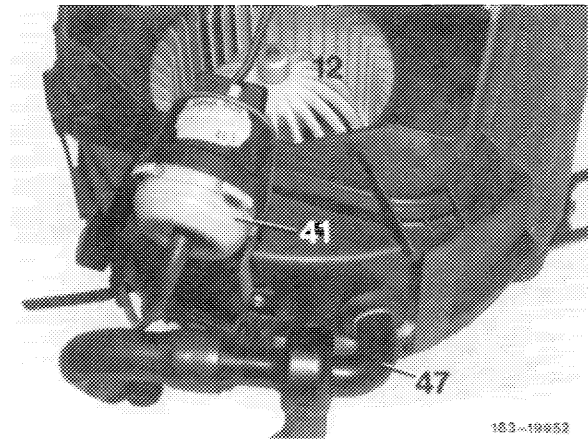

The temperature sensor (6) for heat exchanger is located in housing for heat exchanger and transmits its resistance to the electronic switching unit for temperature control.

6 Temperature sensor for heat exchanger

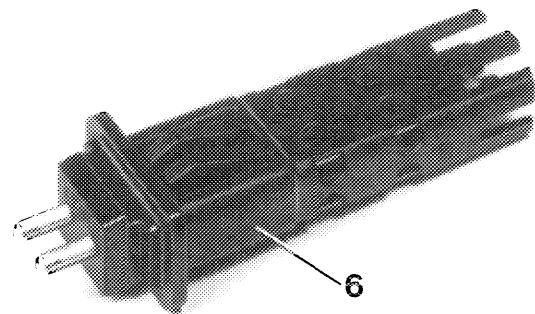

Layout of temperature sensor (6) for heat exchanger

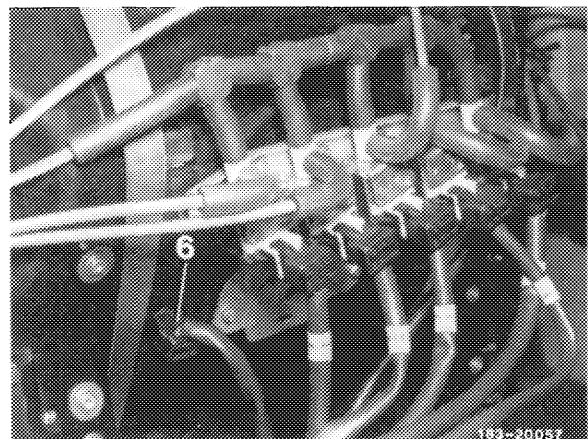

D. Monovalve with check valve, electric recirculating pump and cold engine lock

The monovalve (11) controls the flow rate of the coolant in heat exchanger and comprises a magnetic valve, which is provided with plus directly from fuse element and is connected to ground in control range by electronic switching unit in a 5-second cycle. Without ground connection the valve is always open, if ground is connected, the valve is completely closed. Opening and closing times are activated by the electronic switching unit for temperature control and depend on the deviation from actual and desired temperature.

The installed check valve (arrow) in lower housing section of monovalve makes sure that the heat exchanger is not filled with hot coolant when the engine is stopped (monovalve "open").

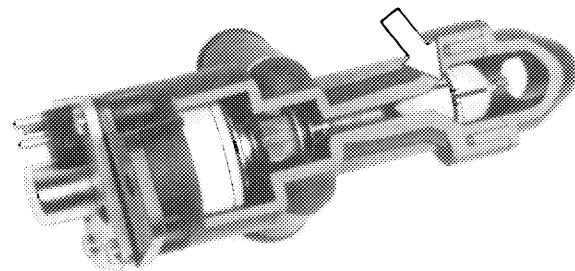

Monovalve

183 - 22101

The recirculating pump (30) at front right in engine compartment serves to maintain a uniform coolant flow through heat exchanger even at low engine speeds (Fig.). During controlled operation, the pump is switched on by the signal "legroom nozzles open".

Electric activation is by way of control unit.

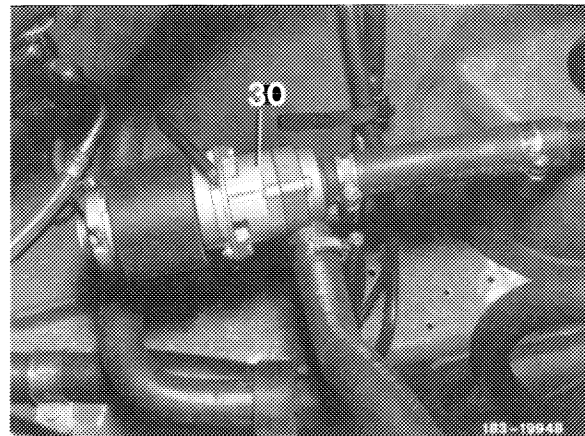

30 Layout of recirculating pump front right in engine compartment

183 - 19949

The temperature switch (2) (cold engine lock) prevents the system from starting at a coolant temperature below 33 °C in functions "c" and "d" and thereby guarantees that no undesired, cold air is blown against passengers.

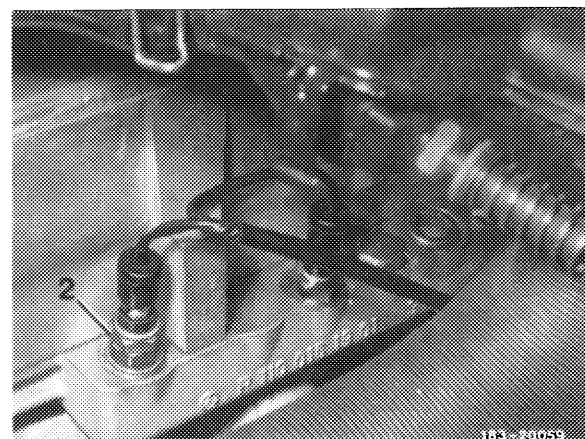

2 Layout of temperature switch (cold engine lock) engine 110

183 - 19959

2 Layout of temperature switch
(cold engine lock) with diesel engines

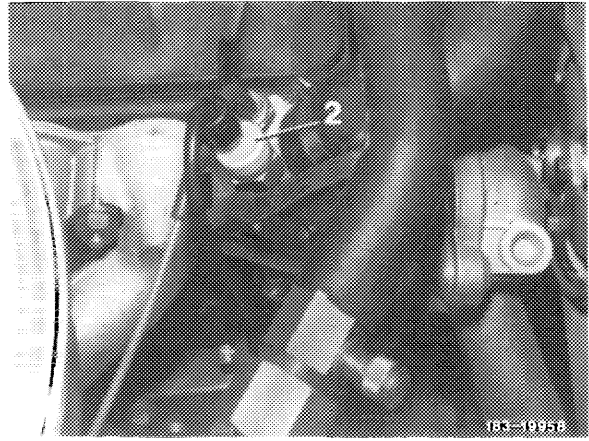

2 Layout of temperature switch
(cold engine lock) engine 102

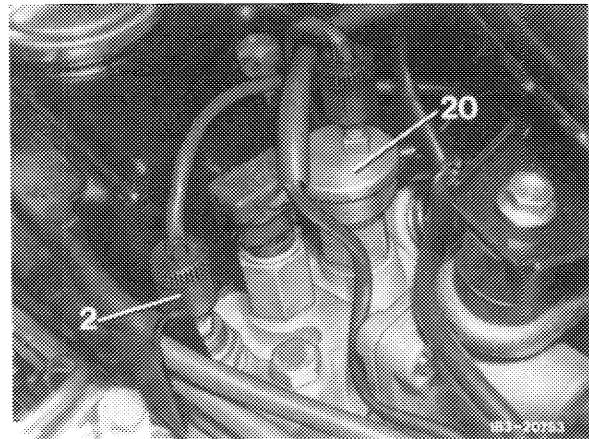

E. Electronic switching unit for temperature and blower control with electric wiring diagram

The resistance values of the in-car temperature sensor, the temperature sensor for heat exchanger and the nominal value potentiometer (temperature dial) are processed in electronic switching unit for temperature control.

Switching unit (9) for temperature control regulates according to requirements:

- a) Flow through heat exchanger via monovalve,
- b) change of mode, that is, switching from "cooling" to "heating" and vice versa, during which in accordance with pertinent in-car temperature conditions, tempered air may simultaneously flow out of legroom nozzles as well as out of center nozzles (overlap),
- c) position of fresh air – recirculating air flap,
- d) control of blower stages via pre-resistance group (1) by means of switching unit for blower control (19).

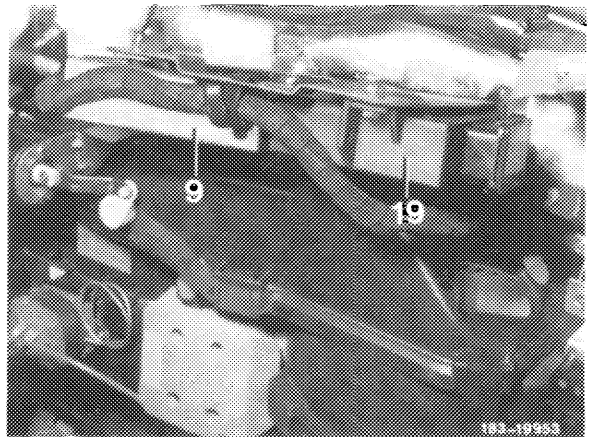
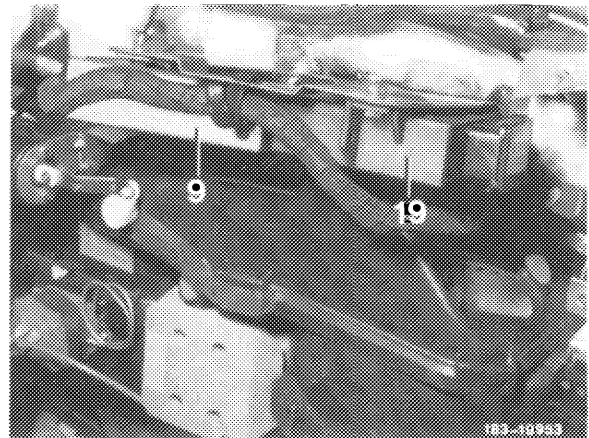

9 Electronic control unit for temperature control
19 Electronic switching unit for blower control

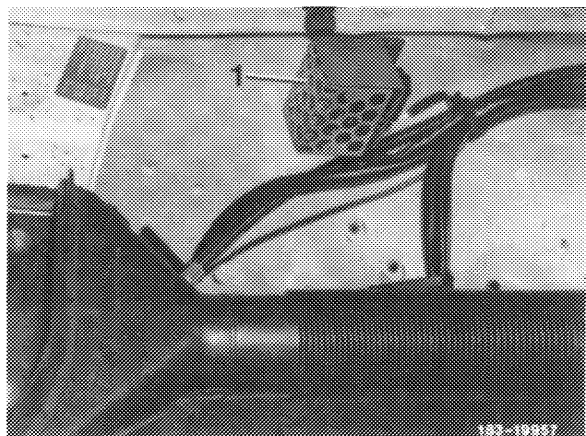

1 Pre-resistance group for blower at wheelhouse, right

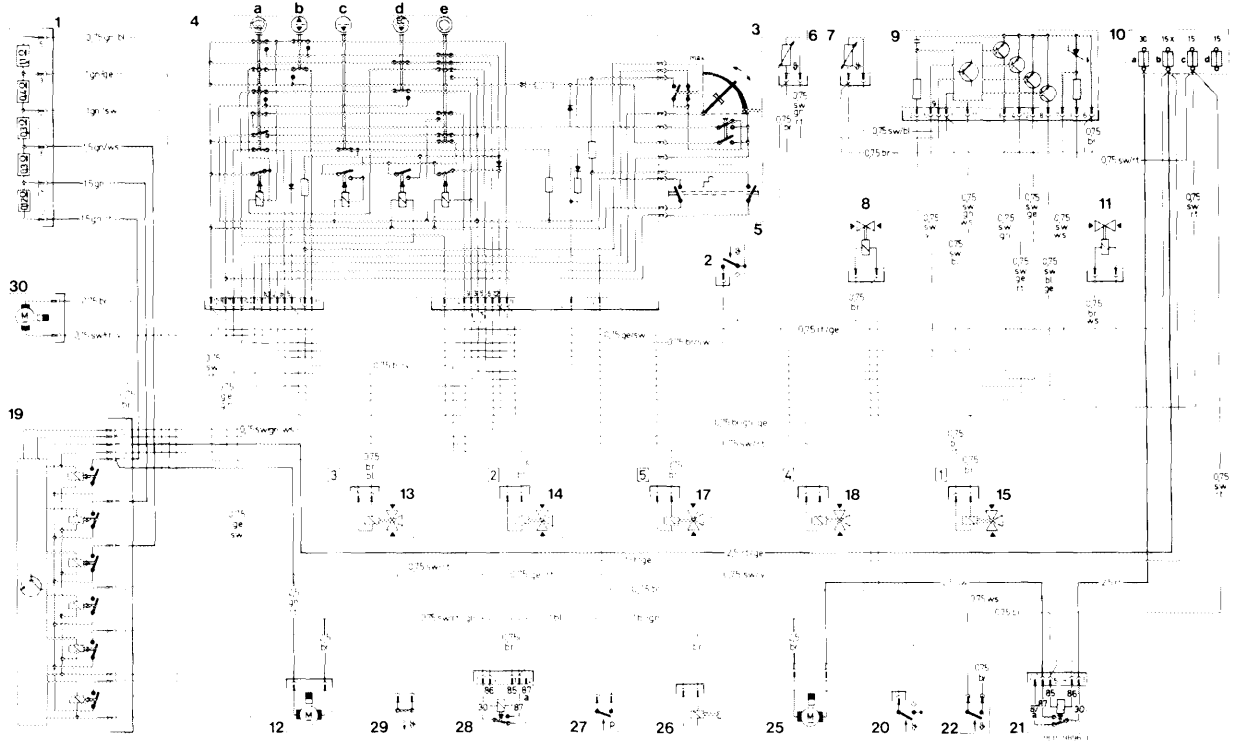

Model 123.0, 123.1

Electric wiring diagram automatic climate control

- | | |
|---|--|
| <ul style="list-style-type: none"> 1 Pre-resistance group 2 Temperature switch (cold engine lock) 3 Temperature dial 4 Pushbutton switch unit <ul style="list-style-type: none"> a Defrosting b Top and bottom (also legroom) c Normal adjustment (air conditioning on) d EC (air conditioning off) e Off 5 Blower switch 6 Temperature sensor for heat exchanger 7 In-car temperature sensor 8 Switchover valve for rpm stabilization (except 123.1) 9 Electronic switching unit for temperature control 10 Fuse box <ul style="list-style-type: none"> a Fuse C: 16 amps. b Fuse 8: 16 amps. c Fuse 14: 8 amps. | <ul style="list-style-type: none"> 11 Monovalve 12 Blower motor 13 Switchover valve for center nozzle flap 14 Switchover valve for legroom flaps 15 Switchover valve for defroster nozzle flaps 17 Switchover valve for main air flap 18 Switchover valve for fresh air-recirculating air flap 19 Electronic switching unit for blower control 20 Temperature switch 100 °C for additional fan 21 Relay additional fan (code number 6) 22 Temperature switch 52 °C for additional fan 25 Additional fan 26 Electromagnetic coupling-refrigerant compressor 27 Low pressure switch refrigerant compressor 28 Relay refrigerant compressor (code number 12) 29 ETR-switch 30 Recirculating pump |
|---|--|

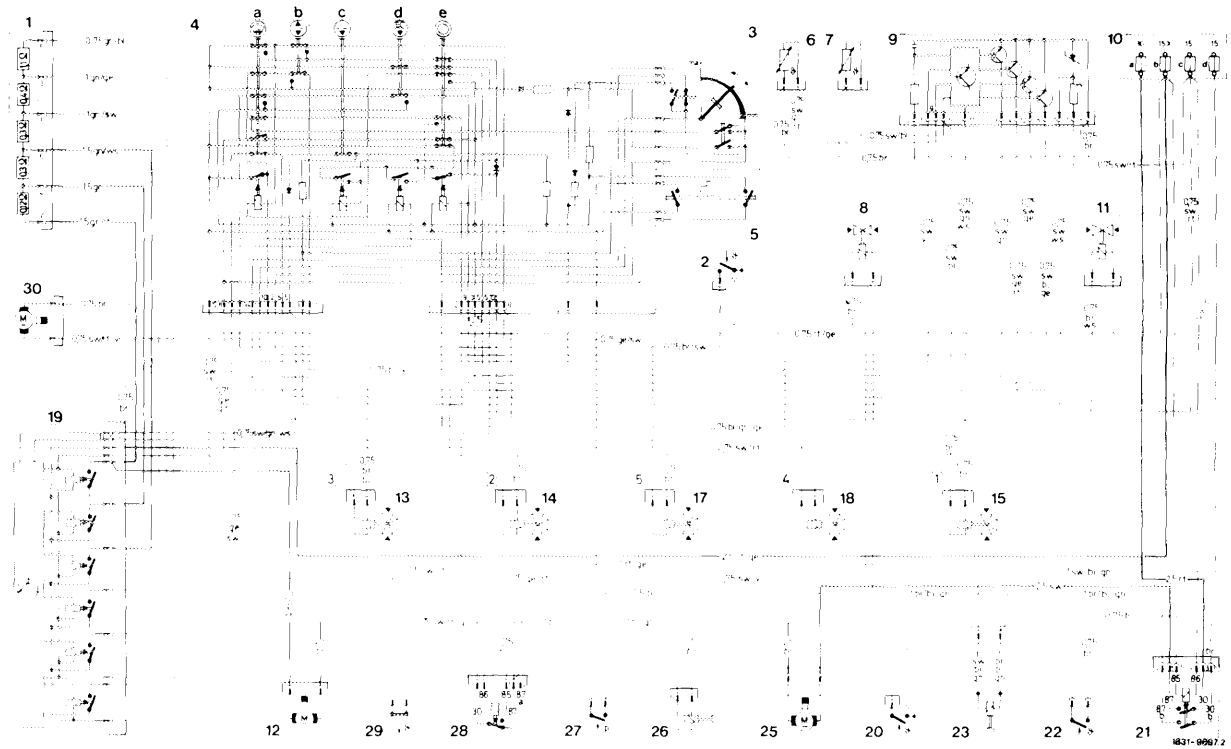

Model 123.2

Electric wiring diagram automatic climate control

- 1 Pre-resistance group
- 2 Temperature switch (cold engine lock)
- 3 Temperature dial
- 4 Pushbutton switch unit
 - a Defrosting
 - b Top and bottom (also legroom)
 - c Normal adjustment (air conditioning on)
 - d EC (air conditioning off)
 - e Off
- 5 Blower switch
- 6 Temperature sensor for heat exchanger
- 7 In-car temperature sensor
- 8 Switchover valve for rpm stabilization
- 9 Electronic switching unit for temperature control
- 10 Fuse box
 - a Fuse C: 16 amps.
 - b Fuse 8: 16 amps.
 - c Fuse 14: 8 amps.
 - d Fuse 10: 16 amps.
- 11 Monovalve
- 12 Blower motor
- 13 Switchover valve for center nozzle flap
- 14 Switchover valve legroom flaps
- 15 Switchover valve defroster nozzle flaps
- 17 Switchover valve for main air flap
- 18 Switchover valve for fresh air-recirculating air flap
- 19 Electronic switching unit for blower control
- 20 Temperature switch 100 °C for additional fan
- 21 Relay additional fan and magnetic clutch (code number 6a)
- 22 Temperature switch 52 °C for auxiliary fan
- 23 Magnetic coupler for fan
- 25 Additional fan
- 26 Electromagnetic coupling-refrigerant compressor
- 27 Low pressure switch refrigerant compressor
- 28 Relay refrigerant compressor (code number 12)
- 29 ETR-switch
- 30 Recirculating pump

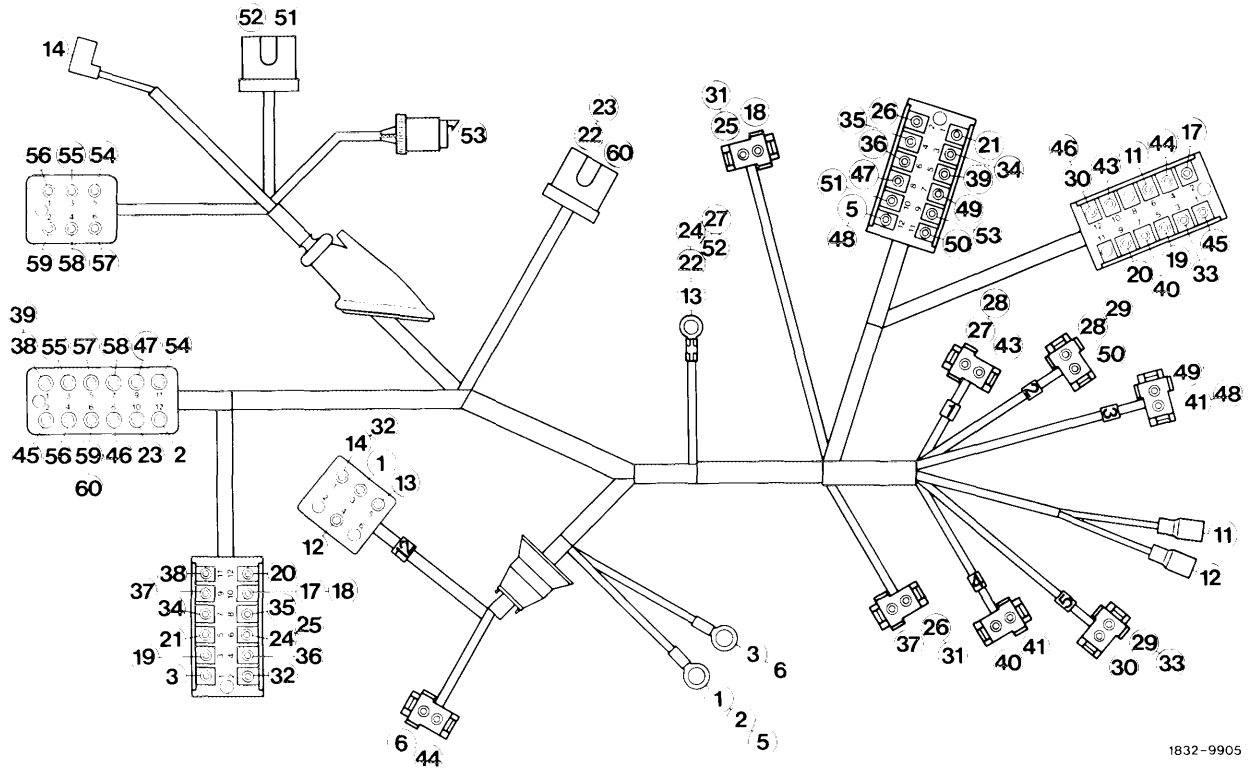

1832-9905

Color code of additional harness

Line no.	Electric line from	to	Color code	Cross section mm ²
1	Fuse 8 terminal 15 X	Relay refrigerant compressor terminal 30	red/yellow	1.0
2	Fuse 8 terminal 15 X	Switching unit blower terminal 12	red/yellow	2.5
3	Fuse 10 terminal 15	Switching unit temperature control terminal 1	black/red	0.75
5	Fuse 8 terminal 15 X	Pushbutton switch left terminal 12	red/yellow	0.75
6	Fuse 10 terminal 15	Monovalve	black/red	0.75
11	Pushbutton switch right terminal 6	EGR-switch	black/red	0.75
12	ETR-switch	Relay refrigerant compressor terminal 86	black/red/green	0.75
13	Ground	Relay refrigerant compressor terminal 85	brown	0.75
14	Relay refrigerant compressor terminal 87	Pushbutton switch	blue	1.0
17	Pushbutton switch right terminal 2	Switching unit temperature control terminal 10	black/blue	0.75
18	Switching unit temperature control terminal 10	In-car temperature sensor	black/blue	0.75
19	Switching unit temperature control terminal 3	Pushbutton switch right terminal 5	black/green	0.75
20	Switching unit temperature control terminal 12	Pushbutton switch right terminal 9	black/yellow	0.75
21	Switching unit temperature control terminal 5	Pushbutton switch left terminal 1	black/purple	0.75
22	Ground	Blower motor	brown	2.5
23	Blower motor (ground)	Switching unit blower terminal 10	brown	0.75
24	Ground	Switching unit temperature control terminal 6	brown	0.75
25	Switching unit temperature control terminal 6	In-car temperature sensor	brown	0.75
26	Temperature sensor heat exchanger	Pushbutton switch left terminal 2	brown	0.75
27	Ground	Switchover valve 1	brown	0.75

Color code of additional harness (ctd.)

Line no.	Electric line from	to	Color code	Cross section mm ²
28	Switchover valve 1	Switchover valve 2	brown	0.75
29	Switchover valve 2	Switchover valve 5	brown	0.75
30	Pushbutton switch right terminal 12	Switchover valve terminal 5	yellow/black	0.75
31	In-car temperature sensor	Temperature sensor heat exchanger	brown	0.75
32	Control unit terminal 2	Relay refrigerant compressor terminal 87	blue	0.75
33	Switchover valve 6	Pushbutton switch right terminal 3	brown	0.75
34	Switchover unit temperature control terminal 7	Pushbutton switch left terminal 3	black/white	0.75
35	Switching unit temperature control terminal 8	Pushbutton switch left terminal 4	black/blue/yellow	0.75
36	Switching unit temperature control terminal 4	Pushbutton switch left terminal 6	black/yellow/red	0.75
37	Switching unit temperature control terminal 9	Temperature sensor heat exchanger	black/green/red	0.75
38	Switching unit temperature control terminal 11	Switching unit blower terminal 1	black/green/white	0.75
39	Switching unit blower terminal 1	Pushbutton switch left terminal 5	black/green/white	0.75
40	Pushbutton switch right terminal 7	Switchover valve 5	blue/green/yellow	0.75
41	Switchover valve terminal 3	Switchover valve terminal 4	black/red	0.75
43	Pushbutton switch right terminal 10	Switchover valve 1	blue/red	0.75
44	Pushbutton switch right terminal 4	Heating water valve	brown/white	0.75
45	Pushbutton switch right terminal 1	Switching unit blower terminal 2	yellow/red	0.75
46	Pushbutton switch right terminal 12	Switching unit blower terminal 8	yellow/black	0.75
47	Pushbutton switch left terminal 8	Switching unit blower terminal 9	yellow/green	0.75
48	Pushbutton switch left terminal 12	Switchover valve 3	black/red	0.75
49	Pushbutton switch left terminal 7	Switchover valve 3	brown/blue	0.75
50	Pushbutton switch left terminal 11	Switchover valve 2	blue/purple	0.75
51	Pushbutton switch left terminal 10	Recirculating pump	black/red/purple	0.75
52	Ground	Recirculating pump	brown	0.75
53	Pushbutton switch left terminal 9	Cold engine lock	brown/black	0.75
54	Switching unit blower terminal 11	Resistance group stage 1 terminal 5	green/blue	0.75
55	Switching unit blower terminal 3	Resistance group stage 2 terminal 3	green/yellow	0.75
56	Switching unit blower terminal 4	Resistance group stage 3 terminal 1	green/black	1.0
57	Switching unit blower terminal 5	Resistance group stage 4 terminal 6	green/white	1.5
58	Switching unit blower terminal 7	Resistance group stage 5 terminal 4	green	1.5
59	Switching unit blower terminal 6	Resistance group stage 6 terminal 2	green/red	1.5
60	Switching unit blower terminal 6	Blower motor	green/red	2.5

F. Air path and control of air flaps with vacuum function diagram

The fresh air inlet openings are located at left and right in front of windshield.

The spent air from inside vehicle is routed through openings in rear pillars at left and right.

The main air flap (arrow, position "open"), as well as the fresh air recirculating flap (arrow, position "fresh air") are located in evaporator housing (also refer to 600/17).

Main air flap (arrow)

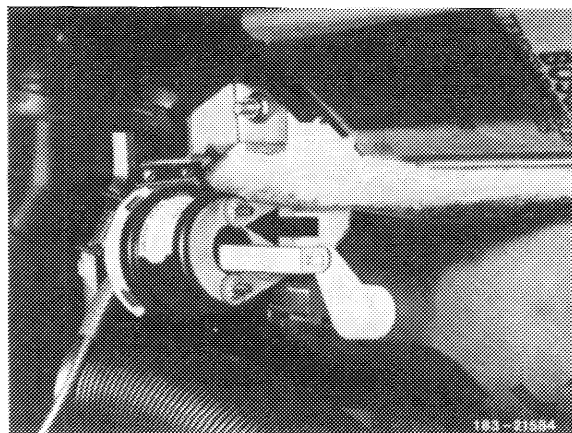

The flaps for controlling the air outlets in passenger compartment, such as air to windshield, center nozzles and to legroom, are located in air conditioning cabinet.

Fresh air/recirculating air flap (arrow)



The air outlets at left and right for lateral venting can be opened or closed manually only. In center, the center nozzle flap is automatically opened or closed. In addition, manual opening and closing is performed by turning the inserts.

Center nozzle flap (arrow)

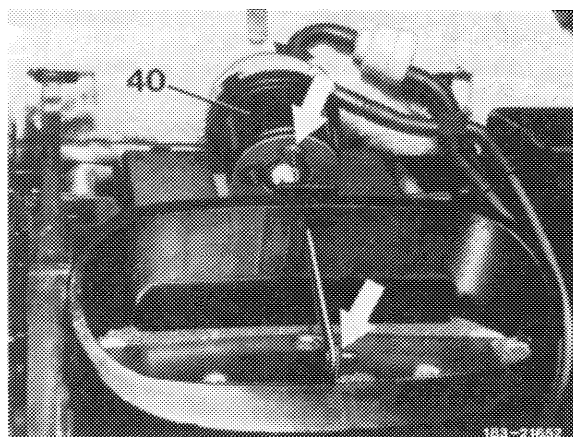

Layout of electric switchover valves

- 13 Center nozzle flap
- 14 Legroom flap
- 15 Defroster nozzle flap
- 17 Main air flap
- 18 Fresh air-recirculating air flap

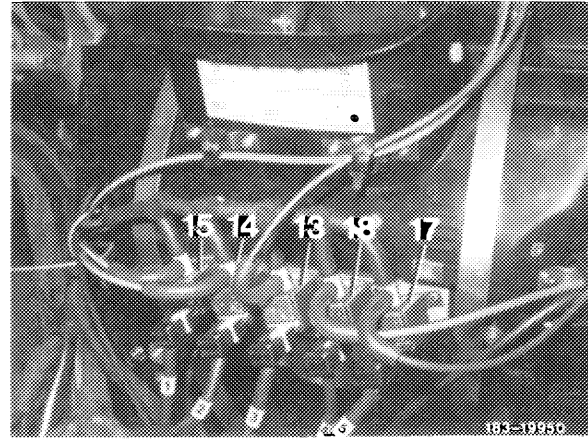

The vacuum elements (38 to 42) for air flaps in air conditioning cabinet are activated with vacuum by means of the electric switchover valves (13 to 18).

All switchover valves (13 to 18) are generally set to passage when energized and will activate all vacuum elements directly.

- 38 2-stage vacuum element for defroster nozzle flaps
- 39 Vacuum element for legroom flaps
- 44 Throttle (orifice)

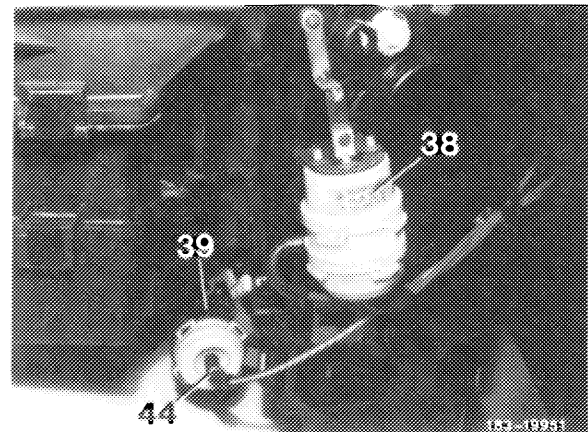

- 40 Vacuum element for center nozzle flap
- 44 Throttle (orifice)
- 45 Check valve
- 49 4-point distributor
- 50 3-point distributor

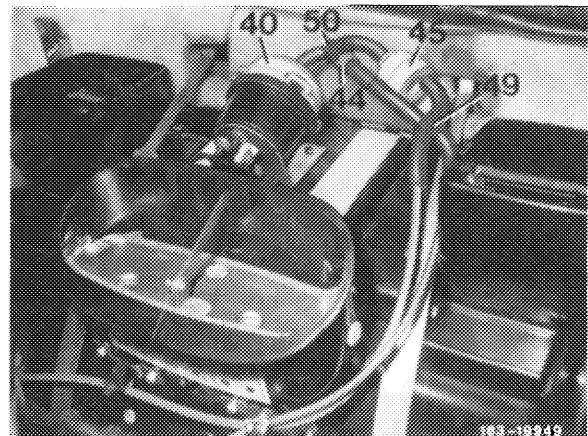

- 9 Electronic switching unit for temperature control
- 29 ETR-switch
- 42 Vacuum element for main air flap

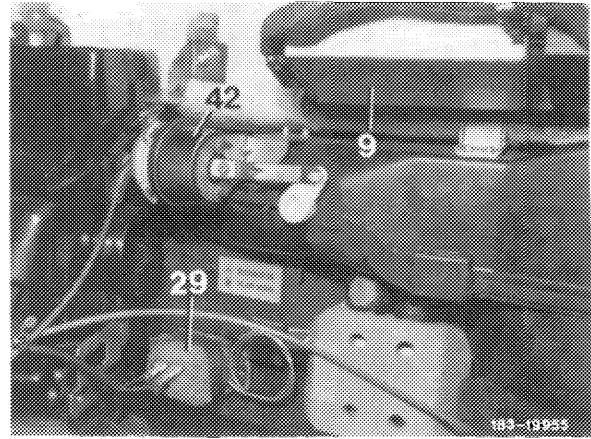

- 12 Blower motor
- 41 Vacuum element for fresh air – recirculating air flap
- 47 Air jet

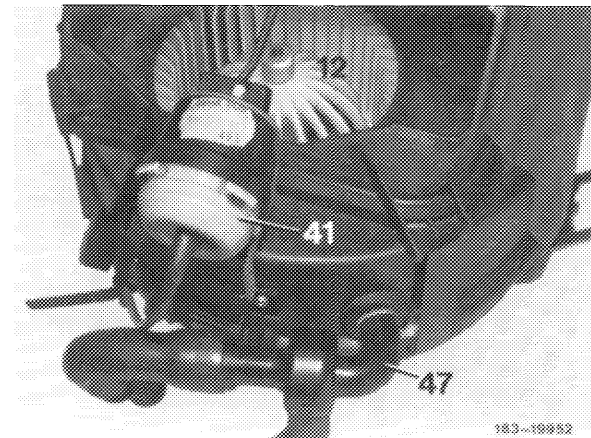

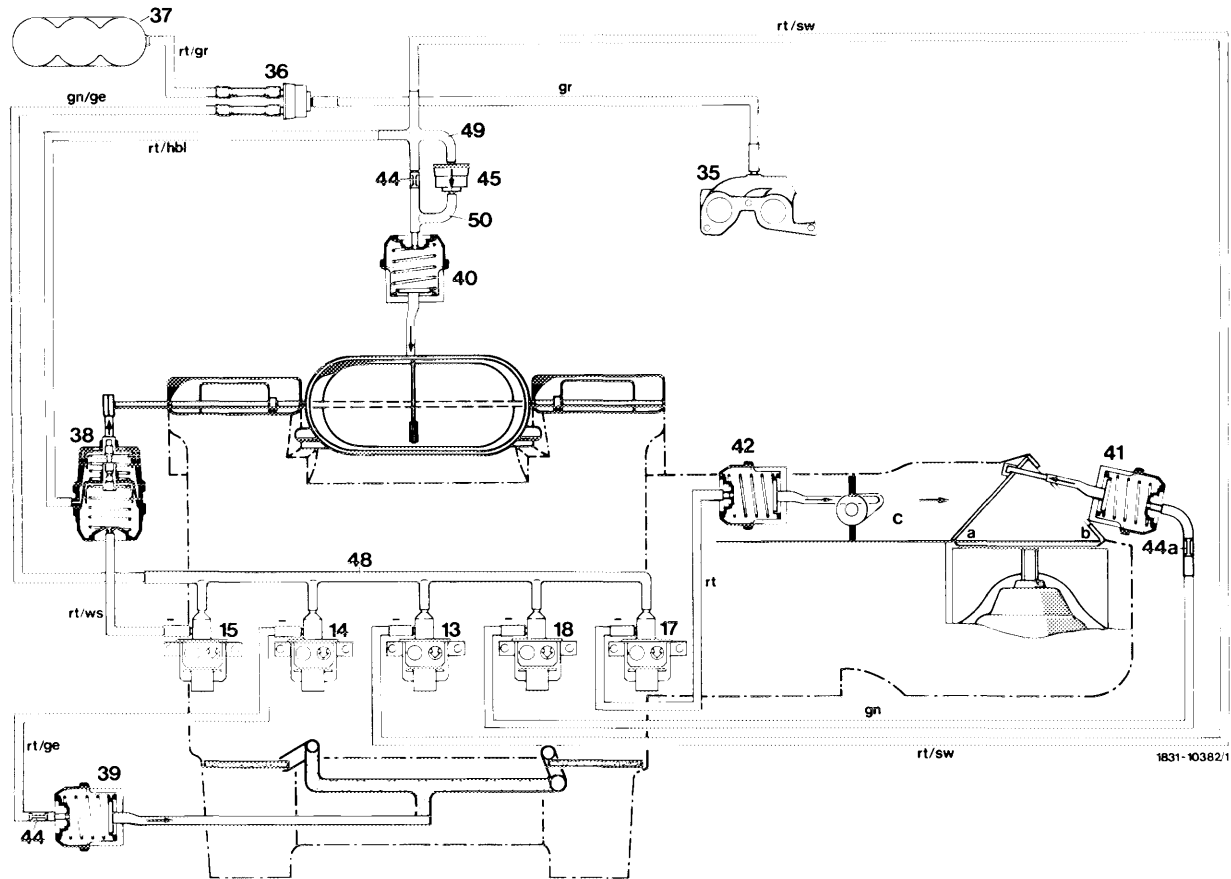

Vacuum function diagram automatic climate control

- 13 Switchover valve for center nozzle flap
- 14 Switchover valve for legroom flaps
- 15 Switchover valve for defroster nozzle flaps
- 17 Switchover valve for main air flap
- 18 Switchover valve for fresh air-recirculating air flap
- 35 Vacuum connection at intake manifold
- 36 Check valve
- 37 Vacuum reservoir
- 38 2-stage vacuum element for defroster nozzle flaps (flaps "open")
- 39 Vacuum element for legroom flaps (flaps "closed")
- 40 Vacuum element for center nozzle flap (flap "closed")
- 41 Vacuum element for fresh air-recirculating air (flap "closed", position "recirculating air")
- 42 Vacuum element for main air flap (flap "closed")
- 44 Throttle (orifice)
- 44a Throttle (orifice) starting 05/82
- 45 Check valve (arrow = direction of passage)
- 48 6-point distributor
- 49 4-point distributor
- 50 3-point distributor
- a Position "recirculating air"
- b Position "fresh air"
- c Position "fresh air"

Color code of vacuum lines
 ge = yellow
 gn = green
 gr = gray
 rt = red
 ws = white
 hbl = light blue
 sw = black