

83–665 Removal and installation of vacuum elements

Data

Permissible leaking of vacuum elements	20 mbar/min at 300 mbar vacuum
Plug-on length of connections	10–12 mm

Special tool

Tester for vacuum systems	116 589 25 21 00
---------------------------	------------------

A. Vacuum element for center jet

Removal

1 Remove instrument panel (68–100).

2 Pull vacuum line from vacuum element (40).

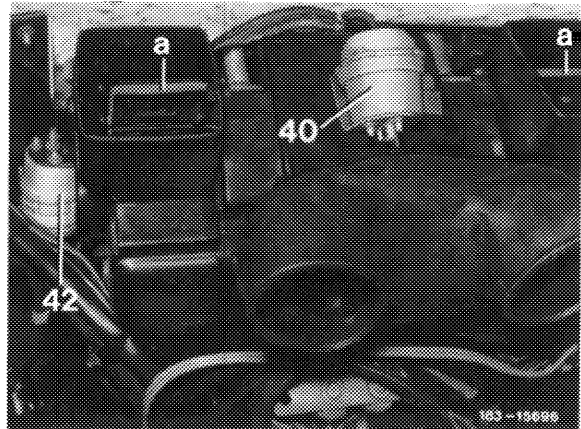

3 For removal of vacuum element (40) for center jet, remove clamp (63) and lift off lock (64) with a screwdriver.

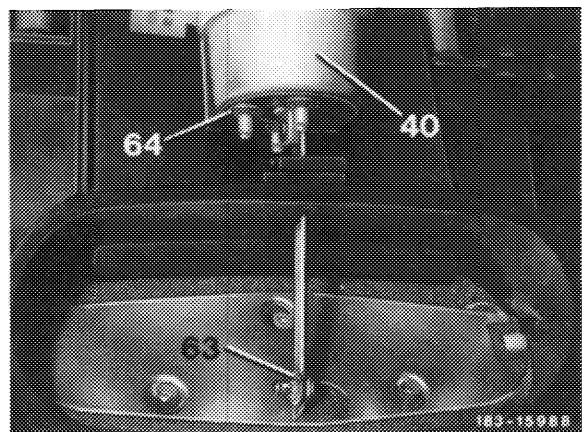

Installation

4 Attach vacuum element (40) to holder or air conditioner cabinet with locks (64) and rubber discs.

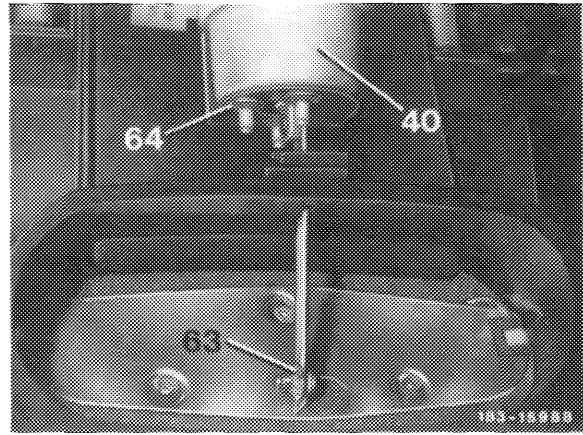

5 Plug on vacuum line and mount actuating rod with clamp (63). Check vacuum element (40) for operation and leaks.

6 Install instrument panel (68–100).

B. Vacuum element (42) for defroster jets

Removal

1 Remove cover at left under instrument panel.

2 Pull vacuum line or on version 2 two vacuum lines from vacuum element (42).

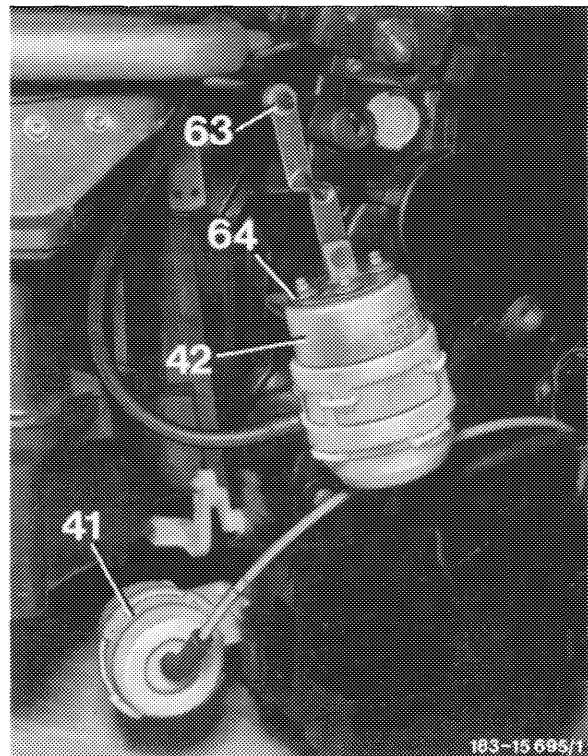

Layout 2-stage vacuum element (43) for defroster jets (version 2)

3 For removing 1-stage vacuum element (42) for defroster jet, remove clamp (63) and lift off locks (64) with a screwdriver (version 1).

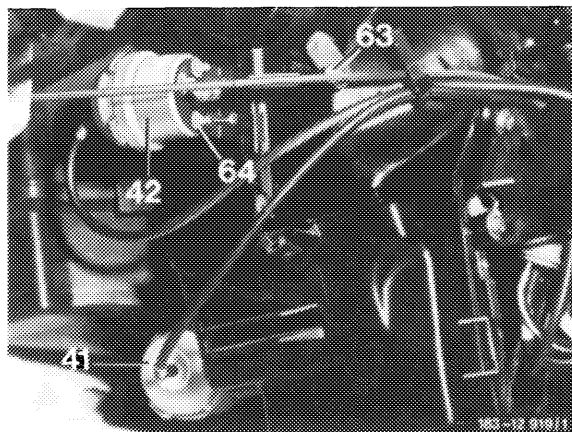

Version 1

4 On 2-stage vacuum element (42) for defroster jet, lift off locks (64) with a screwdriver (version 2 starting August 78).

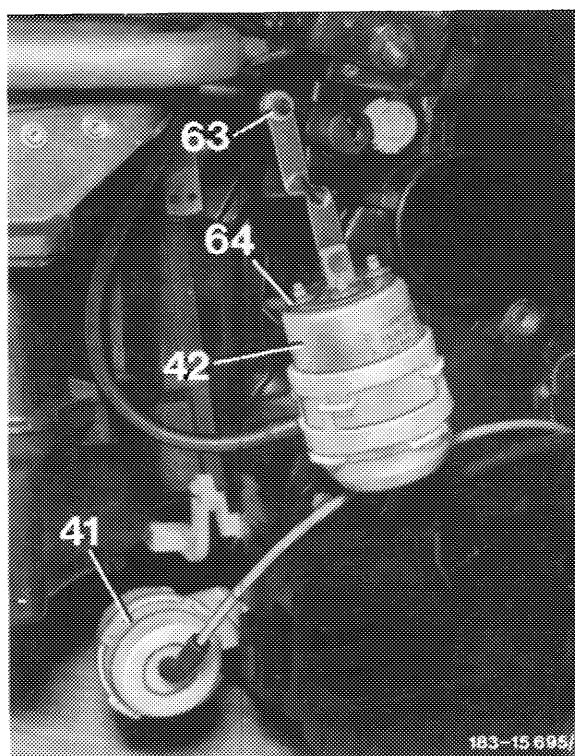

Version 2

5 If the housing top (65) or the sleeve (67) are damaged, remove these parts from new vacuum element and install (for 1-stage vacuum element, version 1 only).

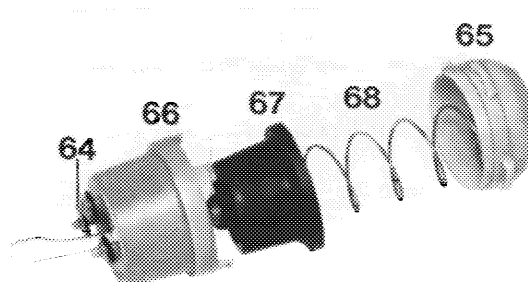

- | | |
|---------------------------|-------------------|
| 64 Lock and rubber washer | 66 Housing bottom |
| 65 Housing top | 67 Sleeve |
| | 68 Spring |

183-11083

Attention!

Always renew 2-stage vacuum element (42) in the event of operational trouble or leaks.

Installation

6 Attach vacuum element (42) to holder of air conditioner housing by means of locks (64) and rubber washers.

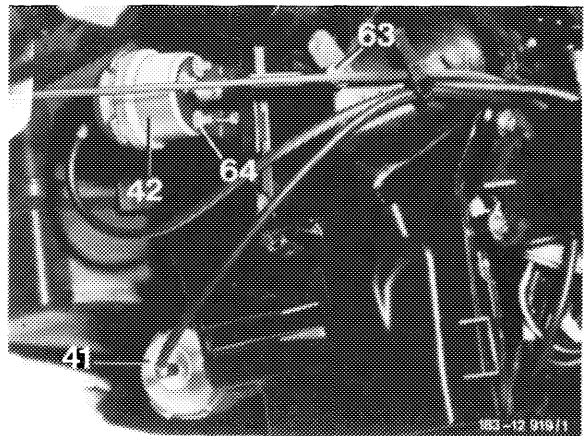

7 Plug on vacuum line and mount actuating rod with clamp (63). Check vacuum element (42) for operation and leaks.

C. Vacuum element (41) for legroom flaps**Removal**

- 1 Remove cover at left under instrument panel.
- 2 Pull off vacuum line on vacuum element (41).
- 3 Remove clamp (63) from connecting rod.

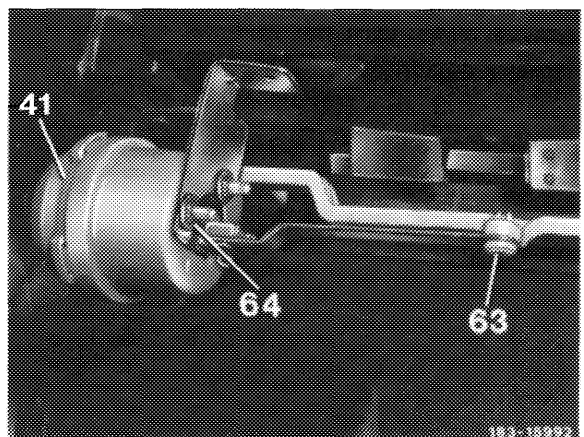

4 Carefully remove housing top (65) from housing bottom (66), remove spring (68) and sleeve (67).

5 If the housing top (65) or the sleeve (67) are damaged, remove these parts from new vacuum element and install.

6 If housing bottom (66) is damaged, remove locks (64).

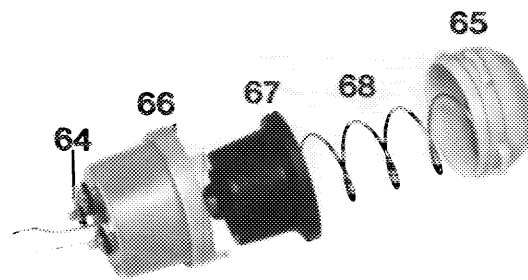

64 Lock and rubber washer	66 Housing bottom
65 Housing top	67 Sleeve
	68 Spring

83-11983

Installation

7 When installing a new vacuum element, always use new locks (64) with rubber washers.

8 Mount vacuum line on vacuum element (41), check operation and for leaks.

9 Install cover at left under instrument panel.

D. Vacuum element (43) for main air flap

Removal

1 Remove glove box (68-140).

2 Remove air hose from heater box to lateral vent at the right.

3 Pull off vacuum line (arrow) on vacuum element (43).

4 For removing vacuum element (43) for main air flap, take off clamp (63) and lift off fuses (64) by means of a screwdriver.

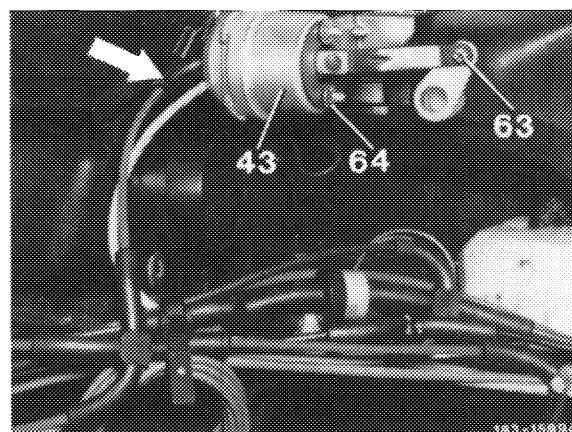

Installation

- 5 Attach vacuum element (43) to holder together with locks (64) and rubber washers.
- 6 Mount vacuum line (arrow) and install connecting rod with clamp (63).

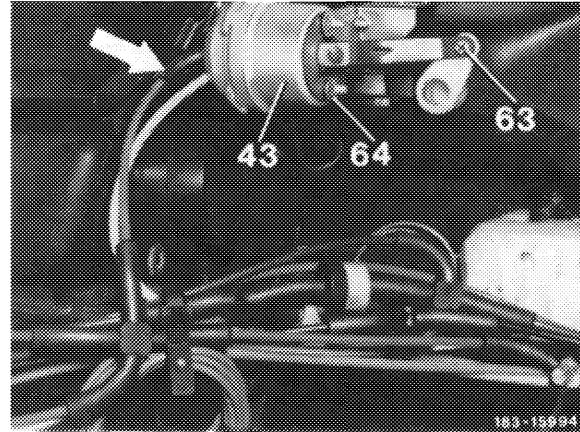

- 7 Check vacuum element (43) for operation and leaks.
- 8 Install air hose from heater box to lateral vent at the right.
- 9 Install glove box (68–140).

E. Vacuum element (44) for fresh air-recirculated air flap

Removal

- 1 Remove glove box (68–140).
- 2 Remove blower motor (83–120).
- 3 Pull off vacuum line (arrow) on vacuum element (44).
- 4 Remove clamp from connecting rod on fresh air-recirculated air flap from below.
- 5 Lift off locks (64) by means of a screwdriver.

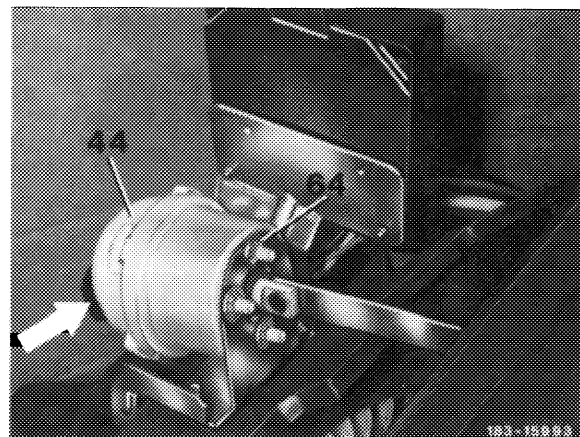

Installation

- 6 Attach vacuum element (44) to holder by means of locks (64) and rubber washers.
- 7 Mount vacuum line (arrow) and attach connecting rod to fresh air-recirculated air flap by means of fastening clamp.
- 8 Check vacuum element (44) for operation and leaks.
- 9 Install blower motor (83–120).
- 10 Install glove box (68–140).