

## INTRODUCTION

This manual contains schematic diagrams, component location descriptions, and photographs for the cars shown in Table 1 below. The manual consists of six sections: one section for each of the 5 car groups and one section that contains Automatic Climate Control data for all cars.

The first page of each section is an index page. Circuits are listed alphabetically with page numbers for schematics and component location descriptions. Schematic diagrams should be referred to when diagnosing a problem (see Troubleshooting Procedure, page 5). The component location descriptions and photographs are used to locate components on the vehicle.

Automatic Climate Control data, for all cars for which it's applicable, is contained in the last section of the book. Refer to the ACC index on page 301 for the listing of ACC data by car sales designations.

MODEL	SALES DESIGNATION
107.045	380 SL
107.048	560 SL
123.123	240 D
123.133	300 D (Turbo)
123.153	300 CD (Turbo)
123.193	300 TD (Turbo)
126.032	380 SE
126.033	380 SEL
126.043	380 SEC
126.037	500 SEL
126.044	500 SEC
126.035	420 SEL
126.039	560 SEL
126.045	560 SEC
126.120	300 SD (Turbo)
126.125	300 SDL (Turbo)

Table 1

## HOW TO USE THIS MANUAL

### How to Read Schematic Diagrams

Electrical components which work together are shown together. Schematic drawings are arranged so that current flows from positive at the top of the page, to negative at the bottom. Fuses are shown at the top of the page. All wires, connectors, switches, and motors are shown in the flow of current to ground at the bottom of the page. The "hot" labels appearing at the top of fuses or components show the IGNITION SWITCH positions which supply power to the point.

The terminal number "30" appearing on the IGNITION SWITCH and LIGHT SWITCH, means that these terminals are always supplied with power. The terminal number "15" on the IGNITION SWITCH means that this terminal is supplied with power only when the IGNITION SWITCH is in the "Run" or "Start" positions.

### Component and Wire Representation

All wiring between components is shown exactly as it exists on the vehicle. Wiring inside complicated components has been simplified to aid in understanding their electrical operation. Transistorized components are shown as plain boxes labeled "solid state." Switches and sensors are shown "at rest," as if the IGNITION SWITCH were off. Notes are included which describe how switches and other components work.

### Circuits Which Share Power and/or Grounds

Each circuit is shown completely on one schematic diagram. Wires common to different schematics are cross referenced and marked with arrows. To find other circuits which might share fuse terminals or screw terminal blocks, look in the Power Distribution schematics. To find other circuits which might share connections to ground terminals, look in the Ground Distribution schematics.

### Power Distribution and Ground Distribution Diagrams

The Power Distribution diagrams show connections from the BATTERY and ALTERNATOR to the fuses, and to the IGNITION SWITCH and LIGHT SWITCH. This will tell you how each circuit gets its power, and what circuits share common fuses. Ground Distribution diagrams show how several circuits are connected to common grounds.

### Component Identification

Component names are found underlined next to or above each component. The name is followed, in many cases, by some detail about the component or its operation. Below the component name, in parentheses, you may find a "code" number. This is the factory harness marking number. It is printed on tape wrapped around the branch of the wiring harness which feeds that component.

Some Automatic Climate Control components have a number with an asterisk above the component name. This is the ACC training number for that component.

# SYMBOLS

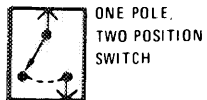

ONE POLE, TWO POSITION SWITCH



SWITCHES THAT MOVE TOGETHER

DASHED LINE SHOWS A MECHANICAL CONNECTION BETWEEN SWITCHES

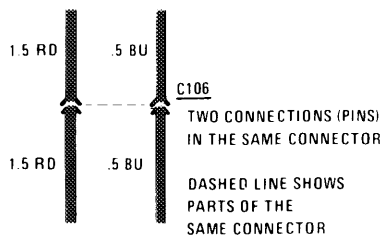

TWO CONNECTIONS (PINS) IN THE SAME CONNECTOR

DASHED LINE SHOWS PARTS OF THE SAME CONNECTOR



RELAY SHOWN WITH NO CURRENT FLOWING THROUGH COIL

WHEN COIL IS ENERGIZED, SWITCH IS PULLED CLOSED



DIODE CURRENT CAN FLOW ONLY IN THE DIRECTION OF THE ARROW

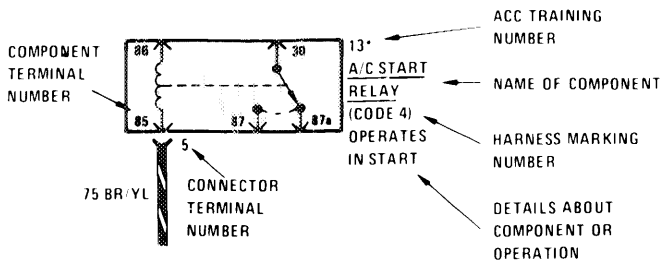

ACC TRAINING NUMBER  
NAME OF COMPONENT  
HARNESS MARKING NUMBER  
OPERATES IN START  
DETAILS ABOUT COMPONENT OR OPERATION

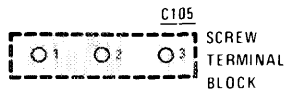

SCREW TERMINAL BLOCK

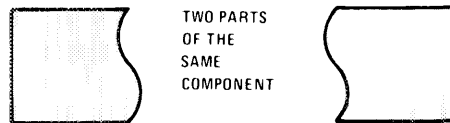

TWO PARTS OF THE SAME COMPONENT

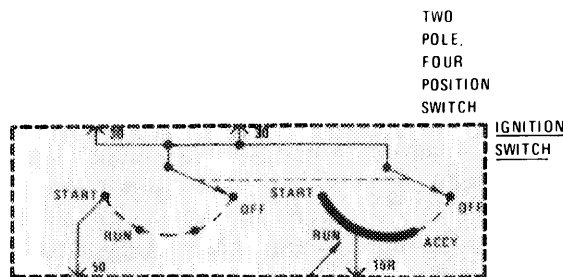

TWO POLE, FOUR POSITION SWITCH

IGNITION SWITCH

"15R" IS ENERGIZED IN ACCY, RUN OR START

WIRE INSULATION	
COLOR	ABBREVIATIONS
BLACK	BK
BROWN	BR
RED	RD
YELLOW	YL
GREEN	GN
BLUE	BU
VIOLET	VI
GRAY	GY
WHITE	WT
PINK	PK

WIRE SIZE CONVERSION CHART	
METRIC (CROSSSECTIONAL AREA IN MM <sup>2</sup> )	AWG (AMERICAN WIRE GAUGE)
5	20
7.5	18
1	16
1.5	14
2	13
2.5	12
3	10
3	8
3	8
4	4
28	4
25	2
32	2

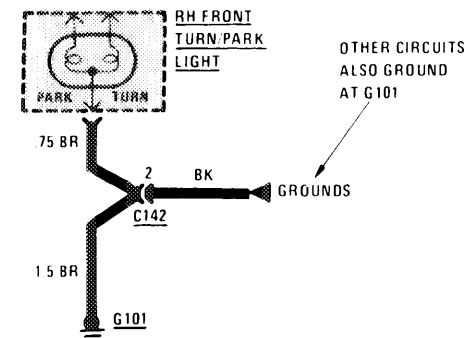

OTHER CIRCUITS ALSO GROUND AT G101

REVISIONS:

ALL MODELS

# SYMBOLS

4:86

ALL MODELS



ENTIRE COMPONENT SHOWN



PART OF A COMPONENT SHOWN

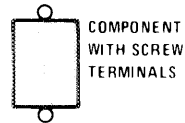

COMPONENT WITH SCREW TERMINALS



TRANSISTORIZED COMPONENT

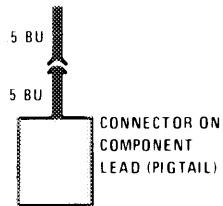

CONNECTOR ON COMPONENT LEAD (PIGTAIL)

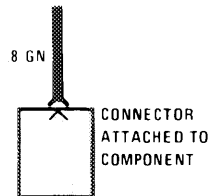

CONNECTOR ATTACHED TO COMPONENT

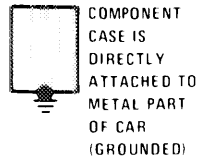

COMPONENT CASE IS DIRECTLY ATTACHED TO METAL PART OF CAR (GROUNDED)

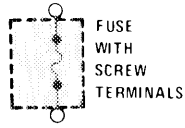

FUSE WITH SCREW TERMINALS

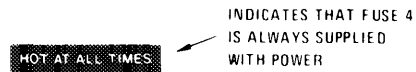

INDICATES THAT FUSE 4 IS ALWAYS SUPPLIED WITH POWER

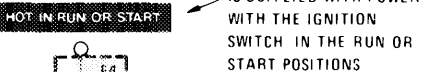

INDICATES THAT FUSE 4 IS SUPPLIED WITH POWER WITH THE IGNITION SWITCH IN THE RUN OR START POSITIONS

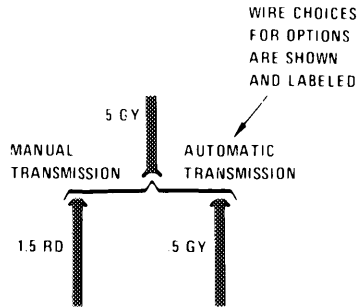

WIRE CHOICES FOR OPTIONS ARE SHOWN AND LABELED

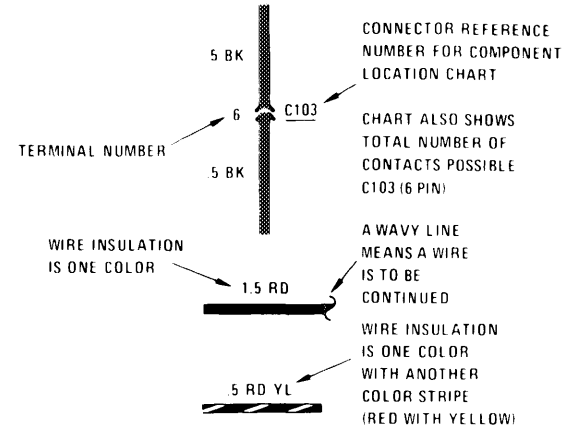

CONNECTOR REFERENCE NUMBER FOR COMPONENT LOCATION CHART

CHART ALSO SHOWS TOTAL NUMBER OF CONTACTS POSSIBLE C103 (6 PIN)

A WAVY LINE MEANS A WIRE IS TO BE CONTINUED

WIRE INSULATION IS ONE COLOR WITH ANOTHER COLOR STRIPE (RED WITH YELLOW)

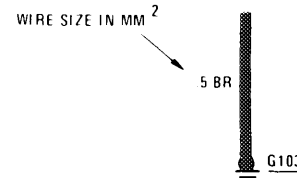

WIRE SIZE IN MM<sup>2</sup>

WIRE IS ATTACHED TO METAL PART OF CAR (GROUNDED)

GROUND IS NUMBERED FOR REFERENCE ON COMPONENT LOCATION CHART OTHER CIRCUITS THAT SHARE A GROUND ARE SHOWN IN GROUND DISTRIBUTION

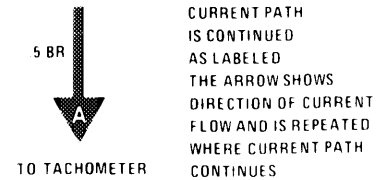

CURRENT PATH IS CONTINUED AS LABELED THE ARROW SHOWS DIRECTION OF CURRENT FLOW AND IS REPEATED WHERE CURRENT PATH CONTINUES

A WIRE WHICH CONNECTS TO ANOTHER CIRCUIT



LIGHTS TURN HAZARD STOP

3

REVISIONS:

# SYMBOLS

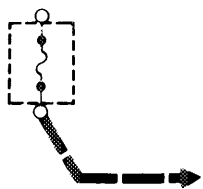

THIS FUSE FEEDS OTHER CIRCUITS WHICH ARE NOT SHOWN HERE. THESE CIRCUITS ARE IDENTIFIED IN "POWER DISTRIBUTION."



CIRCUITS NOT SHOWN HERE SHARE THIS GROUND. THESE CIRCUITS ARE IDENTIFIED IN GROUND DISTRIBUTION



VACUUM RESTRICTORS ARE POROUS BRASS PLUGS IN THE VACUUM HOSE. THE RESTRICTOR SLOWS THE VACUUM FLOW



VACUUM CAN FLOW EASILY IN THE DIRECTION OF THE ARROW. VACUUM CANNOT FLOW AGAINST THE ARROW

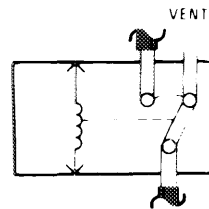

A SWITCHOVER VALVE IS A SOLENOID OPERATED VACUUM VALVE. THE VALVE IS VENTED WHEN THE COIL OF THE SOLENOID IS DE-ENERGIZED

NO VACUUM

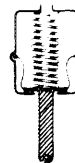

VACUUM ELEMENTS PUSH OR PULL A SHAFT BETWEEN TWO FIXED POSITIONS. WHEN VACUUM IS APPLIED, THE SHAFT IS PULLED IN. WHEN NO VACUUM IS PRESENT, THE SHAFT IS PUSHED OUT BY A SPRING



INDUCTIVE SENSOR



TEMPERATURE SENSOR

ALL MODELS

REVISIONS:

## TROUBLESHOOTING

### TROUBLESHOOTING PROCEDURE

#### 1. VERIFY THE COMPLAINT

Operate the problem circuit in all modes to check the accuracy of the complaint. This may give a clue as to the extent, nature, and location of the problem.

#### 2. CHECK THE FUSE AND RELATED CIRCUITS

Determine the extent of the problem by operating circuits which share the same fuse. If the other circuits work, the fuse is good. The cause must be within the wiring unique to the problem circuit.

#### 3. REFER TO THE E.T.M. AND ANALYZE THE CIRCUIT

Study the circuit schematic to learn how the circuit should operate. The schematic will tell you:

- Where the circuit receives current.
- What circuit protection is involved.
- What switches control current flow.
- How the loads operate.

Understanding the total circuit is necessary if you are to troubleshoot efficiently. Determine possible problem areas and testing locations. The Component Location table tells where components and ground points are located.

#### 4. SYSTEMATICALLY TEST THE CIRCUIT IN ORDER TO ISOLATE THE PROBLEM

As a general guideline:

- If the fault affects a single component of a circuit, start to test at that component.
- If the fault affect a number of components of a circuit, start to test at the point where the circuit gets its power.

#### 5. MAKE THE REPAIR

After you have narrowed the problem down to a specific cause, repair as necessary.

#### 6. VERIFY CIRCUIT OPERATION

First operate the repaired circuit in all modes to be sure you have fixed the entire problem. Next, operate all circuits which share the same fuse. Be sure that this does not cause the problem to reappear.

### TESTING TOOLS

A **VOLTMETER** is used to measure voltage at various points within a circuit. If an analog **VOLTMETER** is used, it must have a resistance of at least 20,000 ohms per volt in the low range. Any digital **VOLTMETER** may be used.

Use of an **OHMMETER** should be limited to harness wiring, connections, and switches. It should not be used on solid state components or relays. An **OHMMETER** measures a circuit for its resistance to current flow. Since an **OHMMETER** has an internal battery that provides current to the circuit under test, it is first necessary to disconnect the car battery. This will ensure that there is no voltage already present in the circuit.

An **AMMETER** measures the current flowing within a circuit. There are two types of **AMMETERS**: the **SERIES AMMETER** and the **INDUCTIVE** (clamp-on) **AMMETER** (e.g. Sun DMM-5). The **INDUCTIVE AMMETER** is clamped around a wire in the circuit under test. The **SERIES AMMETER** must be connected into the circuit.

A **SERIES AMMETER** must never be connected in parallel with a component. This can cause a short circuit and damage the meter.

An **ACC Adaptor Switch** is used to test circuits in the new Automatic Climate Control system. To use this tester, first unplug the connector from the **ELECTRONIC UNIT FOR TEMPERATURE CONTROL**. Then plug this connector to the **Adaptor Switch** (M-B part no. 126 589 03 21 00). A voltmeter-ohmmeter is then connected to the **Adaptor Switch**.

# TROUBLESHOOTING

## TESTS

### Voltage Test

1. Connect the negative lead of the VOLT-METER to a known good ground or negative (-) battery terminal.
2. Connect the positive lead of the VOLT-METER to a point (connector or terminal) you wish to test.
3. If the meter registers, there is voltage present. This voltage should be within one volt of measured battery voltage. A loss of more than one volt indicates a problem. A loose connection is a likely cause. Take readings at several points along the circuit to isolate the problem.

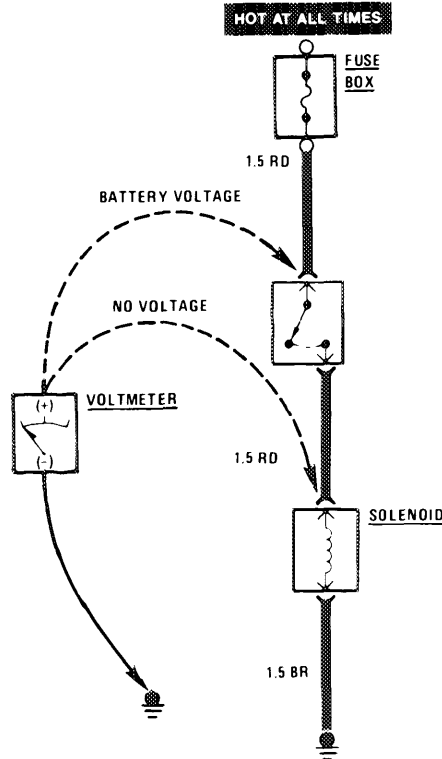

Voltage Test

### Voltage Drop Test

This test checks for voltage being lost along a wire, or through a connection or switch.

1. Connect the positive lead of the VOLT-METER to the end of the wire, or to the side of the connection which is closest to the battery.
2. Connect the negative lead to the other end of the wire, or the other side of the connection.
3. When the circuit is operated, the VOLT-METER will show the difference in voltage between the two points. A difference (or drop) of more than one volt indicates a problem.

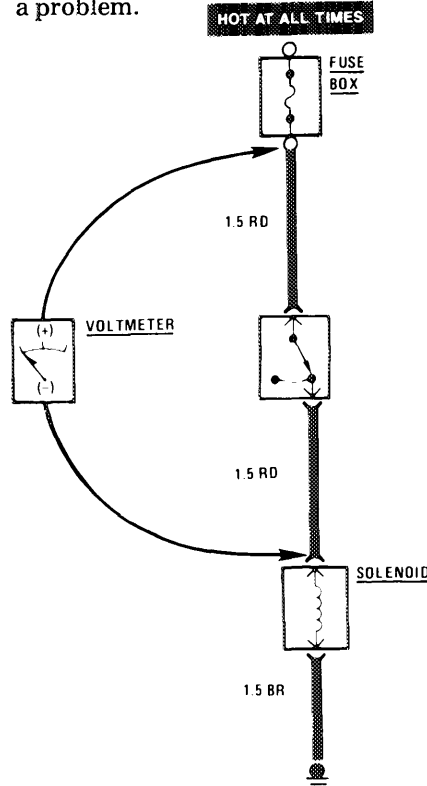

Voltage Drop Test

### Testing For Short to Ground With a Voltmeter

1. Remove the blown fuse and disconnect the load.
2. Connect the VOLTMETER across the fuse terminals.
3. Beginning near the fuse box, move the harness from side to side while watching the VOLTMETER.
4. If the meter registers, there is a short to ground in the wiring.

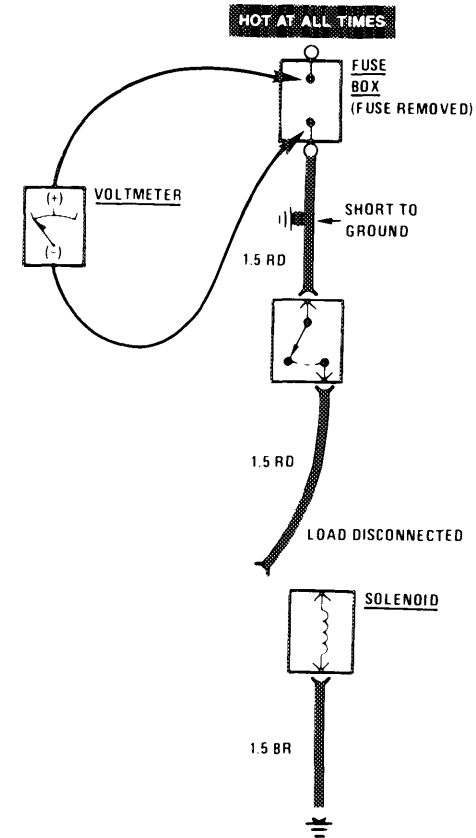

Testing for Short with Voltmeter

REVISIONS:

## TROUBLESHOOTING

### Continuity Test

1. Check OHMMETER by adjusting the needle to zero while holding the leads together.
2. Disconnect the car battery.
3. Connect one lead of the OHMMETER to one end of the part of the circuit you wish to test.
4. Connect the other lead to the other end.
5. If the meter shows low or no resistance, there is continuity.

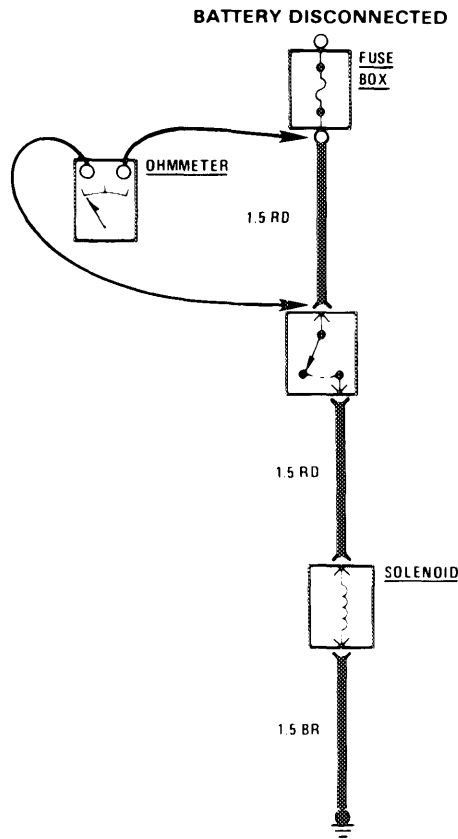

Continuity Test

### Testing For Short to Ground With an Ohmmeter

1. Calibrate OHMMETER by adjusting the needle to zero while holding the leads together.
2. Remove the blown fuse and disconnect the battery and load.
3. Connect one lead of the OHMMETER to the fuse terminal on the load side.
4. Connect the other lead to a known good ground.
5. Beginning near the fuse box, move the harness from side to side, while watching the OHMMETER.
6. If there is no short, the meter will show infinitely high resistance. If the meter registers low or no resistance, there is a short to grounding the wiring.

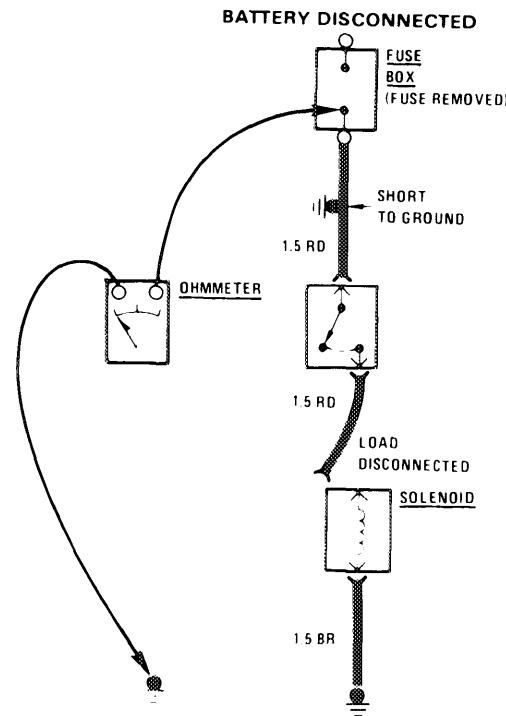

Testing for Short with Ohmmeter

### Current Test With a Series Ammeter

1. Disconnect the circuit at a convenient point such as a connector.
2. Connect a lead of the AMMETER to one side of the open circuit.
3. Connect the second lead of the AMMETER to the other side of the open circuit. The AMMETER completes the circuit.
4. With the circuit operating, the AMMETER will show how much current is flowing in the circuit.

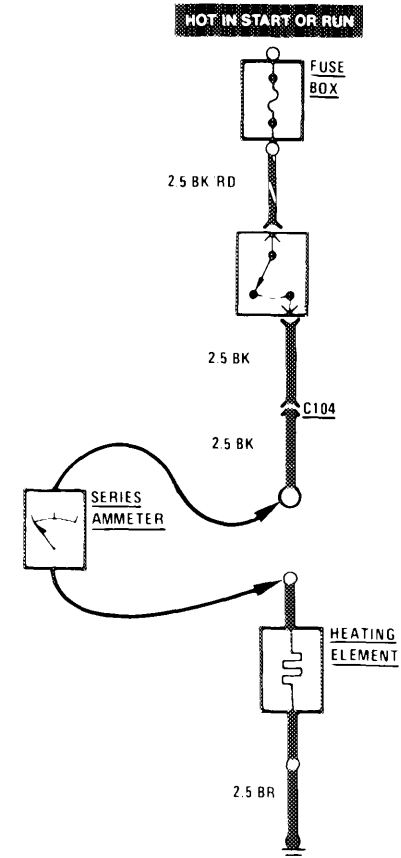

Current Test (Series Ammeter)

REVISIONS:

## Current Test With an Inductive Ammeter

1. Clamp the AMMETER pliers around the wire under test in the circuit.
2. With the circuit operating, the AMMETER will show how much current is flowing in the circuit.

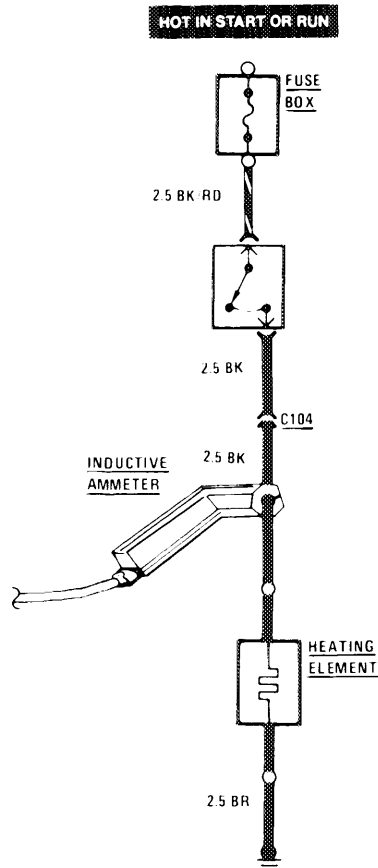

Current Test (Inductive Ammeter)

## Troubleshooting Vacuum Components

A VACUUM TESTER is used to apply vacuum to vacuum components. The tester (M-B part no. 589 25 2100) registers in mbar of vacuum. Two typical applications of this tester are shown below.

PERMISSIBLE LEAKS	
Check Valves	50 mbar in 10 min. at 300 mbar vacuum
Other Vacuum Components	20 mbar/min. at 300 mbar vacuum

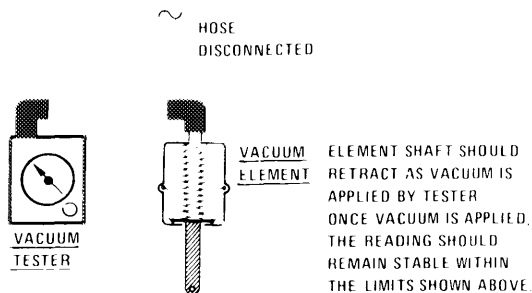
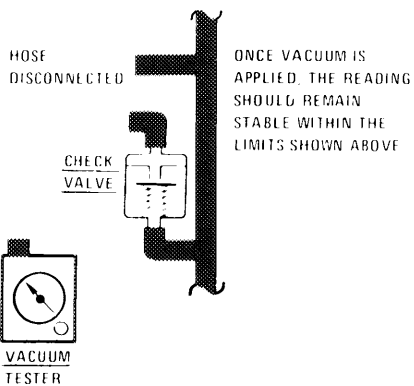

## Switchover Valves (as of MY 1984)

The former switchover valves on all models are replaced by a standard switchover valve.

When de-energized (no current), the side and the lower pipes are connected to each other. When energized, the upper pipe connects to the side pipe. If only two pipes are used, a standard protective cap with vent is plugged onto the third pipe.

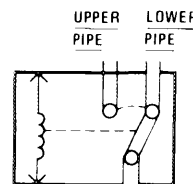

SCHEMATIC SYMBOL FOR SWITCHOVER VALVE

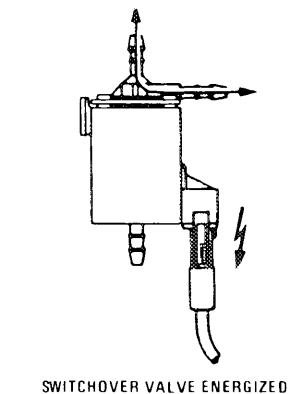
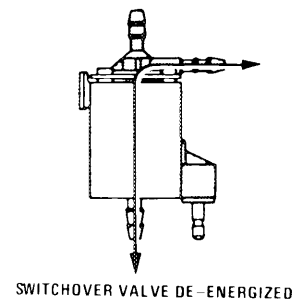

REVISIONS:



## CIRCUIT IDENTIFICATION

Circuit	Description		
1	Negative side of ignition coil (low voltage).	85	Relay winding; ground side.
4	Output of ignition coil (high voltage).	86	Relay winding, positive side.
15	Battery voltage; ignition switch in RUN (pos. 2) or START.	87	Relay output; normally open.
15R	Battery voltage; ignition switch in ACCESSORY (pos. 1), RUN (pos. 2) or START.	87a	Relay output; normally closed.
15X	Battery voltage; ignition switch in RUN (pos. 2).	K, K30	Battery voltage; light switch in parking or headlight position.
16	Ignition switching unit connection from negative side of coil.	L	Turn signal lights; left side.
30	Battery voltage; "hot" at all times.	LA	Pre-glow indicator.
31	Ground.	N	Fog light switch; output.
31b	Switched ground.	NSE	Fog lamp switch; input.
49	Turn signal/hazard flasher input.		Models 107, 123, 126: battery voltage with light switch in HEADLIGHT position and combination switch in LOW BEAM position.
49a	Turn signal/hazard flasher output.	P30	Power feed for R & L standing lights; battery voltage with ignition switch in OFF or ACCESSORY position.
50	Starter motor control.	R	Turn signal lights; right side.
56	Power feed for headlights.	TD	Engine speed signal.
56a	Headlights; high beam and indicator light.		<b>NOTE:</b> Circuit Identification numbers will appear on schematics inside component boxes. Connector terminal numbers will appear on schematics outside component boxes.
56b	Headlights; low beam.		
56d	Headlight; flasher.		
58d	Instrument lighting output; variable.		
58L	Parking, tail, side marker lights; left side.		
58R	Parking, tail, side marker lights; right side.		
58N	Fog lights.		
61	Charge indicator.		

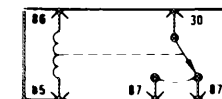

REVISIONS: