

05–220 Removal and installation of camshaft

Timing with 2 mm valve lift

Engine	Camshaft code ¹⁾	Intake valve opens after TDC	closes after BDC	Exhaust valve opens before BDC	closes before TDC
615.912/913 615.940 (40 kW) 615.941 616.916 616.912 (48 kW)	02 06 ²⁾	with new timing chain			
		11.5°	13.5°	21°	19°
		with used timing chain (from about 20,000 km)			
		13.5°	15.5°	19°	17°
615.940 (44 kW) 616.912 (53 kW)	10 ²⁾	with new timing chain			
		9°	15°	27°	16°
		with used timing chain (from about 20,000 km)			
		11°	17°	25°	14°
617.910 617.912 (59 kW)	00 08 ²⁾	with new timing chain			
		11.5°	13.5°	21°	19°
		with used timing chain (from about 20,000 km)			
		13.5°	15.5°	19°	17°
		with new timing chain			
		with used timing chain (from about 20,000 km)			

¹⁾ The camshaft code is stamped in the aft camshaft end.

²⁾ Camshaft made of chilled casting.

Valve clearance	engine cold (approx. 20 °C)	engine hot (60 °C ± 15 °C)
Intake	0.10 ¹⁾	0.15 ¹⁾
Exhaust	0.30	0.35

¹⁾ 0.05 mm greater for steady ambient temperatures below –20 °C.





Data

Permissible eccentricity of center journals and of camshaft sprocket seat, with camshaft mounted in outer bearings	Camshaft code	02	06.10	00	08
	Camshaft sprocket seat	0.012	0.025	0.020	0.020
	2nd bearing	0.012	0.025	0.030	0.030
	3rd bearing	—	—	0.025	0.025
Scleroscope hardness of cams		70–82	64–75	70–82	64–75

Tightening torques

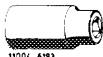
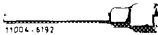
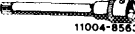
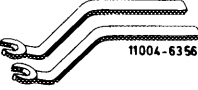
		Nm	(kpm)
Bolts for cylinder head cover (engine 615)		5	(0.5)
Nuts for cylinder head cover (engines 615, 616, 617.91)		15	(1.5)
Camshaft bearing bolts (hexagon socket cylinder head bolts)		100	(10)
Camshaft bearing bolts (twelve-point socket cylinder head bolts)	1st step	40	(4)
	2nd step	70	(7)
	3rd step		90°
	4th step		90°
Nuts M 8 for camshaft bearings		25	(2.5)
Waisted bolt for camshaft sprocket		80	(8)
Rocker arm brackets to cylinder head		40	(4)

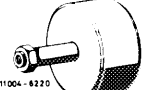
Special tools

Socket 27 mm, 1/2" drive to crank engine		001 589 65 09 00
Screwdriver socket 10 mm, 1/2" drive, 140 mm long for hexagon socket cylinder head bolts		000 589 05 07 00
Screwdriver socket 1/2" drive, 140 mm long for twelve-point socket cylinder head bolts		617 589 00 10 00
Valve adjusting wrench 14 mm (two)		615 589 00 01 00
Holding wrench for valve spring cap		615 589 00 03 00
Impact extractor for bearing pin (basic unit)		116 589 20 33 00
Threaded stud for impact extractor M 6, 50 mm long		116 589 01 34 00

Dial gauge holder

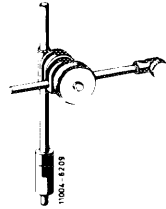

121 589 00 21 00

Remote starter switch
for cranking engine
(individual component of compression
pressure recorder 001 589 46 21 00)

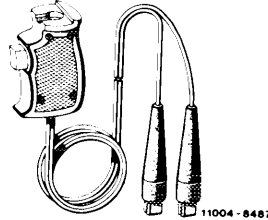

001 589 46 21 08

Commercially available tool

Dial gauge A 1 DIN 878

e.g. Mahr, 7300 Esslingen
order No. 810

Note

If a new camshaft is required, always replace rocker arms, too.

If rocker arms have hard backing, only replace damaged ones.

The larger cylinder charge needed for uprated engines has been obtained by increasing the valve lift.

The intake and exhaust cams on the camshaft have been modified in height (H) and shape for this purpose.

Valve lift, uprated engines

Intake	10.0 mm
Exhaust	10.4 mm

Valve lift, normal power engines

Intake and exhaust 8.5 mm

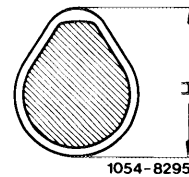

These measures impose heavier loads on the camshafts and therefore it has become necessary to select a different pair of materials for camshaft and rocker arm.

The camshaft of the uprated engine (code No. 10) is a chilled casting and the corresponding rocker arms have a hard-backed, soldered contact surface (B, arrow).

- A Rocker arm, induction hardened and hard chrome plated
- B Rocker arm with hard backing

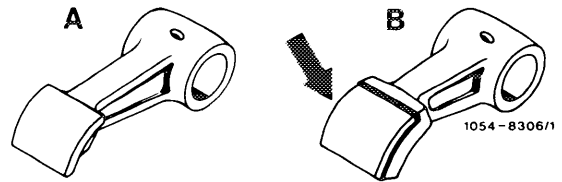

On account of the larger valve lift (higher cams), camshaft bearings No. 2 and No. 3 have had to be increased by 2.5 mm in diameter (D), to allow the camshaft to be fitted. Accordingly, camshaft journals No. 2 and No. 3 are 2.5 mm larger in diameter.

- Camshaft bearings No. 2 and No. 3
- Normal power engines D = 46.5 mm
- Uprated engines D = 49.0 mm

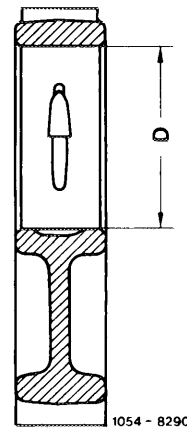

Besides, camshaft bearings No. 2 and No. 3 have additionally been strengthened (B).

In contrast, the 1st camshaft bearing and first camshaft journal are still of the old diameter.

- A Camshaft bearing for normal power engines
- B Camshaft bearing for uprated engines

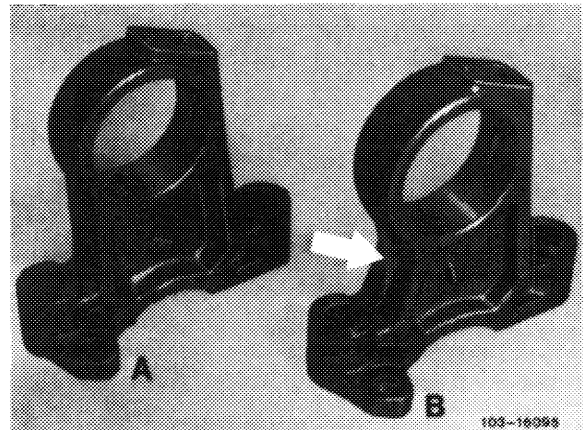

Since camshafts of chilled casting wear better than tempered types, the latter (code Nos. 00 and 02) have been replaced by chilled casting types (code Nos. 06 and 08) in normal power engines 615, 616 and 617 (see table).

These camshafts also match the hard-backed rocker arms.

Chilled casting camshafts (code Nos. 06, 08 and 10) must be used only with hard-backed rocker arms.

Hard-backed rocker arms must not be used with tempered camshafts (code Nos. 00 and 02).

Nor is it possible to install the camshaft from the up-rated engine (code No. 10) in a normal power engine because the valve spring cap would otherwise contact the valve stem seal as the valve opens.

The modification to chilled casting camshafts and hard-backed rocker arms has been accompanied by new cap nuts (B) which are thicker at the top and finished in hard chrome plating.

These nuts can be used with all types of rocker arms.

In contrast, the cap nut without chrome plating must not be used with the hard-backed rocker arm.

- A Cap nut without chrome plating
- B Cap nut, hard chrome plated

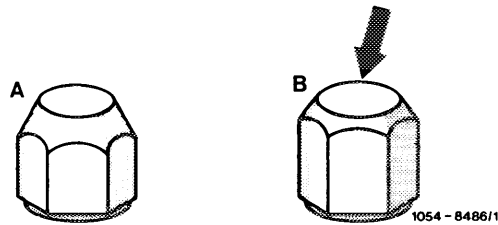

Chilled casting camshafts fracture easily and therefore must not be banged, knocked or thrown.

Replace any camshaft on which the cams show flats (arrow).

Also check the timing of all high-mileage engines (on suspicion of substantial chain stretch) (05-215).

Worn camshaft journals can be reground. The necessary camshaft bearings are available in two repair stages (05-225).

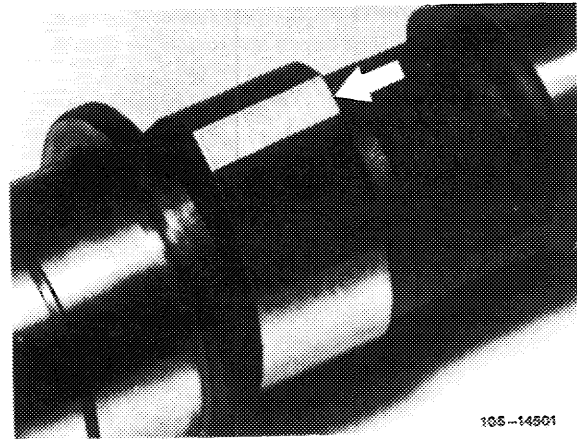

Removal

- 1 Remove cylinder head cover.

On vehicles with automatic transmissions and vacuum-controlled modulating pressure, additionally disconnect vacuum lines at switch-over valve.

Caution:

Be sure not to cross vacuum lines. The pipe unions and vacuum lines are color coded.

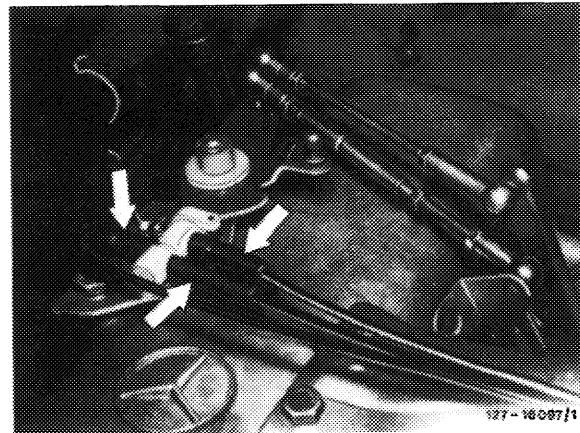

On engines with longitudinal control spindles, detach all control rods. Withdraw retainer (arrow) and force longitudinal control spindle in aft direction. Unscrew bracket (1) and unclip idle control cable (2) with plastic sleeve (3).

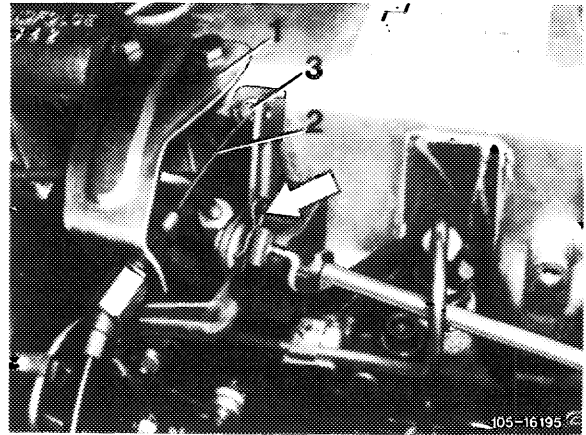

2 Remove rocker arms and rocker arm brackets (05-235).

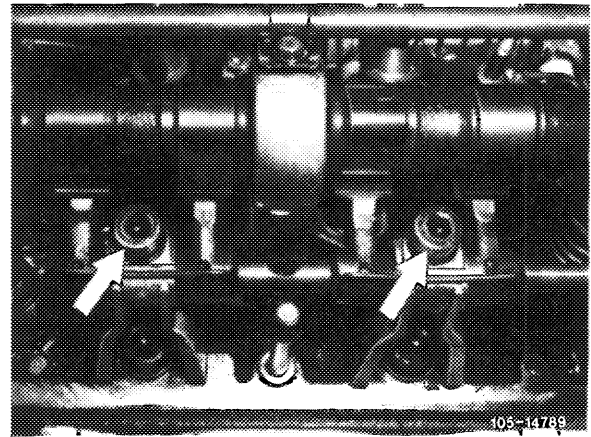

3 Remove slide rail from cylinder head. Withdraw bearing pin, using impact extractor.

On models with level control, remove delivery oil pump together with connected lines, depositing on one side.

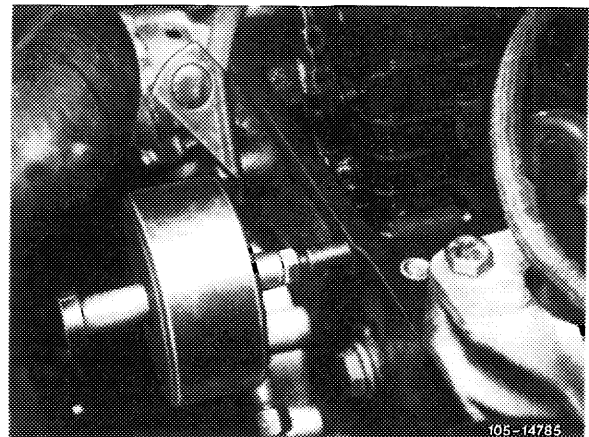
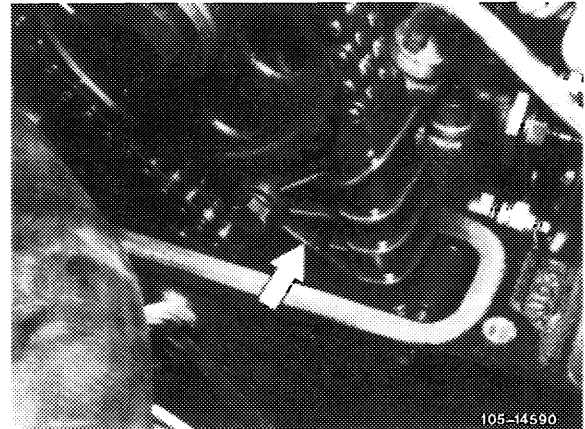

4 On engines with tension rail version (A) remove chain tensioner.

On engines with lightweight tension rail (B) slacken thrust pin of chain tensioner.

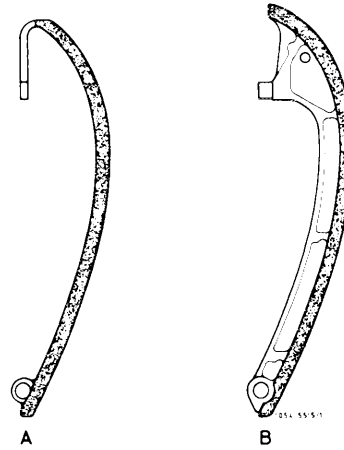

5 Turn crankshaft to firing TDC.

For this purpose turn crankshaft using tool combination.

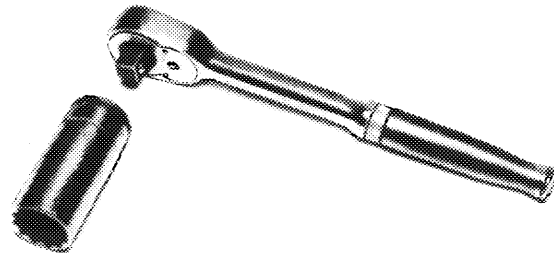

R 100/6498

6 Mark positions of camshaft sprocket and timing chain to show how they fit together.

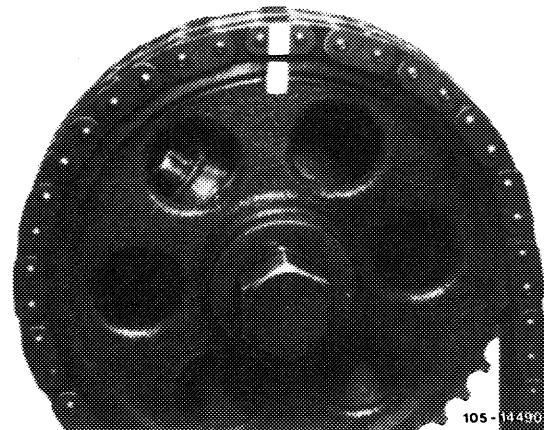

105-11490

7 Remove camshaft sprocket.

To release waisted bolt secure camshaft sprocket with screwdriver or steel pin.

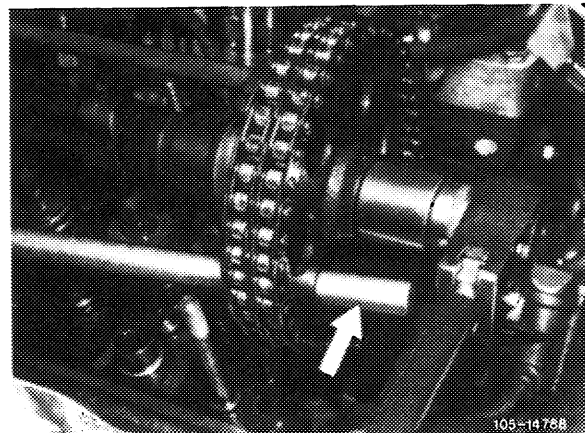

105-14798

8 Remove shim.

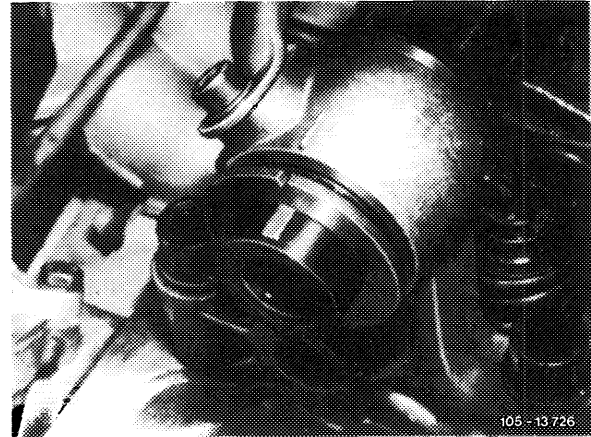

9 Unscrew camshaft bearing bolts, using key wrench (10 mm).

Unscrew M 8 nuts.

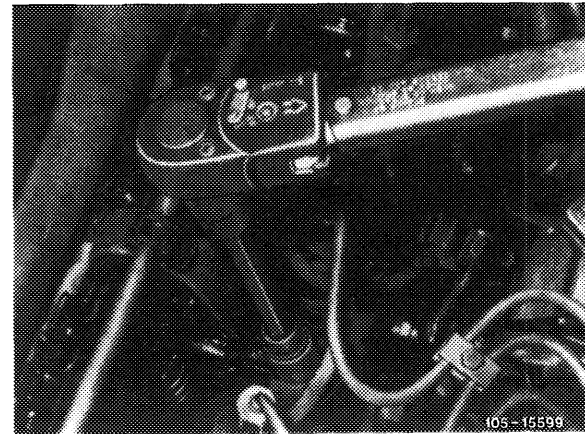

10 Remove camshaft together with camshaft bearings and oil pipe.

Note dowel pins.

Sticking camshaft bearings can be released by gently tapping with a plastic-headed hammer.

11 Draw camshaft out of camshaft bearings in aft direction.

Installation

12 Apply engine oil to camshaft bearings, camshaft journals and cams.

13 Introduce camshaft into camshaft bearings from rear.

14 Fit camshaft with camshaft bearings and oil pipe.

Be sure to note dowel pins.

15 Torque camshaft bearing bolts (cylinder head bolts) from inside to outside in accordance with specifications (see table).

On engines with hexagon socket cylinder head bolts, just slacken the remaining 14 cylinder head bolts **one by one** and torque to 100 Nm (10 kpm). Here again, remember to work from inside to outside.

Torque M 8 nuts to 25 Nm (2.5 kpm).

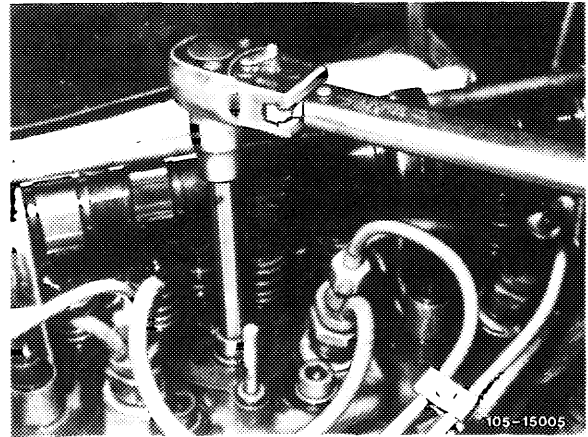

16 Turn camshaft by hand to check for ease of movement.

Proceed as follows if camshaft is **hard** to turn:

Slacken camshaft bearings individually and then turn camshaft each time.

Repeat this procedure until tight bearing is found. Using a surface plate for reference, dress the troublesome camshaft bearings at base (arrows), to account for amount by which camshaft is bent.

17 Slip shim onto journal for camshaft sprocket.

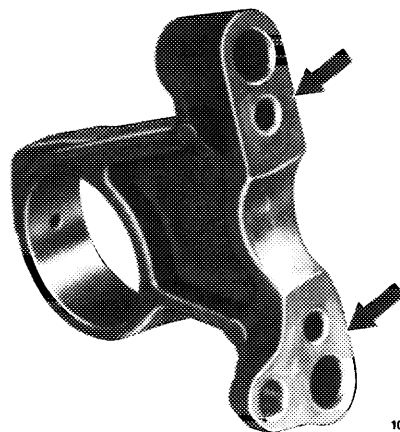

18 Fit camshaft sprocket, noting color coding.

Torque waisted bolt to 80 Nm (8 kpm), securing camshaft sprocket with screwdriver or steel pin for this purpose.

19 Fit slide rail.

20 Install chain tensioner (05-310).

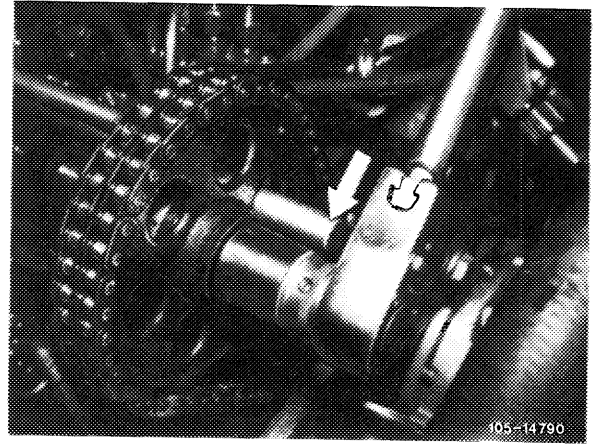

21 Install rocker arms and rocker arm brackets (05-235).

22 Install delivery oil pump for level control system.

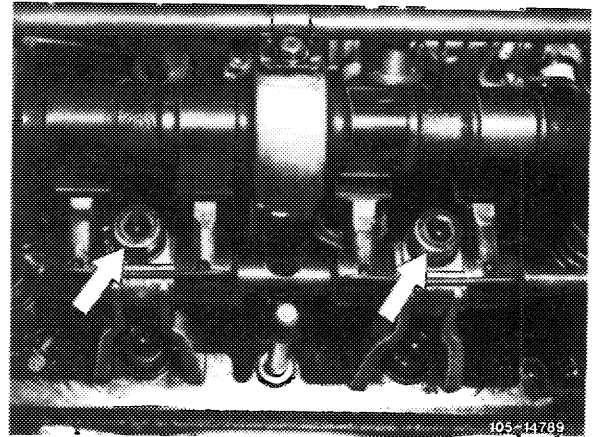

23 Adjust valve clearance (05-210).

24 Fit cylinder head cover.

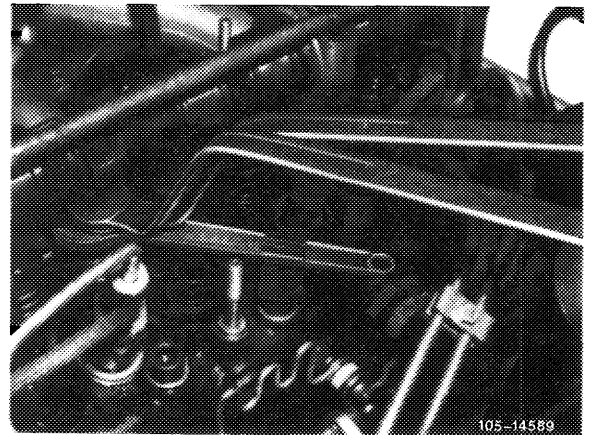

Camshaft and camshaft bearings

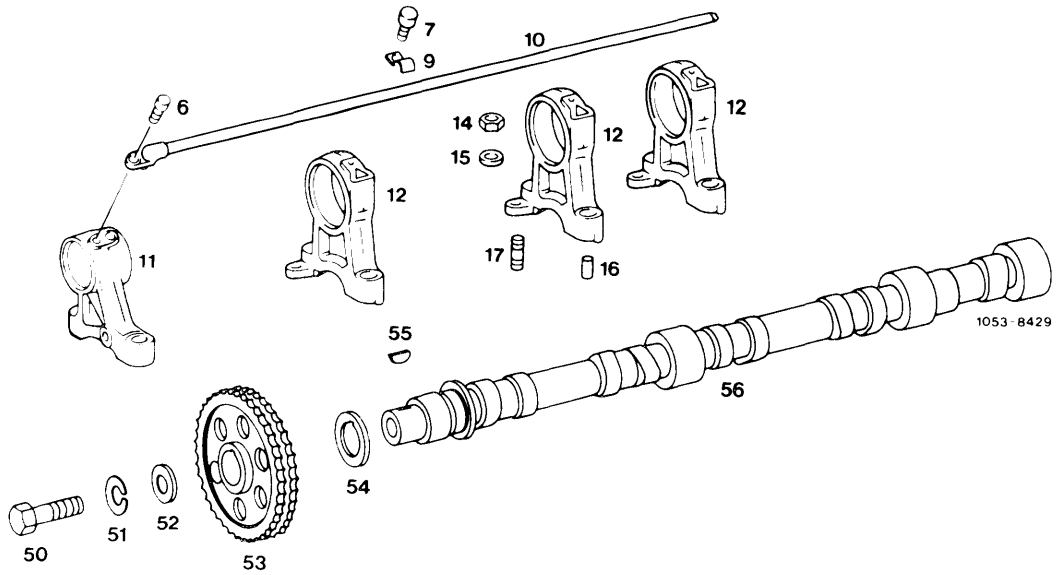

Layout of engine 617

Engines 615 and 616 have one bearing less

6	Screw assembly M 6 x 12	14	4 nuts	52	Washer
7	3 screw assemblies M 5 x 10	15	4 washers 8.4	53	Camshaft sprocket
9	3 clips	16	8 straight pins 8 x 8	54	Shim
10	Oil pipe	17	4 studs M 8 x 18	55	Woodruff key
11	Camshaft bearing, cranking end	50	Waisted bolt M 14 x 1.5 x 40	56	Camshaft
12	Camshaft bearing	51	Lock washer B 14		