



Mercedes-Benz

Electrical Troubleshooting Manual
Passenger Cars
Model Years 1975 – 1979



Mercedes-Benz of North America, Inc.

S-2379-000

© 1989 Mercedes-Benz of North America, Inc.
Mercedes-Benz Canada, Inc.
Service and Parts Literature

All rights reserved. Reproduction or
translation in whole or in part is not
permitted without written authorization
from the publisher. Reprinted 1993.

Printed in the U.S.A.

Order No. **S-2379-000**

HOW TO USE THIS BOOK WITH THE 1978/79 WIRING DIAGRAMS

The Mercedes-Benz *Electrical Troubleshooting Manual* has been modified for 1978/79. The changes and additions are explained in the paragraphs which follow. Unless otherwise stated, the information supplied in the 1977 ETM's is the same.

HOW TO READ THE WIRING DIAGRAMS

The 1978/79 wiring diagrams have been modified in order to simplify understanding and troubleshooting. The following information relates to these modifications.

The *power buses* have been eliminated. The cars do not physically contain power buses; therefore the diagrams reflect the actual wiring instead.

All fuses are shown in only one place on the diagram, together with all the circuits they feed. This feature will save time when following the *six-step troubleshooting procedure*.

All grounds which are terminated with a wire have been labeled with a *T* designation. In this way, together with the *Ground Termination Chart*, you will easily be able to identify all circuits having common grounds.

There are 11 different cars; but only 3 wiring diagrams. This was made possible because of the identical fusing for each model having the same chassis. All major accessories and ignition systems are shown on separate diagrams and are cross-referenced to the 3 main wiring diagrams.

- Dia. 1 — Main Wiring, Chassis Type 123 (models 240D, 300D, 280E, 280CE, 300CD).
- Dia. 2 — Main Wiring, Chassis Type 116 (models 280SE, 450SEL, 300SD, 6.9).
- Dia. 3 — Main Wiring, Chassis Type 107 (models 450SL, 450SLC).
- Dia. 4 — Automatic Climate Control
- Dia. 5 — Rear Window Heater
- Dia. 6 — Cruise Control
- Dia. 7 — Power Antenna
- Dia. 8 — Power Windows
- Dia. 9 — Heated Seats
- Dia. 10 — Sliding Roof
- Dia. 11 — Air Conditioner/Heater (model 240D)
- Dia. 12 — Glow Plug (models 240D, 300D)
- Dia. 13 — Ignition System (models 280E, 280CE)
- Dia. 14 — Glow Plug (model 300SD)

GROUND TERMINATIONS INDEX

The *Ground Termination Index* lists all the grounds which are terminated by a wire(s) to the frame or chassis of the vehicle. These terminations are illustrated on the wiring diagrams by a standard ground symbol with a circle added on top of it. Each of these terminations are identified with a "T" designation (*T1, T2, etc.*).

The Ground Termination Index lists each ground, which components are terminated for each ground, where each ground is located in the vehicles, and what wiring diagram(s) and coordinates they can be found on (*FIG. NO. LOCATION column*).

The Ground Termination Index contains 5 columns as follows:

MODEL NO. — lists all the model numbers.

GROUND ID NO. — lists the wire ground identification numbers which are found on all the wiring diagrams.







COMPONENTS — lists all the components in alphabetical order which are wire terminations to ground.

FIG. NO. LOCATION — lists the *Figure Number(s)* and *Coordinates* at which the ground(s) can be found. Since Figures 1, 2, & 3 are the only diagrams containing coordinates, a number appearing alone (*without coordinates*), indicates the Figure Number only.

CAR LOCATION — explains where the grounds can be found in the vehicles.

SYMBOLS AND DEFINITIONS

The following symbols have been changed:

-  relay coils, clutch, solenoid
-  wire terminated Ground
-  frame Ground
-  single filament light bulb
-  double filament light bulb
-  female
-  male

SIX-STEP TROUBLESHOOTING PROCEDURE

STEP 1: Verify the Complaint

Check the customer complaint to determine if a problem really exists. Road test it, and if possible, have the customer show you what happens. If the problem exists, note the symptoms.

Positive Symptom — the component functions normally. Example: the horns blow when the horn ring is depressed.

Negative Symptom — the component does not function normally. Example: the horns do not blow when the horn ring is depressed.

STEP 2: Determine Related Symptoms

Determining related symptoms is a very important step. It will save you much time in the long run.

In order to obtain additional information about *where* the problem exists, related symptoms are found by conducting *operational checks* on circuits which are connected to the problem circuit. Operational checks are made *without* the use of test equipment. Your most important tool will be the wiring diagram. For example, refer to Fig. 1:

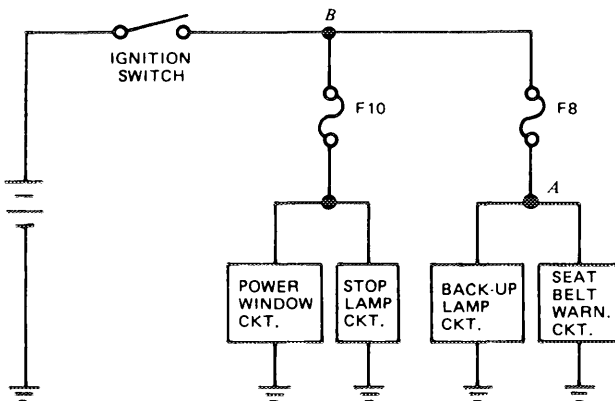

Figure 1

If the customer complaint was that the Back-Up Lamps didn't work, you would trace the circuit starting at ground at the back-up lamps until you reach the first common point (A). The seat belt warning circuit is also connected to point (A); therefore you should conduct an operational check on the seat belt warning circuit to see if it operates correctly. If it does (*positive symptom*), you would then proceed to step 3 in the troubleshooting procedure. If the seat belt circuit did not operate, you would then continue tracing the circuit towards the battery until you reach the next common point (B). The power windows or stop lamps are connected to point B; therefore you should check to see if either of them are working. If it works, you would then proceed to step 3.

STEP 3: Analyze the Symptoms

After conducting operational checks (*step 2*), the trouble will always lie between a check which resulted in a *negative* symptom, and a check which resulted in a *positive* symptom. Consider the following examples (*refer to Dia. 1*):

EXAMPLE 1: If the back-up lamps did not work; but the seat belt warning circuit worked, the trouble would lie between point A and ground at the back-up lamps.

EXAMPLE 2: If the back-up lamps and seat belt warning circuits didn't work; but the stop lamps worked, the trouble would lie between point B and ground.

In example 1 above, the trouble would be an *open*, since a short would have caused fuse F8 to blow open.

In example 2 above, the trouble may be a *short*. Fuse F8 may have opened due to a short in either the back-up lamp or seat belt warning circuits.

After analyzing the symptoms, you would then develop a plan to isolate the trouble. There are 3 things to consider:

1. What goes wrong most of the time? Some parts receive more use than others and therefore wear out sooner. Other parts are subjected to corrosion, while others are just natural trouble spots.
2. Check parts which are closest to you. This will save time. Simple tests should be made first.
3. How difficult the parts are to get to in order to perform tests on them determines the order in which they are checked. Leave the more difficult places until last. There is no substitute for common sense.

In order to work efficiently in isolating a trouble, you should make the least number of checks possible. To do this, you should use the *split-half* technique. In this technique, each check that you make should split the problem area in half. Decide *which* checks to make, *what* test equipment to use, and *what* the normal readings should be.

STEP 4: Isolate the Trouble

Follow your plan. After making the first isolation check (*using test equipment*), note if your results were normal (*positive symptom*); or abnormal (*negative symptom*). If the results were abnormal, select another check which would split the problem area in half. Keep doing this until the problem is isolated.

STEP 5: Correct the Trouble

Replace, repair, or adjust as specified by the manufacturer.

STEP 6: Check for Proper Operation

Make sure that the customer complaint is satisfied, and that everything works the way it is supposed to. Perform the same checks as in Step 1. All symptoms should be *positive*.

COMPONENT INDEX

The *Component Index* lists in alphabetical order, all the electrical components which are equipped in each of the 12 models.

In order to locate a component on a wiring diagram(s), merely locate the component in the left column under *COMPONENT*. Then, move across to the *MODEL* column. The number(s) appearing at the intersection relate to the *Diagram Number* and *Coordinates* which the components can be found. Since *Diagrams 1, 2, & 3* are the only diagrams containing coordinates, a number appearing alone (*without coordinates*), indicates the *Diagram Number* only. A dash (–) indicates that the component is *not* in a particular model.

EXAMPLE: If you wanted to locate the *Alternator* in *Model 300D*:

1. Locate *Alternator* under the column labeled *COMPONENT*.
2. Move across to the right until you reach the column labeled *300D*.
3. At the intersection between the two columns you should find: *1-2C, 12*. This means that the *Alternator* can be found on *Diagram 1, coordinate 2C*; and also on *Diagram 12*.