

**MODEL 107.045**

**380 SL**

# HOW TO USE THIS MANUAL

## How To Read Schematic Diagrams

Electrical components which work together are shown together. Schematic drawings are arranged so that current flows from positive at the top of the page, to negative at the bottom. Fuses are shown at the top of the page. All wires, connectors, switches and motors are shown in the flow of current to ground at the bottom of the page. The "HOT" labels appearing at the top of fuses or components show the ignition/starter switch positions which supply power to the point (see Circuit Identification, page 12).

The terminal number "30" appearing on the ignition/starter switch and exterior and exterior lamp switch means that these terminals are always supplied with power. The terminal number "15" on the ignition/starter switch means that this terminal is supplied with power only when the ignition/starter switch is in the "Run" or "Start" positions.

## Components and Wire Representation

All wiring between components is shown exactly as it exists on the vehicle. Wiring inside complicated components has been simplified to aid in understanding their electrical operation. Transistorized components are shown as plain boxes labeled with a solid state symbol. Switches and sensors are shown "at rest", as if the ignition/starter switch were off. Notes are included which describe how switches and other components work.

## Circuits Which Share Power and/or Grounds

Each circuit is shown completely on one schematic diagram. wires common to different schematics are cross referenced and marked with arrows. To find other circuits which might share fuse terminals or screw terminal blocks, look on the Power Distribution or Fuse Block Details schematics. To find other circuits which might share connections to ground terminals, look on the Ground Distribution schematics.

## Power Distribution and Ground Distribution Schematics

The power distribution diagrams show connections from the battery and alternator to the fuses, to the ignition/starter switch and to the exterior lamp switch. This will tell you how each circuit gets its power, and what circuits share common fuses.

Ground distribution diagrams show how several circuits are connected to common grounds.

## Component Identification

Component names are found underlined next to or above each component. Above the component name, you will find a component identification number.

# SYMBOLS

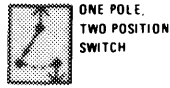

ONE POLE, TWO POSITION SWITCH

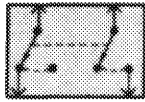

SWITCHES THAT MOVE TOGETHER  
DASHED LINE SHOWS A MECHANICAL CONNECTION BETWEEN SWITCHES

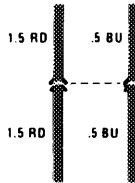

TWO CONNECTIONS (PINS) IN THE SAME CONNECTOR  
DASHED LINE SHOWS PARTS OF THE SAME CONNECTOR

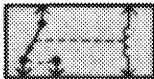

RELAY SHOWN WHEN COIL IS ENERGIZED, SWITCH IS PULLED CLOSED  
WITH NO CURRENT FLOWING THROUGH COIL

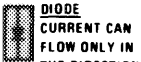

DIODE CURRENT CAN FLOW ONLY IN THE DIRECTION OF THE ARROW

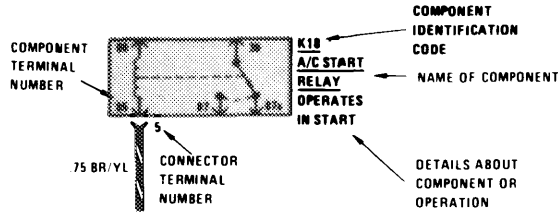

WIRE INSULATION	
COLOR	ABBREVIATIONS
BLACK	BK
BROWN	BR
RED	RD
YELLOW	YL
GREEN	GN
BLUE	BU
VIOLET	VI
GRAY	GY
WHITE	WT
PINK	PK

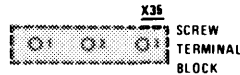

SCREW TERMINAL BLOCK



TWO PARTS OF THE SAME COMPONENT

WIRE SIZE CONVERSION CHART	
METRIC CROSS SECTIONAL AREA IN MM <sup>2</sup>	AWG (AMERICAN WIRE GAUGE)
5	20
7.5	18
1	16
1.5	14
2	14
2.5	12
4	10
6	8
8	8
16	4
20	4
25	2
32	2

ALL MODELS

TWO POLE, FOUR POSITION SWITCH

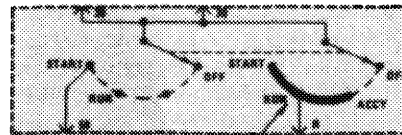

"R" IS ENERGIZED IN ACCY. RUN OR START



OTHER CIRCUITS ALSO GROUND AT W1

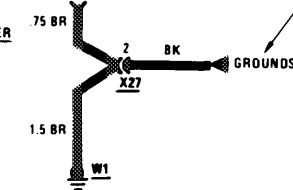

REVISIONS.

# SYMBOLS

MY 1983/MY 1984/MY 1985



ENTIRE COMPONENT SHOWN



PART OF A COMPONENT SHOWN



COMPONENT WITH SCREW TERMINALS

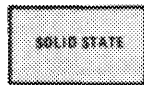

TRANSISTORIZED COMPONENT

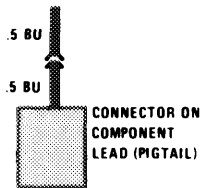

CONNECTOR ON COMPONENT LEAD (PIGTAIL)

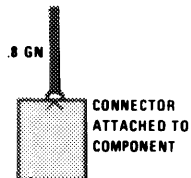

CONNECTOR ATTACHED TO COMPONENT

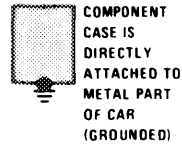

COMPONENT CASE IS DIRECTLY ATTACHED TO METAL PART OF CAR (GROUNDED)

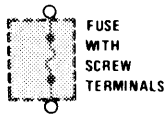

FUSE WITH SCREW TERMINALS

HOT AT ALL TIMES  
INDICATES THAT FUSE 4 IS ALWAYS SUPPLIED WITH POWER

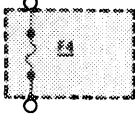

HOT IN RUN OR START  
INDICATES THAT FUSE 4 IS SUPPLIED WITH POWER WITH THE IGNITION SWITCH IN THE RUN OR START POSITIONS

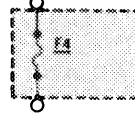

WIRE CHOICES FOR OPTIONS ARE SHOWN AND LABELED

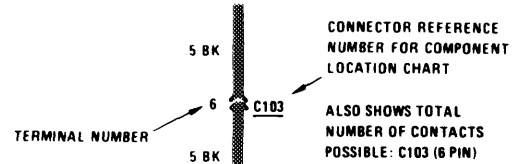
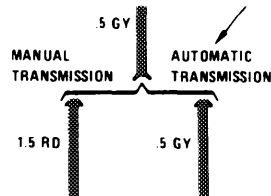

CONNECTOR REFERENCE NUMBER FOR COMPONENT LOCATION CHART

ALSO SHOWS TOTAL NUMBER OF CONTACTS POSSIBLE: C103 (6 PIN)

WIRE INSULATION IS ONE COLOR



A WAVY LINE MEANS A WIRE IS TO BE CONTINUED



WIRE INSULATION IS ONE COLOR WITH ANOTHER COLOR STRIPE (RED WITH YELLOW)

WIRE SIZE IN MM<sup>2</sup>

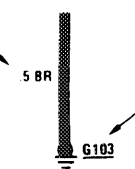

WIRE IS ATTACHED TO METAL PART OF CAR (GROUNDED)

GROUND IS NUMBERED FOR REFERENCE ON COMPONENT LOCATION CHART OTHER CIRCUITS THAT SHARE A GROUND ARE SHOWN IN GROUND DISTRIBUTION

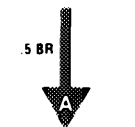

TO TACHOMETER

CURRENT PATH IS CONTINUED AS LABELED. THE ARROW SHOWS DIRECTION OF CURRENT FLOW AND IS REPEATED WHERE CURRENT PATH CONTINUES.

A WIRE WHICH CONNECTS TO ANOTHER CIRCUIT

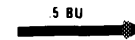

LIGHTS: TURN/HAZARD/STOP

REVISIONS:

SYMBOLS

MY 1983/MY 1984/MY 1985

ALL MODELS

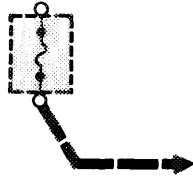

THE FUSE FEEDS OTHER CIRCUITS WHICH ARE NOT SHOWN HERE. THESE CIRCUITS ARE IDENTIFIED IN "POWER DISTRIBUTION."

POWER DISTRIBUTION



CHECK VALVE

VACUUM CAN FLOW EASILY IN THE DIRECTION OF THE ARROW. VACUUM CANNOT FLOW AGAINST THE ARROW.



TEMPERATURE SENSOR



GROUNDS

CIRCUITS NOT SHOWN HERE SHARE THIS GROUND. THESE CIRCUITS ARE IDENTIFIED IN "GROUND DISTRIBUTION."

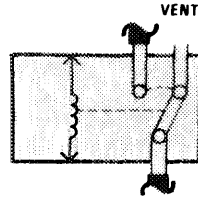

VENT

A SWITCHOVER VALVE IS A SOLENOID OPERATED VACUUM VALVE. THE VALVE IS VENTED WHEN THE COIL OF THE SOLENOID IS DE-ENERGIZED.



INDUCTIVE SENSOR



VACUUM RESTRICTOR

VACUUM RESTRICTORS ARE POROUS BRASS PLUGS IN THE VACUUM HOSE. THE RESTRICTOR SLOWS THE VACUUM FLOW.

NO VACUUM



VACUUM ELEMENTS PUSH OR PULL A SHAFT BETWEEN TWO FIXED POSITIONS. WHEN VACUUM IS APPLIED, THE SHAFT IS PULLED IN. WHEN NO VACUUM IS PRESENT, THE SHAFT IS PUSHED OUT BY A SPRING.

REVISIONS:

# SYMBOLS

AS OF MY 1986

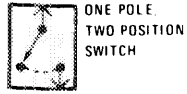

ONE POLE  
TWO POSITION  
SWITCH



SWITCHES THAT  
MOVE TOGETHER  
DASHED LINE SHOWS  
A MECHANICAL  
CONNECTION  
BETWEEN SWITCHES

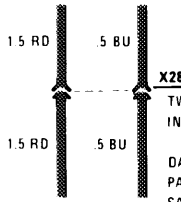

X28  
TWO CONNECTIONS (PINS)  
IN THE SAME CONNECTOR  
DASHED LINE SHOWS  
PARTS OF THE  
SAME CONNECTOR



RELAY SHOWN  
WITH NO  
CURRENT  
FLOWING  
THROUGH  
COIL  
WHEN COIL IS  
ENERGIZED, SWITCH  
IS PULLED CLOSED



DIODE  
CURRENT CAN  
FLOW ONLY IN  
THE DIRECTION  
OF THE ARROW

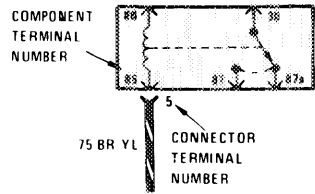

COMPONENT  
TERMINAL  
NUMBER  
CONNECTOR  
TERMINAL  
NUMBER  
K18  
A/C START  
RELAY  
OPERATES  
IN START  
COMPONENT  
IDENTIFICATION  
CODE  
NAME OF COMPONENT  
DETAILS ABOUT  
COMPONENT OR  
OPERATION

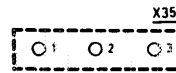

X35  
SCREW  
TERMINAL  
BLOCK



TWO PARTS  
OF THE  
SAME  
COMPONENT

WIRE INSULATION	
COLOR	ABBREVIATIONS
BLACK	BK
BROWN	BR
RED	RD
YELLOW	YL
GREEN	GN
BLUE	BU
VIOLET	VI
GRAY	GY
WHITE	WT
PINK	PK

WIRE SIZE CONVERSION CHART	
METRIC CROSS SECTIONAL AREA IN MM <sup>2</sup>	AWG (AMERICAN WIRE GAUGE)
5	20
7.5	18
1	16
1.5	14
2	14
2.5	12
4	10
6	8
8	8
16	4
20	4
25	2
32	2

ALL MODELS

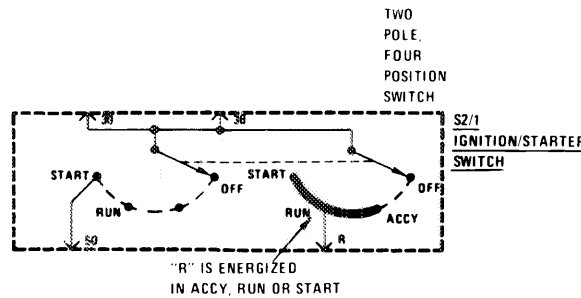

TWO  
POLE,  
FOUR  
POSITION  
SWITCH

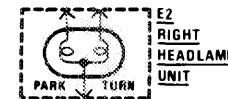

E2  
RIGHT  
HEADLAMP  
UNIT

OTHER CIRCUITS  
ALSO GROUND  
AT W1

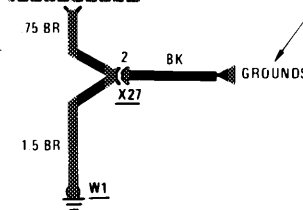

REVISIONS

ALL MODELS



ENTIRE COMPONENT SHOWN



PART OF A COMPONENT SHOWN

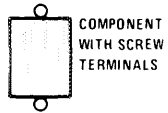

COMPONENT WITH SCREW TERMINALS



TRANSISTORIZED COMPONENT

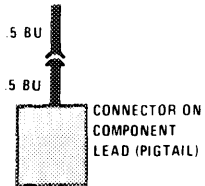

CONNECTOR ON COMPONENT LEAD (PIGTAIL)

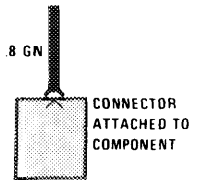

CONNECTOR ATTACHED TO COMPONENT

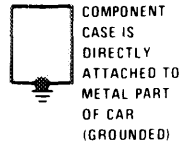

COMPONENT CASE IS DIRECTLY ATTACHED TO METAL PART OF CAR (GROUNDED)

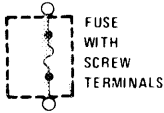

FUSE WITH SCREW TERMINALS

HOT AT ALL TIMES  
INDICATES THAT FUSE 4 IS ALWAYS SUPPLIED WITH POWER

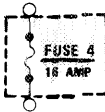

HOT IN RUN OR START  
INDICATES THAT FUSE 4 IS SUPPLIED WITH POWER WITH THE IGNITION SWITCH IN THE RUN OR START POSITIONS

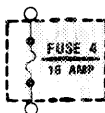

WIRE CHOICES FOR OPTIONS ARE SHOWN AND LABELED

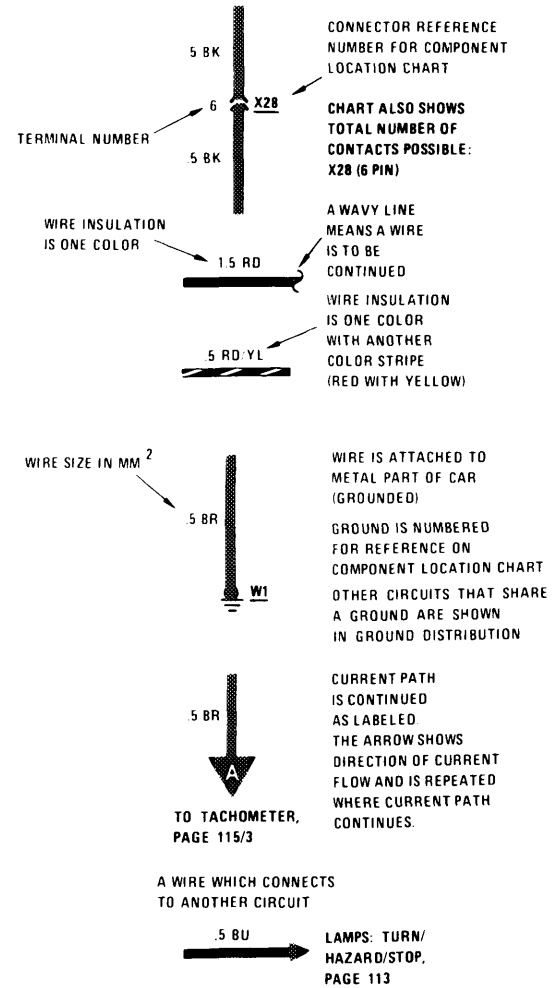
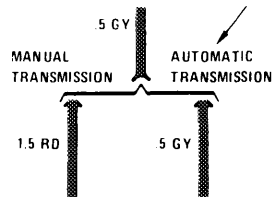

REVISIONS:

# SYMBOLS

AS OF MY 1986

1/87



THIS FUSE FEEDS OTHER CIRCUITS WHICH ARE NOT SHOWN HERE. THESE CIRCUITS ARE IDENTIFIED IN "POWER DISTRIBUTION"

POWER DISTRIBUTION

GROUNDS



CIRCUITS NOT SHOWN HERE SHARE THIS GROUND. THESE CIRCUITS ARE IDENTIFIED IN "GROUND DISTRIBUTION"

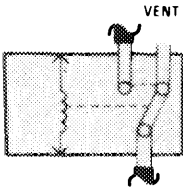

A SWITCHOVER VALVE IS A SOLENOID OPERATED VACUUM VALVE. THE VALVE IS VENTED WHEN THE COIL OF THE SOLENOID IS DE-ENERGIZED.

NO VACUUM

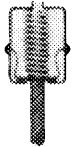

VACUUM ELEMENTS PUSH OR PULL A SHAFT BETWEEN TWO FIXED POSITIONS. WHEN VACUUM IS APPLIED, THE SHAFT IS PULLED IN. WHEN NO VACUUM IS PRESENT, THE SHAFT IS PUSHED OUT BY A SPRING.

ALL MODELS



VACUUM RESTRICTOR

VACUUM RESTRICTORS ARE POROUS BRASS PLUGS IN THE VACUUM HOSE. THE RESTRICTOR SLOWS THE VACUUM FLOW.



INDUCTIVE SENSOR



TEMPERATURE SENSOR

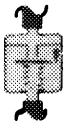

CHECK VALVE

VACUUM CAN FLOW EASILY IN THE DIRECTION OF THE ARROW. VACUUM CANNOT FLOW AGAINST THE ARROW.

REVISIONS:

--



## TROUBLESHOOTING PROCEDURE

## 1. VERIFY THE COMPLAINT

Operate the problem circuit in all modes to check the accuracy of the complaint. This may give a clue as to the extent, nature, and location of the problem.

## 2. CHECK THE FUSE AND RELATED CIRCUITS

Determine the extent of the problem by operating circuits which share the same fuse. If the other circuits work, the fuse is good. The cause must be within the wiring unique to the problem circuit.

## 3. REFER TO THE E.T.M. AND ANALYZE THE CIRCUIT

Study the circuit schematic to learn how the circuit should operate. The schematic will tell you:

- Where the circuit receives current.
- What circuit protection is involved.
- What switches control current flow.
- How the loads operate.

Understanding the total circuit is necessary if you are to troubleshoot efficiently. Determine possible problem areas and testing locations. The Component Location table tells where components and ground points are located.

## 4. SYSTEMATICALLY TEST THE CIRCUIT IN ORDER TO ISOLATE THE PROBLEM

As a general guideline:

- If the fault affects a single component of a circuit, start to test at that component.
- If the fault affects a number of components of a circuit, start to test at the point where the circuit gets its power.

## 5. MAKE THE REPAIR

After you have narrowed the problem down to a specific cause, repair as necessary.

## 6. VERIFY CIRCUIT OPERATION

First operate the repaired circuit in all modes to be sure you have fixed the entire problem. Next, operate all circuits which share the same fuse. Be sure that this does not cause the problem to reappear.

A SERIES AMMETER must never be connected in parallel with a component. This can cause a short circuit and damage the meter.

## TESTING TOOLS

A VOLTMETER is used to measure voltage at various points within a circuit. If an analog VOLTMETER is used, it must have a resistance of at least 20,000 ohms per volt in the low range. Any digital VOLTMETER may be used.

Use of an OHMMETER should be limited to harness wiring, connections and switches. It should not be used on solid state components or relays. An OHMMETER measures a circuit for its resistance to current flow. Since an OHMMETER has an internal battery that provides current to the circuit under test, it is first necessary to disconnect the car battery. This will ensure that there is no voltage already present in the circuit.

An AMMETER measures the current flowing within a circuit. There are two types of AMMETERS: the SERIES AMMETER and the INDUCTIVE (clamp-on) AMMETER (e.g. Sun DMM-5). The INDUCTIVE AMMETER is clamped around a wire in the circuit under test. The SERIES AMMETER must be connected into the circuit.

REVISIONS:

# TROUBLESHOOTING

AS OF MY 1983

## TESTS

### Voltage Test

1. Connect the negative lead of the VOLT-METER to a known good ground or negative (-) battery terminal.
2. Connect the positive lead of the VOLT-METER to a point (connector or terminal) you wish to test.
3. If the meter registers, there is voltage present. This voltage should be within one volt of measured battery voltage. A loss of more than one volt indicates a problem. A loose connection is a likely cause. Take readings at several points along the circuit to isolate the problem.

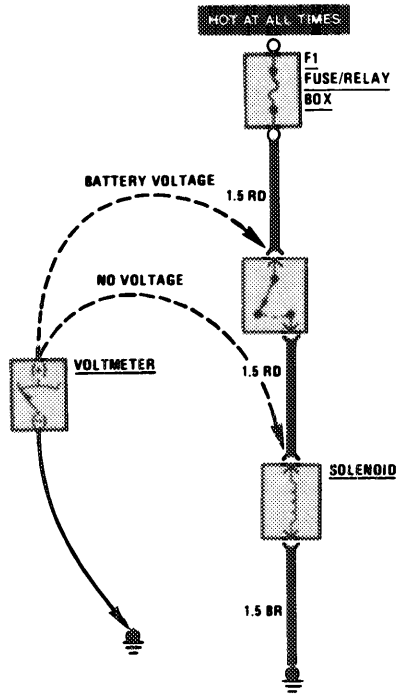

Voltage Test

### Voltage Drop Test

This test checks for voltage being lost along a wire, or through a connection or switch.

1. Connect the positive lead of the VOLT-METER to the end of the wire, or to the side of the connection which is closest to the battery.
2. Connect the negative lead to the other end of the wire, or the other side of the connection.
3. When the circuit is operated, the VOLT-METER will show the difference in voltage between the two points. A difference (or drop) of more than one volt indicates a problem.

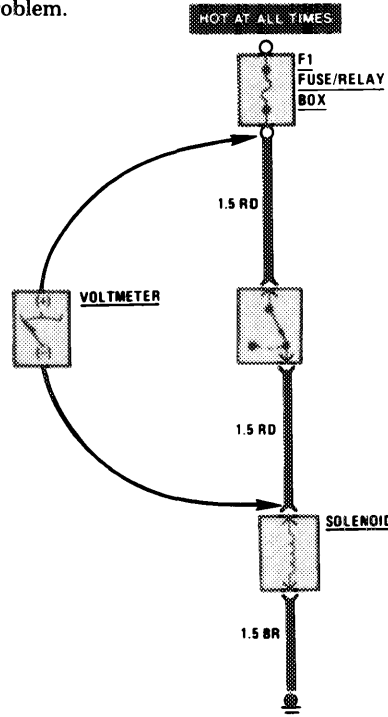

Voltage Drop Test

### Testing For Short to Ground With a Voltmeter

1. Remove the blown fuse and disconnect the load.
2. Connect the VOLTMETER across the fuse terminals.
3. Beginning near the fuse box, move the harness from side to side while watching the VOLTMETER.
4. If the meter registers, there is a short to ground in the wiring.

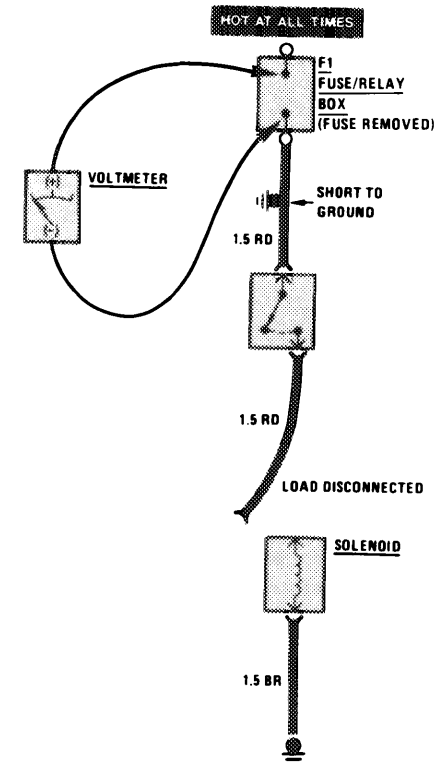

Testing for Short with Voltmeter

REVISIONS:

ALL MODELS

**Continuity Test**

1. Check OHMMETER by adjusting the needle to zero while holding the leads together.
2. Disconnect the car battery.
3. Connect one lead of the OHMMETER to one end of the part of the circuit you wish to test.
4. Connect the other lead to the other end.
5. If the meter shows low or no resistance, there is continuity.

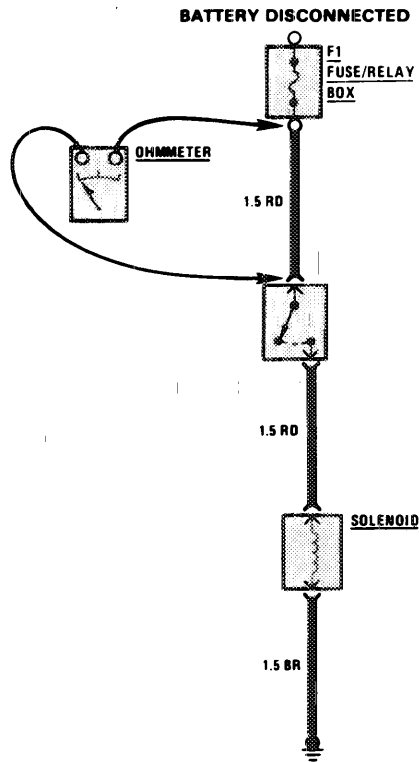

Continuity Test

**TROUBLESHOOTING**

**Testing For Short to Ground With an Ohmmeter**

1. Calibrate OHMMETER by adjusting the needle to zero while holding the leads together.
2. Remove the blown fuse and disconnect the battery and load.
3. Connect one lead of the OHMMETER to the fuse terminal on the load side.
4. Connect the other lead to a known good ground.
5. Beginning near the fuse box, move the harness from side to side, while watching the OHMMETER.
6. If there is no short, the meter will show infinitely high resistance. If the meter registers low or no resistance, there is a short to ground in the wiring.

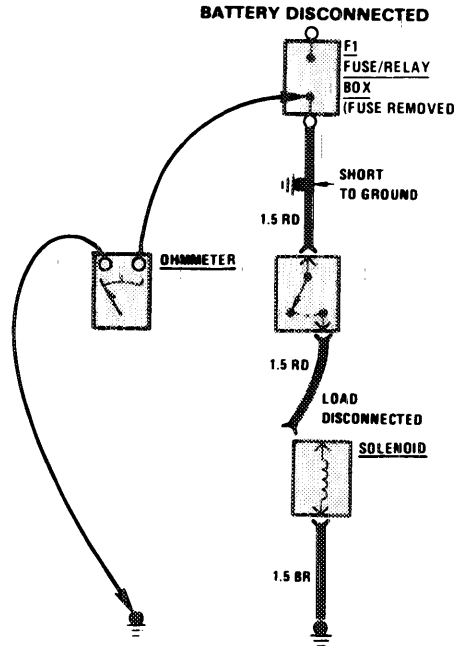

Testing for Short with Ohmmeter

**AS OF MY 1983**

**Current Test With a Series Ammeter**

1. Disconnect the circuit at a convenient point such as a connector.
2. Connect a lead of the AMMETER to one side of the open circuit.
3. Connect the second lead of the AMMETER to the other side of the open circuit. The AMMETER completes the circuit.
4. With the circuit operating, the AMMETER will show how much current is flowing in the circuit.

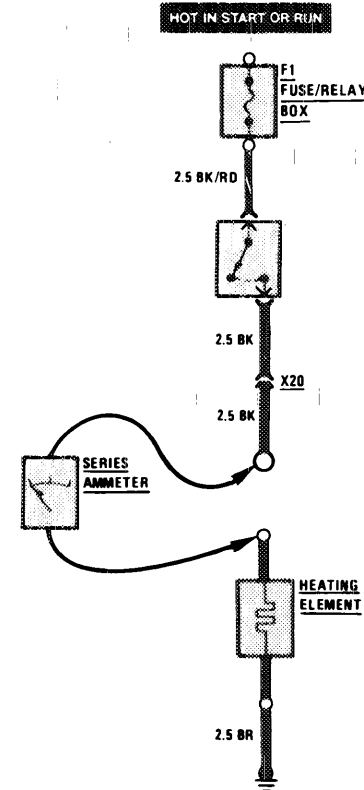

Current Test (Series Ammeter)

REVISIONS:

## TROUBLESHOOTING

AS OF MY 1983

### Current Test With an Inductive Ammeter

1. Clamp the AMMETER pliers around the wire under test in the circuit.
2. With the circuit operating, the AMMETER will show how much current is flowing in the circuit.

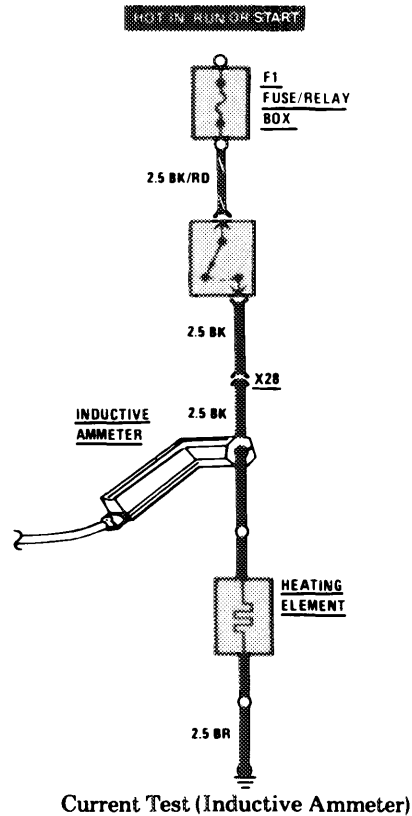

### Troubleshooting Vacuum Components

A VACUUM TESTER is used to apply vacuum to vacuum components. The tester (M-B part no. 589 25 2100) registers in mbar of vacuum. Two typical applications of this tester are shown below.

PERMISSIBLE LEAKS	
Check Valves	50 mbar in 10 min. at 300 mbar vacuum
Other Vacuum Components	20 mbar/min. at 300 mbar vacuum

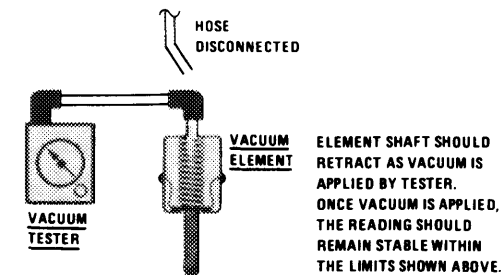
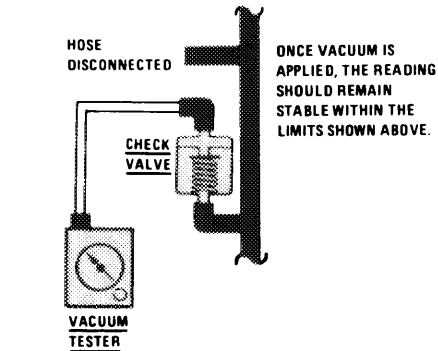

### Switchover Valves (as of MY 1984)

The former switchover valves on all models are replaced by a standard switchover valve.

When de-energized (no current), the side and the lower pipes are connected to each other. When energized, the upper pipe connects to the side pipe. If only two pipes are used, a standard protective cap with vent is plugged onto the third pipe.

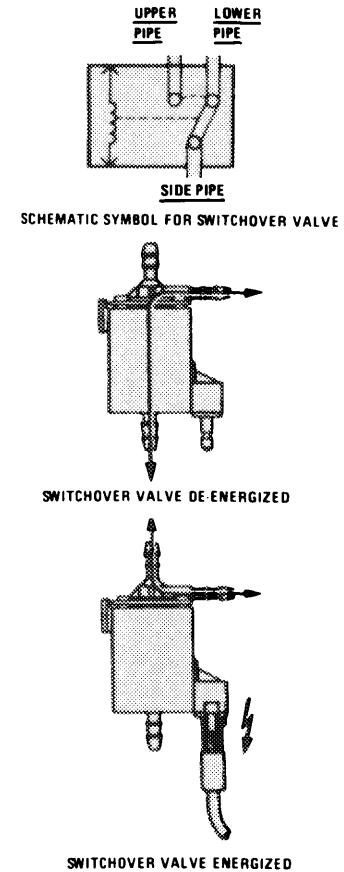

REVISIONS:

## CIRCUIT IDENTIFICATION

AS OF MY 1983

Circuit	Description		Description
1	Negative side of ignition coil (low voltage).	58L	Parking, tail, side marker lamps; left side.
4	Output of ignition coil (high voltage).	58R	Parking, tail, side marker lamps; right side.
15	Battery voltage; ignition/starter switch in "Run" (pos. 2) of "Start".	58N	Fog lamps.
15R	Battery voltage; ignition/starter switch in "Accy" (pos. 1), "Run" (pos. 2) or "Start".	61	Charge indicator.
15R/30	Power feed for Power Seat Motors and Telescopic Steering Wheel.	85	Relay winding; ground side.
15X	Battery voltage; ignition/starter switch in "Run" (Pos. 2).	86	Relay winding; positive side.
16	Ignition switching unit connection from negative side of coil.	87	Relay output; normally open.
30	Battery voltage; "hot" at all times.	87a	Relay output; normally closed.
31	Ground.	K, K30	Battery voltage; exterior lamp switch in "Parking" or "Headlamp" position.
31b	Switched ground.	L	Turn signal lamps; left side.
49	Turn signal/hazard flasher input.	LA	Preglow indicator.
49a	Turn signal/hazard flasher output.	N	Fog lamp switch; output.
50	Starter motor control.	NSE	Fog lamp switch; input.
56	Power feed for headlamps.		Battery voltage with exterior lamp switch in "Parking" or "Headlamp" position.
56a	Headlamps; high beam and indicator lamp.	P30	Power feed for R and L standing lamps; battery voltage with ignition/starter switch in "Off" or "Accessory" position.
56b	Headlamps; low beam.	R	Turn signal lamps; right side.
56d	Headlamp flasher.	TD	Engine speed signal.
58D	Instrument lamp output; from Electronic Control Unit.		NOTE: Circuit identification numbers will appear on schematics inside component boxes. Connector terminal numbers will appear on schematics outside component boxes.
58d	Instrument lamp output; from Rheostat.		

REVISIONS: