

## 07.3–120 Checking fuel pressures and for internal leaks

Job No. of flat rates or standard texts and flat rates data 07–1503.

### A. Basic version

#### Standard

#### Standard KAT (open-loop)

#### Scope

Checking all fuel connections for leaks.  
 Checking air flow sensor plate and control piston for easy operation.  
 Checking control piston for leaks.  
 Connecting pressure measuring device.  
 Checking control pressure cold at idle.  
 Checking system pressure at idle.  
 Checking control pressure warm at idle.  
 Checking voltage and resistance on warm-up compensator.  
 Checking full load enrichment.  
 Checking acceleration enrichment (engine 116.962/963, 117.962/963 only).  
 Checking fuel distributor and fuel pump for leaks.

#### Test values in bar gauge pressure

Engine	116.960/961 117.960/961	116.962/963 117.962/963	
System pressure at idle with engine cold or at operating temperature	5.0–5.6		
Control pressure at idle with engine at operating temperature	Warm-up compensator stabilized	3.4–3.8 at 530 mbar <sup>1)</sup>	3.4–3.8 intake manifold vacuum independent
	Full load enrichment at idle (vacuum hose pulled off)	2.6–3.0	—
	Full load enrichment with engine stopped	—	2.6–3.0
	Acceleration enrichment at idle (both vacuum hoses pulled off)	—	
Control pressure according to ambient temperature at idle with cold engine	min. 0.5 (refer to diagram)		

<sup>1)</sup> If the control pressure is not attained, check intake manifold vacuum (section "Checking control pressure at idle with engine at operating temperature").

## B. Basic version NV KAT (closed-loop)

National version (AUS) (CH) (J) (S) (USA)

### Fuel pressures in bar gauge pressure

National version model year	Information plate	Warm-up compensator Bosch end No.	System pressure at idle with engine cold or at operating temperature	Control pressure at idle with engine cold or at operating temperature		
				Warm-up compensator stabilized at 530 mbar intake manifold vacuum <sup>1)</sup>	Full load enrichment at idle (vacuum hose pulled off)	Acceleration enrichment with engine stopped and 0,5 bar vacuum on warm-up compensator
1981–1985	Color code silver	061, 134	5.0–5.6	3.4–3.8	2.6–3.0	–
1983–1985	Color code green					
1981–1985	Color code blue					
1981–1985	in Japanese	068	5.0–5.6	3.4–3.8	–	1.4–1.8
1981–1985	Color code black					
NV KAT (closed-loop) 1984–1985	–					

<sup>1)</sup> In warm engine the control pressure values depend on intake manifold vacuum, in cold engine on ambient temperature. For this reason, in the event of deviations from nominal value, check intake manifold vacuum or ambient temperature and transmit to respective diagrams.

Transmit control pressure at idle on cold engine according to ambient temperature on diagram.

### Special tools

Pressure measuring device<sup>1)</sup>

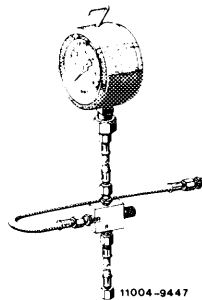

102 589 00 21 00

Clamp for hose lines

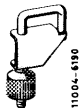

000 589 40 37 00

Hand vacuum pump

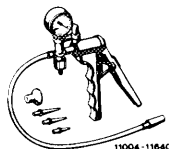

001 589 73 21 00

<sup>1)</sup> The pressure measuring device 100 589 13 21 00 used up to now can be used again.

### Conventional tools

---

Voltmeter, ohmmeter

---

Screw driver element 992-T 30

e.g. Hazet, D-5630 Remscheid

---

### Self-made tool

---

Contact bridge

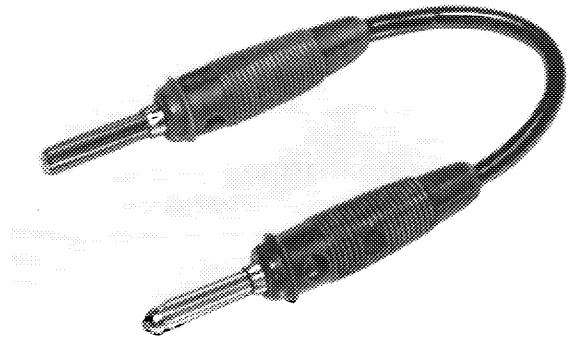

107-19204

---

### Note

---

Perform leak test in the event of complaints about hot start only.

After stopping engine, the fuel pressure should still amount to 2.5 bar gauge pressure after 30 minutes.

## Visual checkup

---

- 1 Remove air cleaner.
- 2 Check all fuel connections for leaks.
- 3 Check adjusting lever (1) in air flow sensor and of control piston (2) in fuel distributor for easy operation. For this purpose, pull off fuel pump relay and bridge the two jacks for a short moment to establish control pressure.

Model year 1981: jacks 1 and 2

Starting model year 1982: jacks 7 and 8

Push air flow sensor plate (4) down manually. A uniform resistance should be felt throughout. No resistance should be felt during quick upward movement, since the slowly following control piston lifts off from adjusting lever. During slow upward movement the control piston should closely follow.

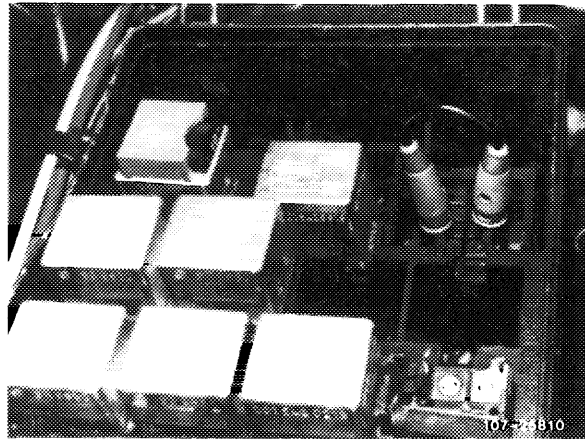
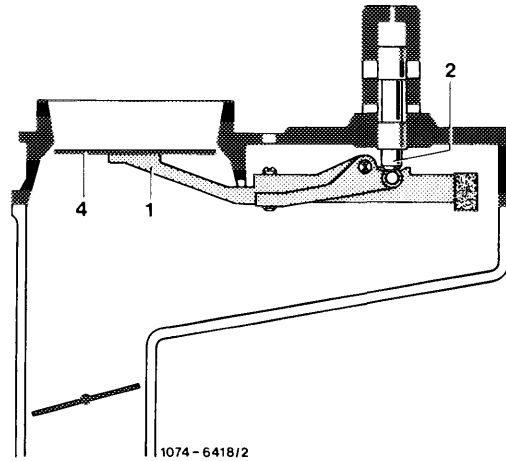

- 4 Check control piston in fuel distributor for leaks, push air flow sensor plate down for a short moment and hold in this position, no fuel should show up in air guide housing.

If fuel flows out, renew fuel distributor (07.3-205).

## Connecting pressure measuring device

---

The pressure measuring device remains connected for all pressure measurements. To relieve sealing rings, keep valve screw or valve screws always opened. Connections of three-way valve are numbered.

Pressure measuring device 1st version

Connection 1 = Hose line on fuel distributor

Connection 2 = Hose line on pressure gauge

Connection 3 = Hose line on released control pressure line

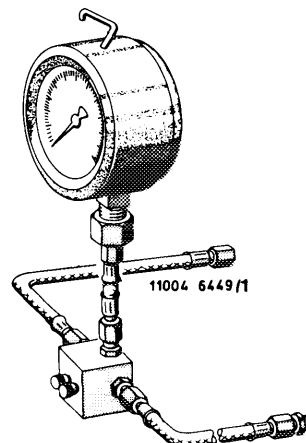

Pressure measuring device 102 589 00 21 00 is now provided with one valve screw on three-way valve only.

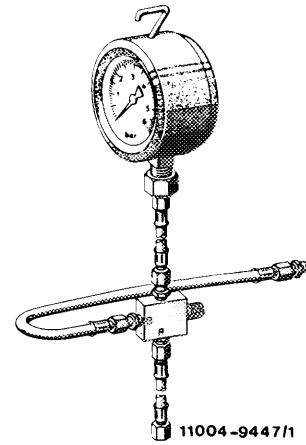

Pressure measuring device 2nd version

Connection A = Hose line on fuel distributor

Connection B = Hose line on released control pressure line

The pressure measuring device can be connected to warm-up compensator or to fuel distributor.

a) Connect pressure measuring device to warm-up compensator (air cleaner mounted).

Unscrew control pressure line (arrow) on warm-up compensator, while catching fuel with a rag.

Connect hose line with double thread connection of connection "1 or A" to control pressure line. Screw connecting line of connection "3 or B" to warm-up compensator.

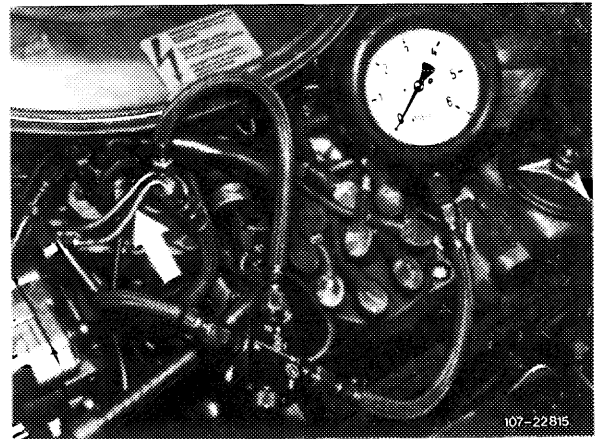

b) Connect pressure measuring device to fuel distributor (air cleaner removed).

Unscrew control pressure line (arrow) on fuel distributor, while catching fuel with a rag.

Connect hose line of connection "1 or A" to fuel distributor and connect hose line of connection "3 or B" to control pressure line (arrow).

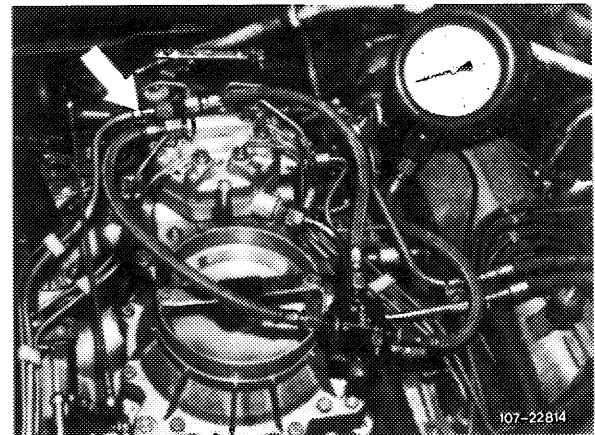

### **Checking control pressure at idle with engine cold**

1 Open valve screw or valve screws on pressure measuring device.

2 Run engine at idle and immediately read control pressure.

Take nominal pressure in accordance with ambient temperature from control pressure diagram. If the nominal value is not attained, recondition system pressure regulator (07.3-210) or check inlet strainer in warm-up compensator. Renew warm-up compensator, if required.

**AUS** **S** starting 1981

**CH** starting 1983

Warm-up compensator Bosch end No. 061

**Example:**

Ambient temperature +20 °C = control pressure  
1.6–2.0 bar gauge pressure.

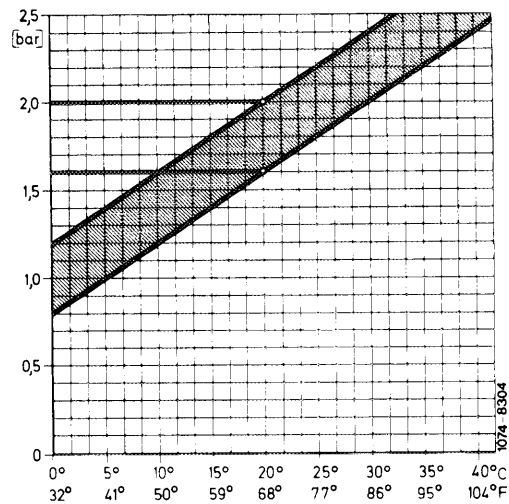

**Basic version NV KAT (closed-loop)**

**J** **USA** starting 1981

Warm-up compensator Bosch end No. 068

**Example:**

Ambient temperature +20 °C = control pressure  
1.8–2.2 bar gauge pressure.

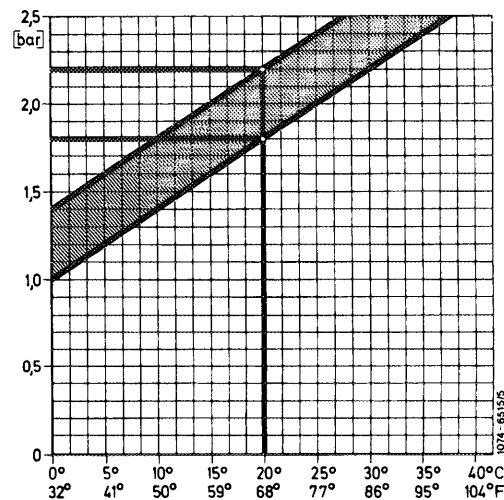

**Note:** Check stabilizing time of warm-up compensator.  
Read initial control pressure at +20 °C. At 3.4 bar,  
gauge pressure, stabilizing time should be within  
tolerance.

All additional electrical consumers switched off and a  
minimum voltage of 12 Volts.

**Checking system pressure at idle with engine cold or at  
operating temperature**

---

3 Close valve screw on pressure measuring device. On  
pressure measuring device with 2 valve screws, close  
valve screw on connection 3.

4 System pressure should amount to 5.0–5.6 bar  
gauge pressure.

5 If the system pressure of 5.0–5.6 bar gauge pressure is not attained or exceeded, perform the following checkups:

- a) Checking fuel pump (07.3–130).
  - b) Recondition system pressure regulator (07.3–210).
  - c) Check fuel return line for passage.
- 6 Re-open valve screw.

#### Checking control pressure at idle with engine at operating temperature

---

7 Open both valve screws or valve screw on pressure measuring device.

8 Control pressure should increase to 3.4–3.8 bar gauge pressure (warm-up compensator stabilized).

If the control pressure of 3.4–3.8 bar gauge pressure is not attained, perform the following checkups:



a) Check intake manifold vacuum. For this purpose, pull vacuum hose from warm-up compensator and attach a T-fitting for pressure gauge.

Read intake manifold vacuum and transfer to vacuum diagram.

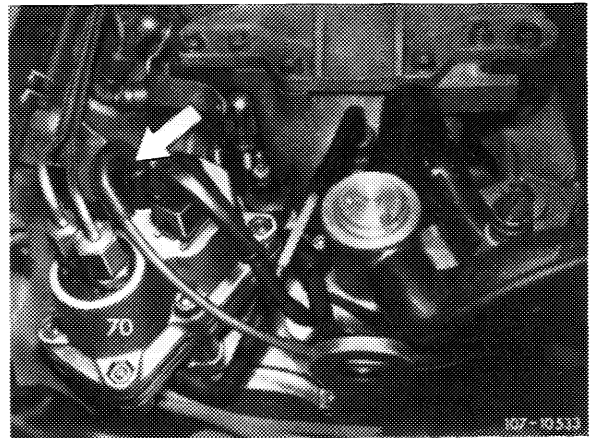

#### Example:

Intake manifold vacuum 400 mbar = 3.5–3.9 bar gauge pressure.

#### Basic version NV KAT (closed-loop)



The control pressure is not influenced by vacuum through change on warm-up compensator.

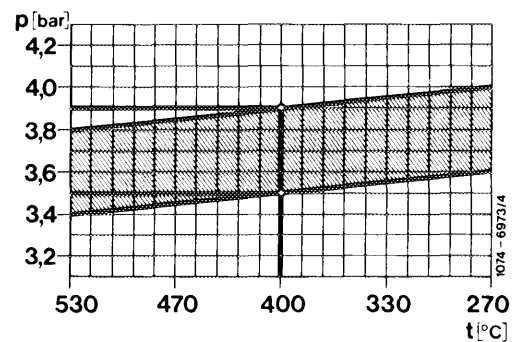

b) Check voltage on warm-up compensator with engine running. Pull electrical connection from warm-up compensator and check voltage. Minimum voltage 12 volts (without electrical consumers).

c) Check heater coil with an ohmmeter.

Renew arm-up compensator if interrupted.

Model year 1981

- 1 Fuel pump relay
- 3 Warm-up compensator
- e To fuel pump

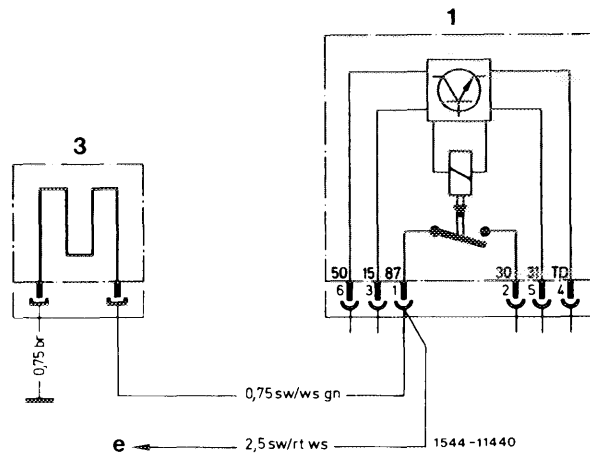

Starting Model year 1982

- 6 Warm-up compensator
- 13 Fuel pump relay
- e To fuel pump

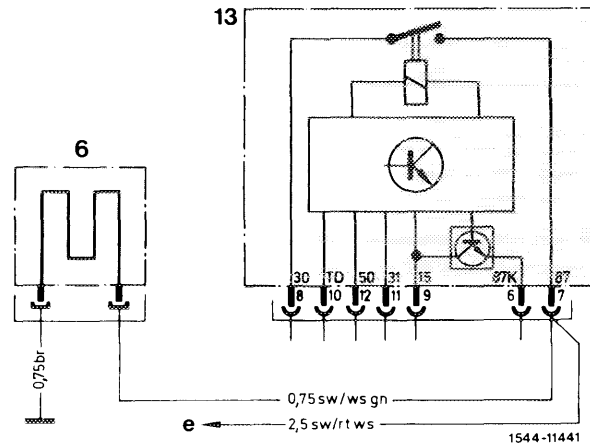

d) If the control pressure is above 3.8 bar gauge pressure, recondition system regulator (07.3-210).

**Check full load enrichment** (AUS) (CH) (S)

9 Pull vacuum hose from warm-up compensator, control pressure should now drop to 2.6-3.0 bar gauge pressure.

Renew warm-up compensator if the control pressure is not attained.

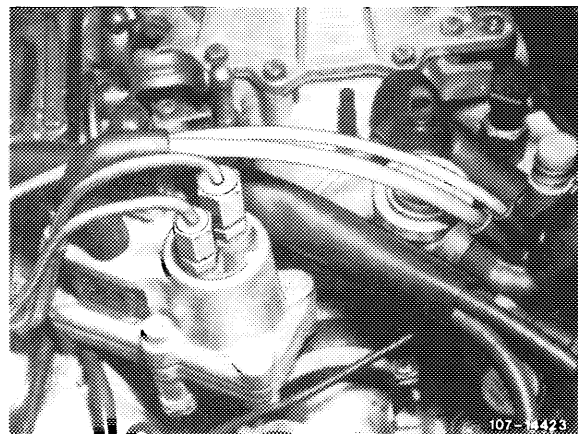

**Checking acceleration enrichment**

Basic version NV KAT (closed-loop), (J) (USA)

10 Check thermovalve 50 °C (37) for passage. For this purpose, pull off vacuum hose (arrow), below approx. 50 °C coolant temperature the thermovalve is closed, above approx. 50 °C temperature passage must be available. If not, renew thermovalve (37).

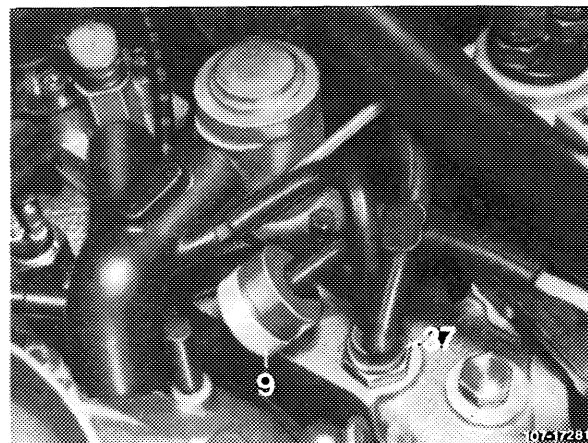



Check orifice (9) for passage. Stop engine. Pull black vacuum line from upper chamber of warm-up compensator. On 4-point distributor, disconnect connection to thermostatic valve. Start engine, control pressure should drop to 1.4–1.8 bar. If not, renew orifice.

11 Run engine until warm-up compensator is stabilized (3.4–3.8 bar gauge pressure).

12 Stop engine. Pull off fuel pump relay.

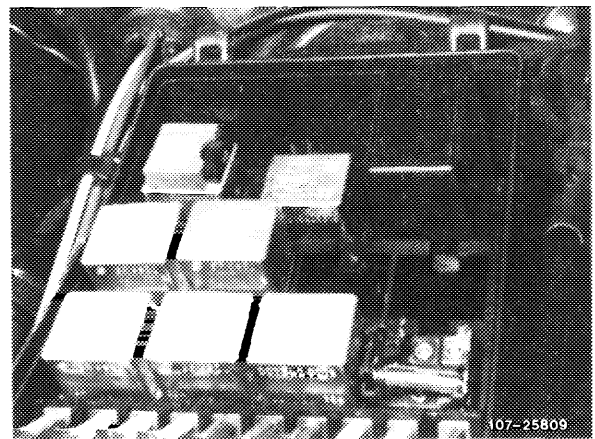

13 Pull vacuum line of vacuum chamber from warm-up compensator (2).

14 Plug on vacuum pump at contour hose (arrow) and energize warm-up compensator with 0.5 bar vacuum.

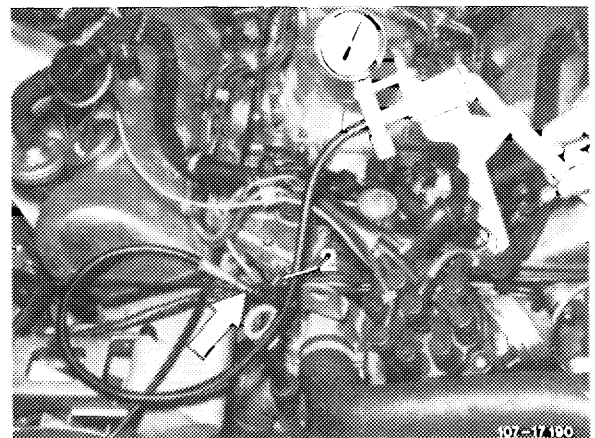

15 Bridge jacks 1 and 2 or 7 and 8.

Model year 1981: jacks 1 and 2.

Starting model year 1982: jacks 7 and 8.

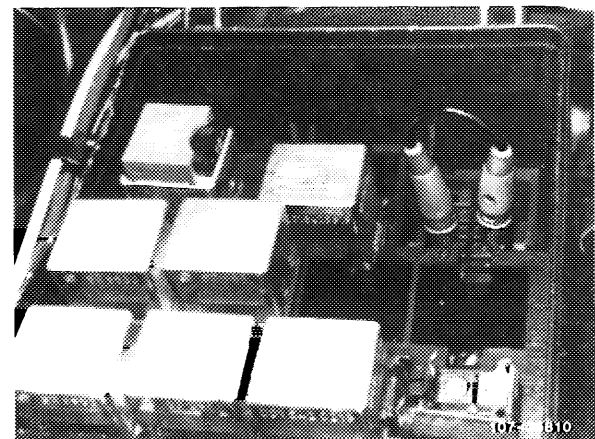

16 Control pressure should then amount to 1.4–1.8 bar gauge pressure. If control pressure deviates from nominal value, renew warm-up compensator.

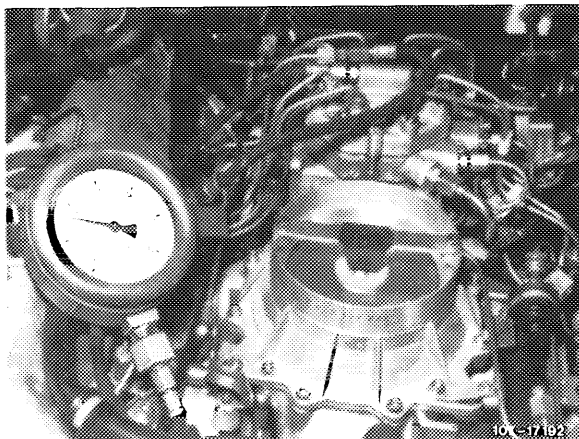

### Checking fuel distributor and fuel pump for leaks

17 Stop engine. Control pressure will now drop below opening pressure of injection valves (approx. 2.8 bar gauge pressure).

18 If the control pressure drops immediately to 0 bar gauge pressure, renew check valve on fuel pump or subsequently install.

19 If the pressure drops slowly, unscrew fuel return line from fuel distributor. In the event of a leak on control piston or pressure compensating valve, fuel will flow out. If more than 1 drop flows out in 5 seconds, recondition system pressure regulator or pressure compensating valve (07.3–210).

**Note:** An additional leak may show up at fuel reservoir or cold start valve.

For leak test of fuel reservoir, disconnect leak line between fuel reservoir and suction damper. Then loosen leak line on suction damper and pull off. Loosen clamp, a pressureless leak quantity is permitted. Renew fuel reservoir, if required (07.3–210).

Remove cold start valve (98) for leak test (07.3–125 section "Checking for leaks").

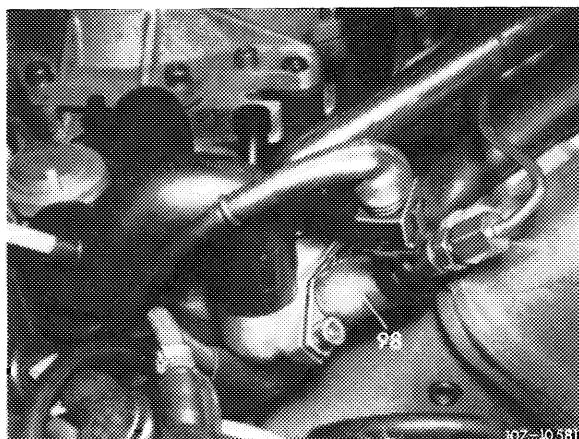

20 Disconnect pressure measuring device while catching fuel with a rag.

21 Connect fuel lines, run engine once again and check all fuel connections for leaks.