

05-440 Removal and installation of guide sprocket

Tightening torque

Nm

Bolt on crankcase front

270-330

Special tools

Torque wrench single arm, 3/4" square,
150-500 Nm

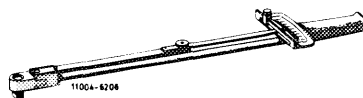

001 589 31 21 00

Socket 27 mm, 1/2" square



001 589 65 09 00

Detent
(starter flange left or right)

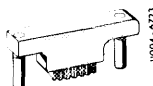

116 589 01 40 00

Allen wrench 6 mm

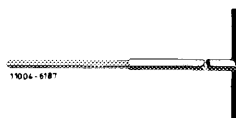

116 589 03 07 00

Insertion bushing for radial
sealing ring front

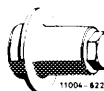

110 589 07 61 00

Conventional tool

Connection 3/4" square socket
to 1/2" square head

e.g. Hazet, D-5630 Remscheid
order No. 1058 RI

Removal

- 1 Remove timing housing cover (01-210).
- 2 Remove slide rail (87).
- 3 Slacken timing chain on intermediate sprocket (78) by turning on lefthand camshaft.
- 4 Remove intermediate sprocket (78).
- 5 Remove guide sprocket.

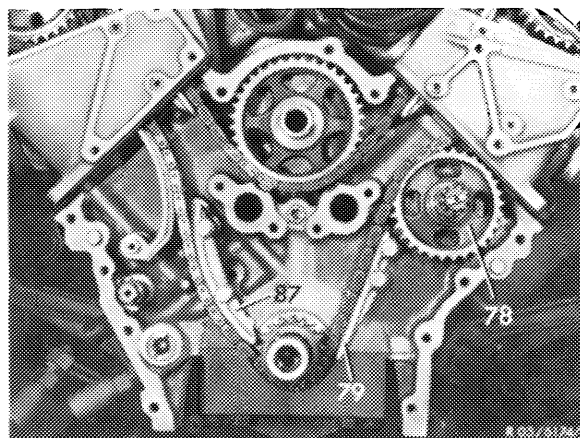

6 Pull off bearing bushing in cylinder crankcase by means of internal puller, if required.

7 Pull out guide bushing in timing housing cover by means of internal puller.

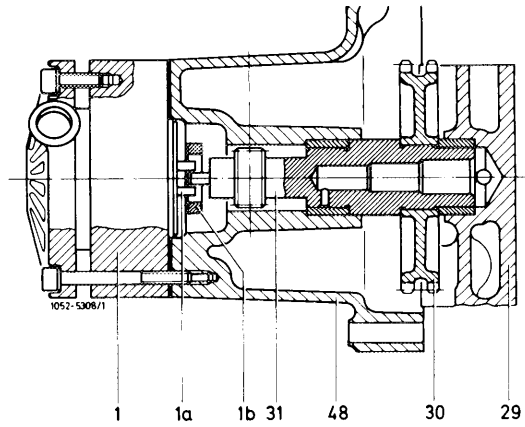

Installation

8 Press bearing bushing into cylinder crankcase and timing housing cover in such a manner that the lubrication groove is at bottom (arrow).

9 Provide bearing bushing in cylinder crankcase with oil and introduce guide sprocket.

10 Install intermediate sprocket (05-434).

11 For further installation proceed vice versa.

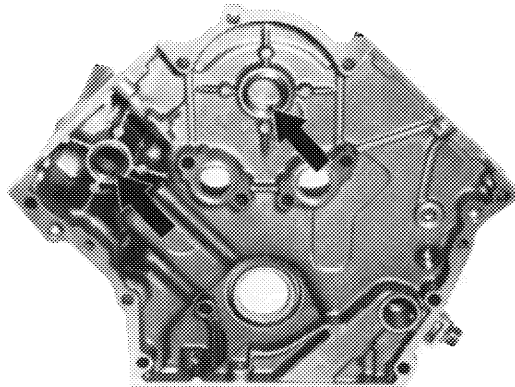

103-9559