

A. Standard version

**Test values**

System pressure at idle with engine cold or at operating temperature		5.0–5.6 bar gauge pressure
Control pressure at idle with engine at operating temperature	Warm-up compensator cycle completed	3.5–3.8 bar gauge pressure at 530 mbar <sup>1)</sup>
	Full load enrichment at idle speed (vacuum hose pulled off)	Engine 116 with warm-up compensator with Bosch end no.028 2.5–2.9 bar gauge pressure  Engine 116 and 117 with warm-up compensator with Bosch end no. 010 and 056 2.8–3.2 bar gauge pressure
Control pressure according to ambient teperature at idle speed with engine cold		min. 0.5 bar gauge pressure (refer to diagram)

<sup>1)</sup> If the control pressure is not attained, check intake pipe vacuum (refer to section "Checking control pressure at idle with engine at operating temperature").

**Special tool**

Pressure tester

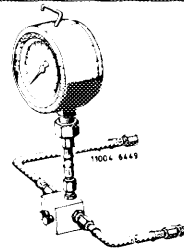

102 589 00 21 00

Clamp for hose lines



000 589 40 37 00

**Conventional tools**

Voltmeter, ohmmeter

Screwdriver element 992–T 30

e.g. Hazet, D–5630 Remscheid

## Note

---

Prior to working on injection system, check firing point, spark plugs and idle speed adjustment.

Perform leak test only in the event of complaints about hot starting.

After stopping the engine, the fuel pressure after 30 minutes should still amount to 2.5 bar gauge pressure.

## Visual checkup

---

1 Remove air filter.

2 Check all fuel connections for leaks.

3 Check adjusting lever (1) in air flow sensor and control piston (2) in fuel distributor for easy operation. For this purpose, pull plug from safety switch (3). Switch on ignition for a short moment to establish control pressure. Push air flow sensor plate (4) manually downwards. A uniform resistance should be felt along entire path. When moving up fast, no resistance should be felt, since the slowly following control piston lifts off from adjusting lever. During the slow upward movement, the control piston should smoothly follow.

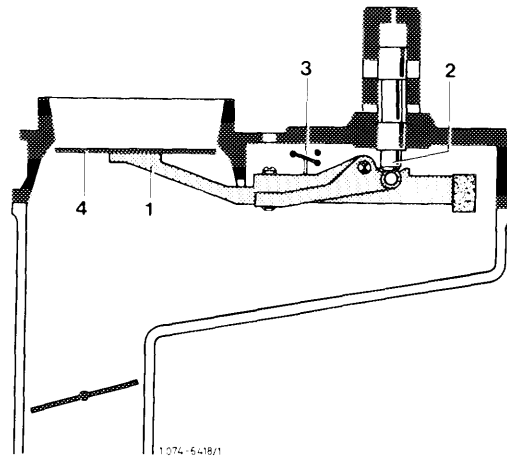

4 Check control piston in fuel distributor visually for leaks.

Push air flow sensor plate for a short moment down and hold in this position, during which no fuel should be seen in air guide housing.

If fuel emerges, renew fuel distributor (07.3–205).

## Connecting pressure measuring device

---

The pressure measuring device remains connected for all pressure measurements.

The pressure measuring device can be connected to warm-up compensator or to fuel distributor.

The pressure measuring device 102 589 00 21 00 is now provided with only one valve screw on three-way valve.

To relieve sealing rings, keep valve screw or valve screws always opened. Connections of three-way valve are numbered.

### Pressure measuring device 1st version

- Connection 1 = Hose line on fuel distributor
- Connection 2 = Hose line on pressure gauge
- Connection 3 = Hose line on released control pressure line

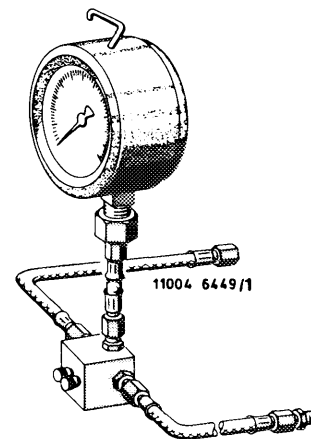

### Pressure measuring device 2nd version

- Connection A = Hose line on fuel distributor
- Connection B = Hose line on released control pressure line

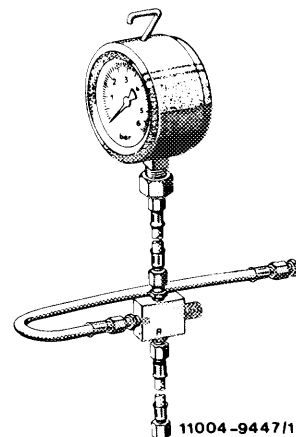

a) Connect pressure measuring device to warm-up compensator (air cleaner mounted).

Unscrew control pressure line (arrow) from warm-up compensator, while catching fuel with a rag.

Connect hose line with double-thread connection from connection "1 or A" to control pressure line. Screw connecting line from connection "3 or B" to warm-up compensator.

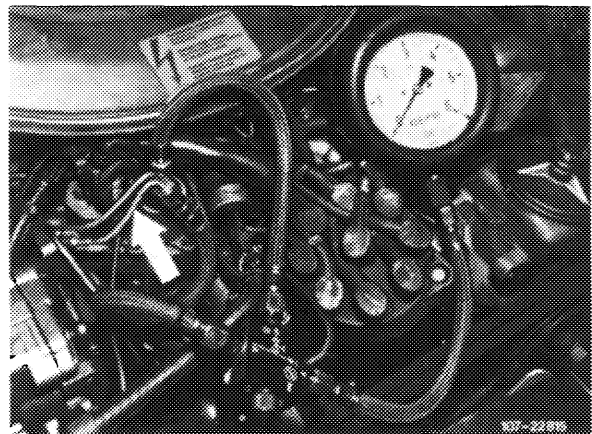

b) Connect pressure measuring device to fuel distributor (air cleaner removed).

Unscrew control pressure line (arrow) from fuel distributor, while catching fuel with a rag.

Connect hose line from connection "1 or A" to fuel distributor and connect hose line from connection "3 or B" to control pressure line (arrow).

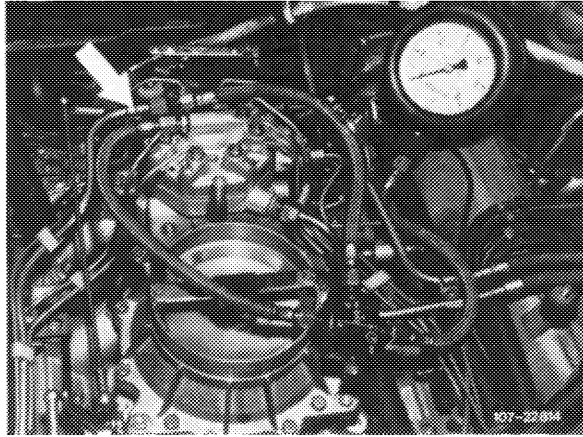

### Checking control pressure at idle with engine cold

- 1 Open valve screw or valve screws on pressure measuring device.
- 2 Run engine at idle and immediately read control pressure.

The nominal pressure is taken from control pressure diagram in accordance with ambient temperature. If the nominal value is not attained, recondition system pressure regulator (07.3—210) or check input screen in warm-up compensator. Renew warm-up compensator, if required.

#### Example engine 117:

Warm-up compensator with Bosch end No. 010  
 Ambient temperature + 20 °C = 1.1–1.5 bar gauge pressure.  
 Breakaway time at + 20 °C 3–6 minutes.

**Note:** Check breakaway time of warm-up compensator. All additional electrical consumers switched off and a minimum voltage of 12 volts. Read initial control pressure at + 20 °C. Breakaway time should be at 3.4 bar gauge pressure within tolerance.

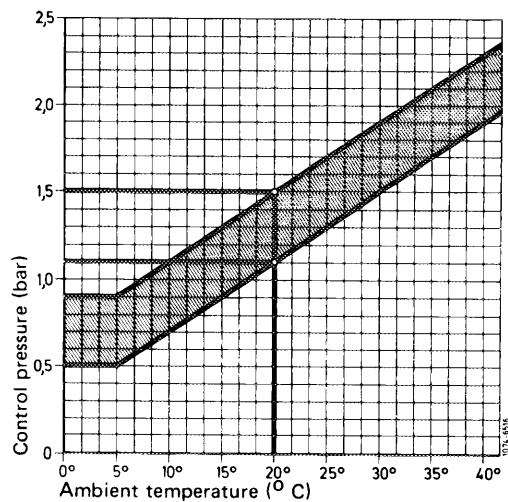

#### Example engine 116, 117:

Warm-up compensator with Bosch end No. 028 and 056  
 Ambient temperature + 20 °C = 1.2–1.6 bar gauge pressure.

Breakaway time at + 20 °C:

Warm-up compensator with Bosch end No. 028 = 3–6 minutes.

Warm-up compensator with Bosch end No. 056 = 2–4 minutes.

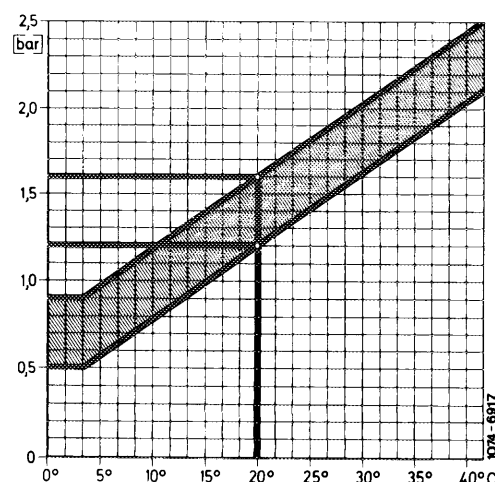

### Checking system pressure at idle with engine cold or at operating temperature

---

- 3 Close valve screw on pressure measuring device. On pressure measuring device with 2 valve screws, close valve screw on connection 3.
- 4 The system pressure should be 5.0–5.6 bar gauge pressure.
- 5 If the system pressure of 5.0–5.6 bar gauge pressure is not attained, check up as follows:
  - a) Check delivery of fuel pump (07.3–130).
  - b) Recondition system pressure governor (07.3–210).
  - c) Check fuel return line for unobstructed passage.
- 6 Open valve screw again.

### Checking control pressure at idle with engine at operating temperature

---

- 7 Open both valve screws or valve screw at pressure measuring device.
- 8 Control pressure should rise to 3.4–3.8 bar gauge pressure (warm-up compensator cycle completed).

If the control pressure of 3.4–3.8 bar gauge pressure is not attained, check up as follows:

- a) Check intake pipe vacuum. For this purpose, pull vacuum hose from warm-up compensator and fit a T-piece for pressure gauge.

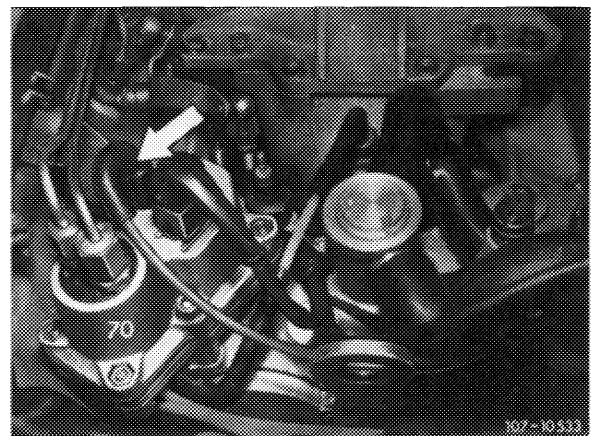

Read intake pipe vacuum and transfer to vacuum diagram.

**Example:**

Intake pipe vacuum 400 mbar = 3.5–3.9 bar gauge pressure.

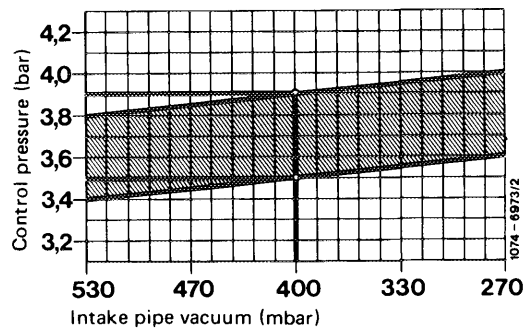

- b) Check voltage on warm-up compensator with engine running. Pull electrical connection from warm-up compensator and check voltage. Minimum voltage 12 volts (without electrical consumers).
- c) Check heater coil with an ohmmeter. If interrupted, renew warm-up compensator.

- 1 Fuel pump relay
- 2 Safety switch air flow sensor plate
- 3 Warm-up compensator
- 4 Fuel pump
- a Terminal 50 (starting)
- b Terminal 15/54 (ignition)
- c Plug connection 14-point Tail lamp harness

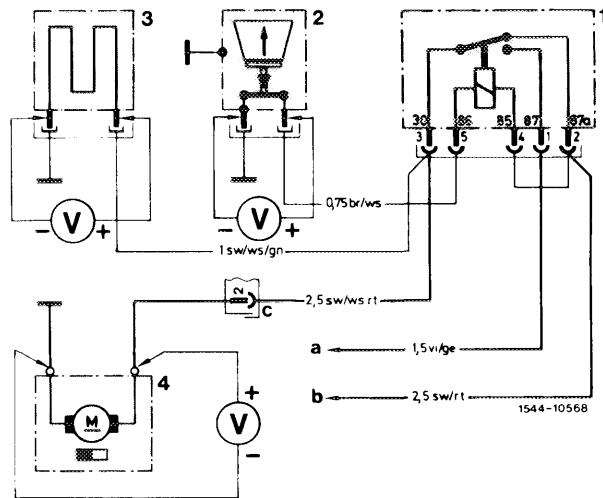

- d) If control pressure is above 3.8 bar gauge pressure, recondition system pressure regulator (07.3–210).

9 Check full load enrichment. For this purpose, pull vacuum hose from warm-up compensator, control pressure should then drop to 2.8–3.2 bar gauge pressure.

If the control pressure of 2.8–3.2 bar gauge pressure is not attained, replace warm-up compensator.

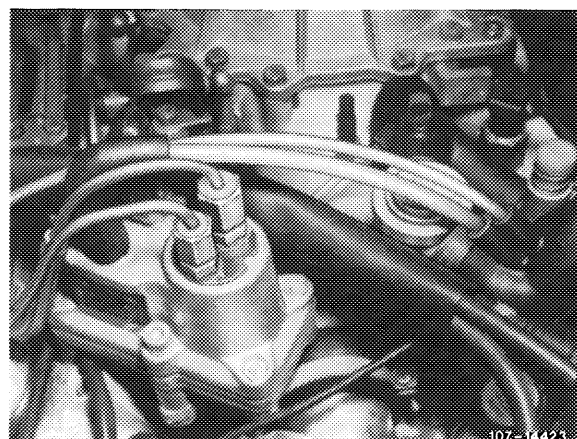

## Checking fuel distributor and fuel pump for leaks

---

10 Shut off engine. The control pressure will drop below opening pressure of injection valves (approx. 2.8 bar gauge pressure).

11 If the control pressure drops immediately to 0 bar gauge pressure, renew check valve on fuel pump or subsequently install.

12 If the pressure drops slowly, unscrew fuel return line on fuel distributor. With a leak on control piston or pressure compensation valve, fuel will emerge. If there is more than 1 drop in 5 seconds, recondition system pressure regulator or pressure compensating valve (07.3–210).

**Note:** There may also be a leak on fuel reservoir or cold starting valve.

To check for leaks on fuel reservoir, pinch the leak line between the fuel reservoir and the intake damper. Then loosen leak line on intake damper and pull off. Loosen clamp, a pressureless amount of leaking fuel is allowed. Renew fuel reservoir, if required (07.3–270).

Remove cold starting valve (98) for leak test (07.3–125 section "Checking for leaks").

13 Disconnect pressure measuring device, while catching fuel with a rag.

14 Connect fuel lines, run engine once again and check all fuel connections for leaks.

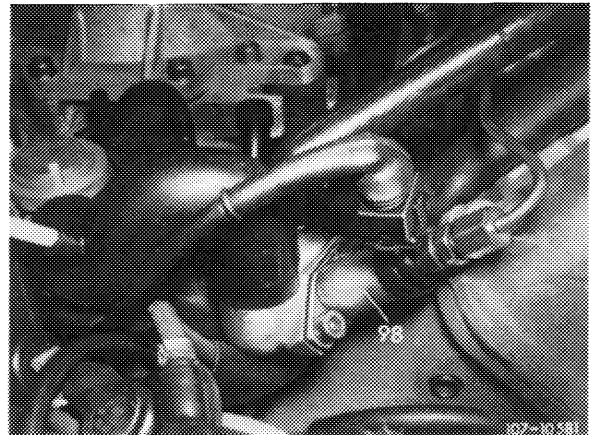

B. National version (AUS) (J) (S) (USA)

**Fuel pressures in bar gauge pressure engine 117**

Warm-up compensator Bosch end No. model year	System pressure at idle with engine cold or at operating temperature	Control pressure at idle with engine at operating temperature		
		Warm-up compensator stabilized at 530 mbar intake manifold vacuum <sup>1)</sup>	Full load enrichment at idle (vacuum hose pulled off)	Acceleration enrichment with engine stopped and 0.5 bar vacuum at warm-up compensator

(AUS) starting 1977

Information plate: color code silver

(J) starting 1976

Information plate: in Japanese language

(S) starting 1976

Information plate: color code blue

015 starting 1976	5.0–5.6	3.4–3.8	3.0–3.4	—
-------------------	---------	---------	---------	---

(USA) 1976–1980

Information plate: color code black Federal 1976–1980  
 green California 1976  
 yellow California 1977–1979  
 red Federal high altitudes 1977

015 1976–1978	5.0–5.6	3.4–3.8	3.0–3.4	—	
061 1979		3.6–4.0	3.2–3.6		
043 Federal only High altitudes 1977		3.4–3.8	—		1.4–1.8
068 1980					

<sup>1)</sup> On warm engine the control pressure values depend on intake manifold vacuum, on cold engine on ambient temperature. For this reason, in the event of deviations from nominal value, check intake manifold vacuum or ambient temperature and transfer to respective diagrams.

Transfer control pressure at idle on cold engine according to ambient temperature on diagram.



## Special tools

---

Pressure measuring device

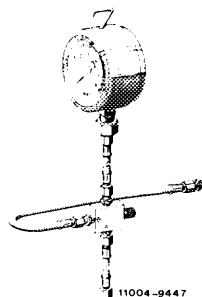

102 589 00 21 00

---

Clamp for hose lines

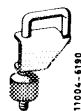

000 589 40 37 00

---

## Conventional tools

---

Voltmeter, ohmmeter

---

Screwdriver element 992-T 30

e.g. Hazet, D-5630 Remscheid

---

Vacuum pump

e.g. Mityvac

---

## Self-made tool

---

Contact bridge

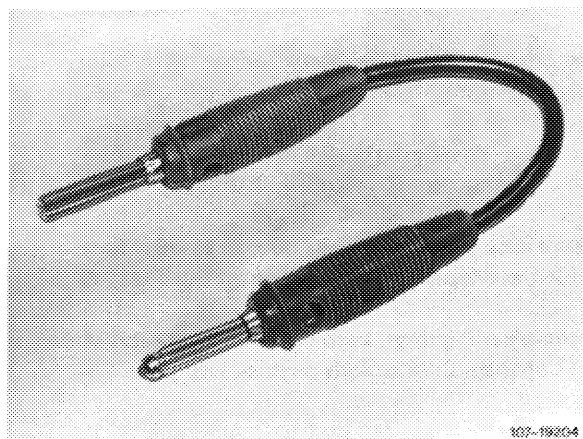

## Note

---

Perform leak test only in the event of complaints about hot starting.

After stopping engine, the fuel pressure should amount to 2.5 bar gauge pressure after 30 minutes.

## Visual checkup

---

- 1 Remove air cleaner.
- 2 Check all fuel connections on fuel distributor for leaks.
- 3 Check adjusting lever (1) in air flow sensor and control piston (2) in fuel distributor for easy operation. For this purpose, pull plug from safety switch (3). Switch on ignition for a short moment to establish control pressure. Push flow rate sensor plate (4) manually downwards. A uniform resistance should be felt along entire path. When moving up fast, no resistance should be felt, since the slowly following control piston lifts off from adjusting lever. During the slow upward movement, the control piston should smoothly follow.
- 4 Check control piston in fuel distributor visually for leaks.

Push flow rate sensor plate for a short moment completely down and hold in this position, no fuel should show up in air guide housing.

If fuel emerges, renew fuel distributor (07.3–205).

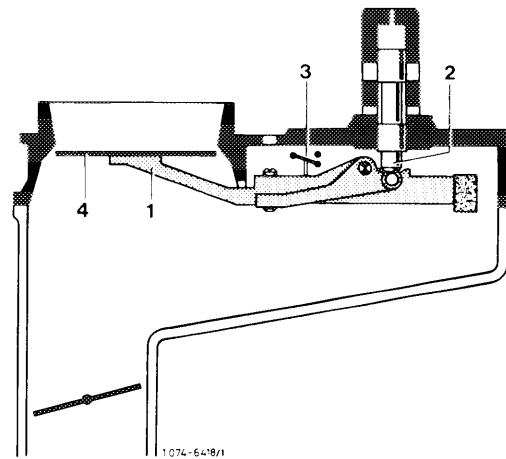

## Connecting pressure measuring device

---

Leave pressure measuring device connected for all pressure measurements.

The pressure measuring device can be connected to warm-up compensator or to fuel distributor.

Pressure measuring device 102 589 00 21 00 is now provided with only one valve screw on three-way valve.

To relieve sealing rings, keep valve screw or valve screws always opened. Connections of three-way valve are numbered.

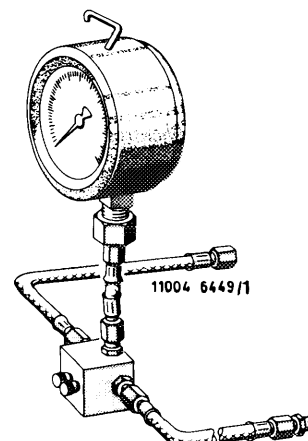

Pressure measuring device 1st version  
Connection 1 = Hose line on fuel distributor  
Connection 2 = Hose line on pressure gauge  
Connection 3 = Hose line on released control pressure line

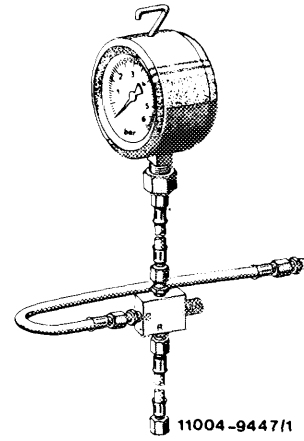

Pressure measuring device 2nd version  
 Connection A = Hose line on fuel distributor  
 Connection B = Hose line on released control pressure line

a) Connect pressure measuring device to warm-up compensator (air cleaner mounted).

Unscrew control pressure line (arrow) on warm-up compensator, while catching fuel with a rag.

Connect hose line with double-thread connection of connection "1 or A" to control pressure line. Screw connecting line of connection "3 or B" to warm-up compensator.

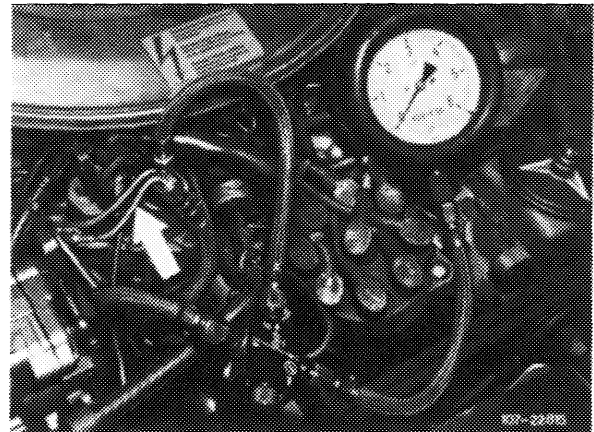

b) Connect pressure measuring device to fuel distributor (air cleaner removed).

Unscrew control pressure line (arrow) on fuel distributor, while catching fuel with a rag.

Connect hose line of connection "1 or A" to fuel distributor and connect hose line of connection "3 or B" to control pressure line (arrow).

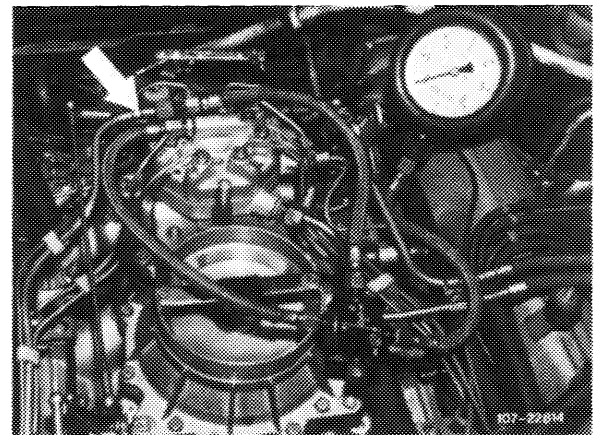

### Checking control pressure at idle on cold engine

- 1 Open valve screws or valve screw on pressure measuring device.
- 2 Run engine at idle and immediately read control pressure.

Take nominal pressure according to ambient temperature from control pressure diagram. If the nominal value is not attained, recondition system pressure regulator (07.3-210), or check input screen in warm-up compensator. Renew warm-up compensator, if required.

(AUS) (J) (S) 1976–1980  
 (USA) 1976–1978

Warm-up compensator Bosch end No. 015.

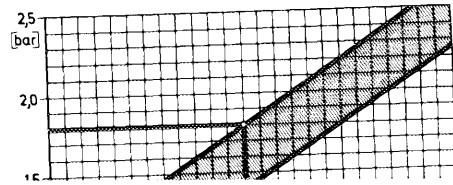

(USA) Federal higher altitudes 1977

**Example:**

Intake pipe vacuum 400 mbar = control pressure  
3.7–4.1 bar gauge pressure

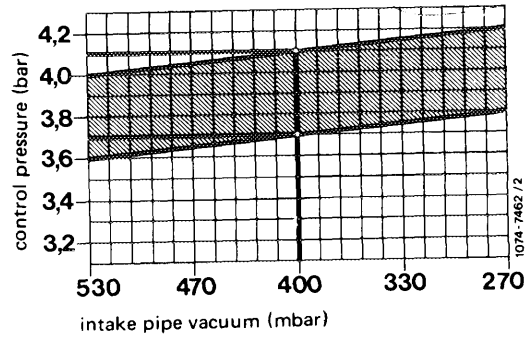

- b) Check voltage on warm-up compensator with engine running. Pull electrical connection from warm-up compensator and check for voltage. Minimum voltage 12 Volts (without consumers).
  - c) Check heater winding with an ohmmeter.
- If interrupted, replace warm-up governor.

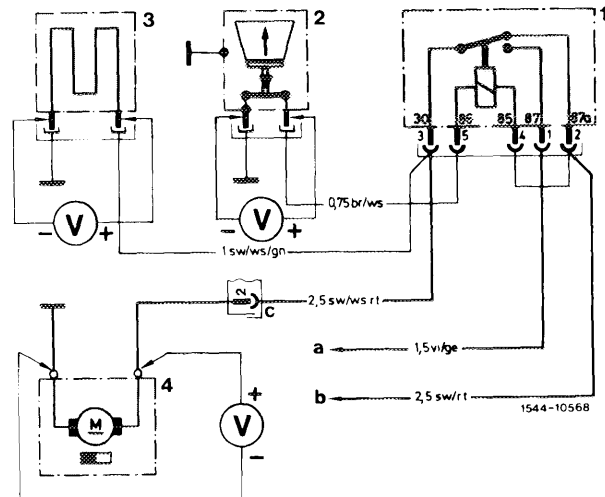

- 1 Fuel pump relay
- 2 Safety switch air flow sensor plate
- 3 Warm-up compensator
- 4 Fuel pump
- a Terminal 50 (starting)
- b Terminal 15/54 (ignition)
- c Plug connection 14-point Tail lamp harness

d) If control pressure is above nominal value, recondition system pressure regulator (07.3–210).

9 Check full load enrichment. For this purpose, pull vacuum hose from warm-up compensator, control pressure should drop to specified value.

If the control pressure is not attained, replace warm-

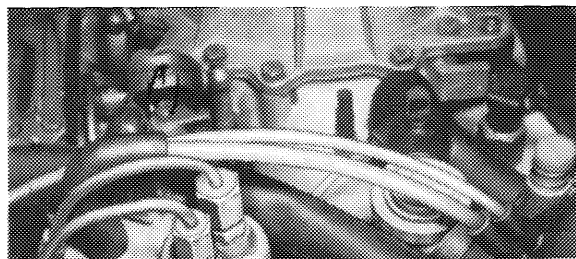

USA 1979

Connection (1) for full load enrichment has been placed on intermediate plate. Connection (2) is for venting. For this reason, pull vacuum hose from connection (1) for checking full load enrichment.

If full load enrichment is not attained, renew warm-up compensator.

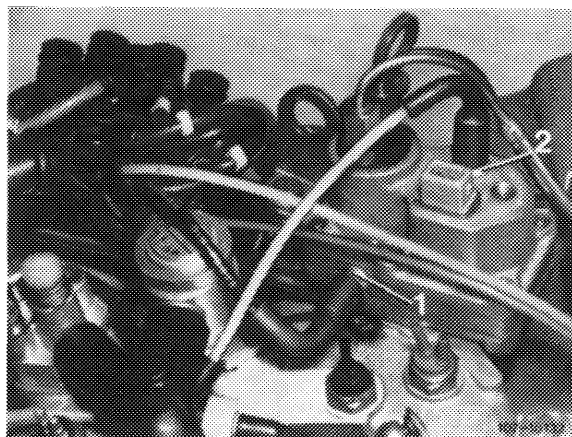

USA 1980

#### Checking acceleration enrichment

10 Check thermostatic valve (37) for passage. For this purpose, pull off vacuum hose (arrow), thermostatic valve is closed below approx. 50 °C, passage must be available above approx. 50 °C coolant temperature. If not, renew thermostatic valve (37).

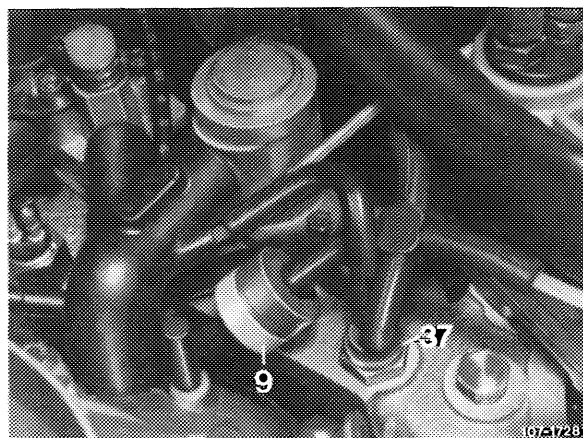

11 Run engine until warm-up compensator is stabilized (3.4–3.8 bar gauge pressure).

12 Stop engine, pull off fuel pump relay (arrow).

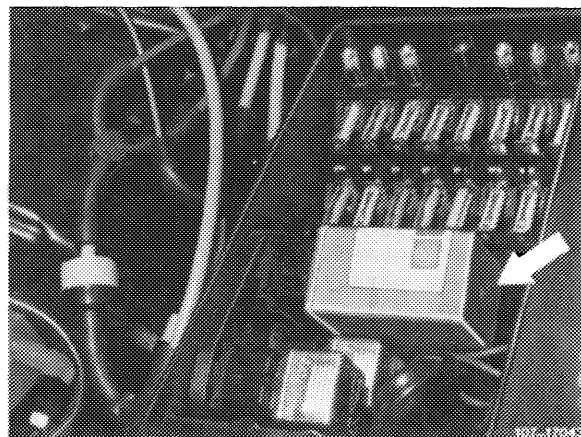

13 Pull vacuum line of vacuum chamber from warm-up compensator (2).

14 Plug vacuum pump on contour hose (arrow) and energize warm-up compensator with 0.5 bar vacuum.

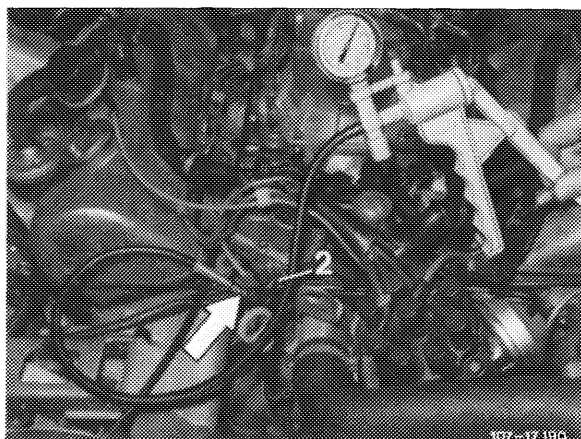

15 Bridge jacks 1 and 2 (arrow).

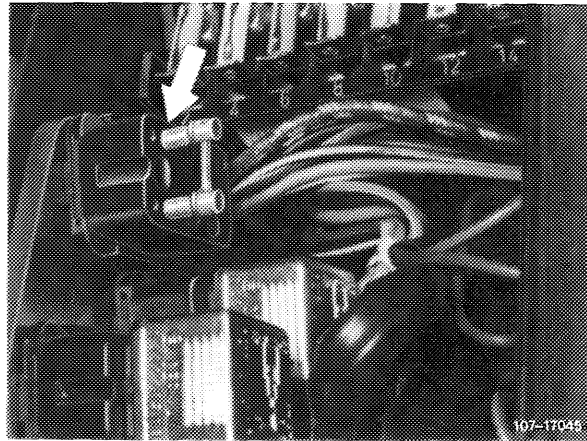

16 Control pressure should then amount to 1.4–1.8 bar gauge pressure. If control pressure deviates from nominal value, renew warm-up compensator.

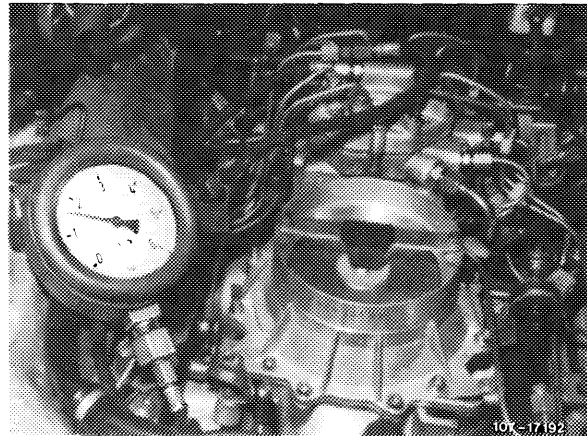

### Checking fuel distributor and fuel pump for leaks

---

17 Stop engine. Control pressure will then drop below opening pressure of injection valves (approx. 2.8 bar gauge pressure).

18 If the control pressure drops immediately to 0 bar gauge pressure, renew check valve on fuel pump or subsequently install.

19 If the pressure drops slowly, unscrew fuel return line on fuel distributor. Fuel will emerge with a leak on control piston or pressure compensating valve. If there is more than 1 drop in 5 seconds, recondition system pressure regulator or pressure compensating valve (07.3–210).

**Note:** Another leak may be located on fuel reservoir or cold starting valve.

To check fuel reservoir for leaks, pinch leak line between fuel reservoir and intake damper. Then loosen leak line on intake damper and pull off. Loosen clamp, a pressureless quantity of leaking fuel is allowed. Renew fuel reservoir, if required (07.3–270).

Remove cold starting valve (98) for leak test (07.3–125 section “Checking for leaks”).

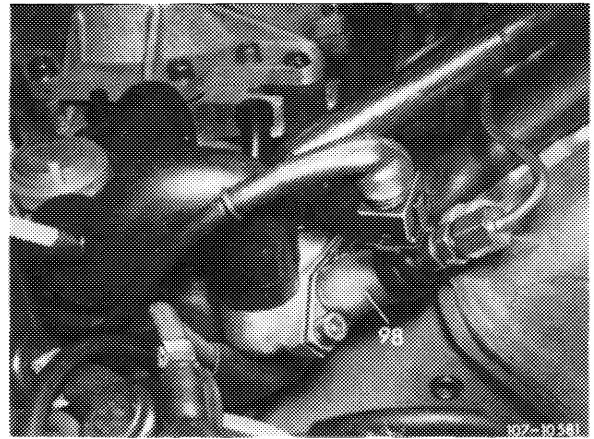

20 Disconnect pressure measuring device, while catching fuel with a rag.

21 Connect fuel lines, run engine once again and check all fuel connections for leaks.