

Headlights, lamps and signalling system

Note

To check external lights, a mirror may be used instead of a second person.

- Actuate rotary light switches to check the following functions:

Parking light left and right

Standing/tail/instrument lights

Low beam

High beam and high beam indicating light

Fog light/rear fog lamp and indicator light

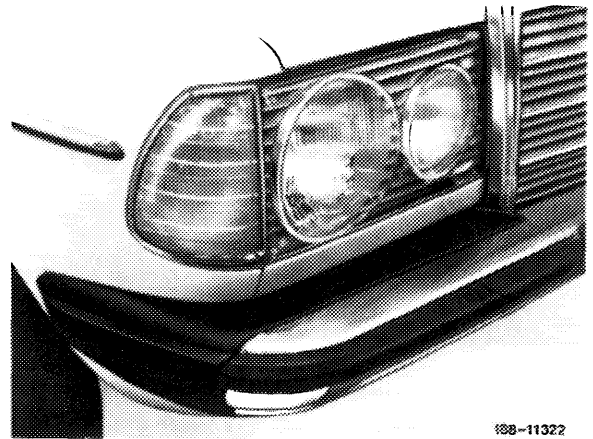

12B-11322

Ignition switched off

- Check function of:

Warning flasher system and indicating light.

Ignition switched on

Engine shut off, parking brake actuated.

- Check function of:

Warning lamp for parking brake und brake fluid level.

Warning lamp for lining wear indicator (warning lamp should light up at half its brightness when ignition is switched on).

Charge indicator light.

Turn signal left and right and indicator lights, head-light flasher,

brake light by actuating service brake, back-up light

by engaging reverse gear, horn by actuating horn ring.



R 82 / 6604

Window washer

- Clean nozzles with suitable needle.
- Check adjustment of nozzles. Types 100 to 116; when actuating windshield washer, water jet should impinge at approx. $\frac{2}{3}$ of pane height.

On model 123 the nozzle has two outlet holes. Adjust nozzles as shown in drawing (measurements in mm).

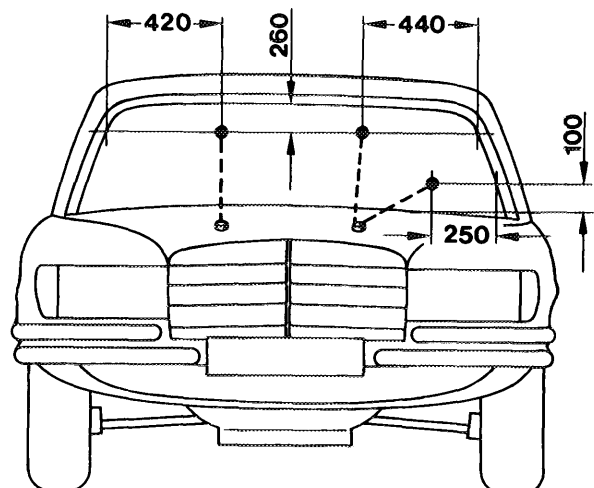

1824-7584

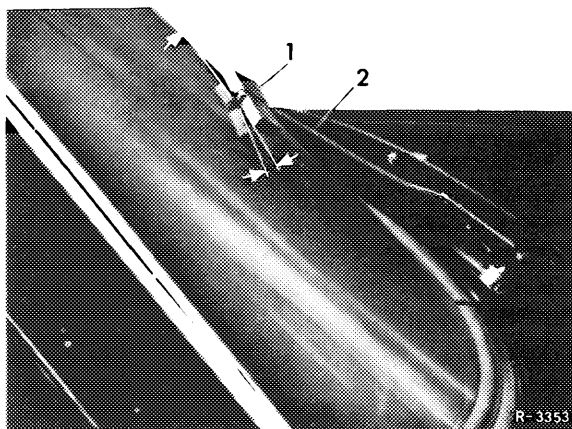

Correct wiper arm positioning

1 Wooden check gauge

2 Wiper arm

Windshield wiper

- Check rubber lips of wiper blades for hardening or cracks.
- Also ensure that the rubber lip of the wiper blade tilts over when the direction of movement changes. If necessary correct distortion of the wiper arm so that the end of the wiper arm lies parallel to the wiping area. This can be checked using an easily made wooden check gauge.

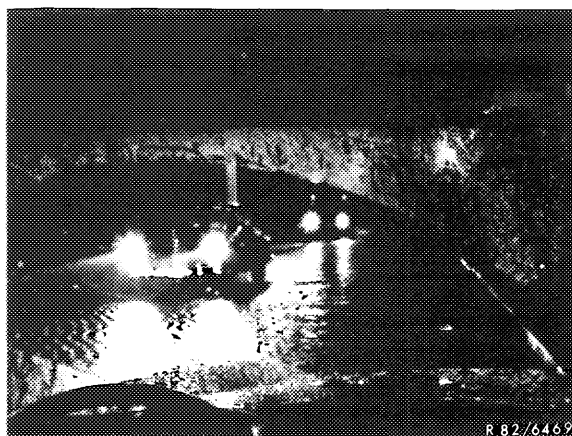

Wiping pattern with good wiper blades

- Operate windshield wipers and washer unit for a short period. The wiping area must be wiped clear.

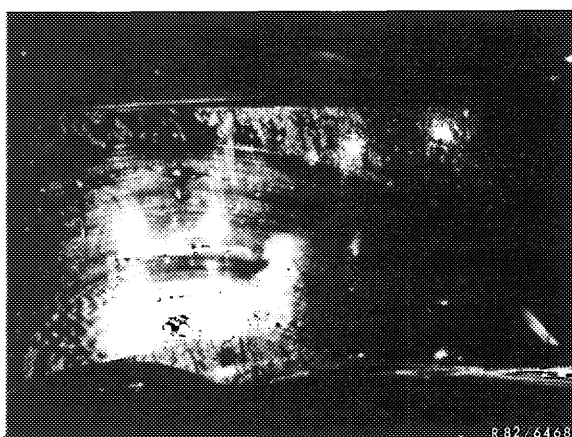

Wiping pattern with worn-out wiper blades or dirty windshield

Heating and ventilation

- Move air volume control lever or control lever for the ventilation to the "on" position, switch on blower and check through all stages (with the ignition switched on).
- Move control lever for heating or temperature selector knob in "heating" position; check lever for stiffness and heater unit for function.

Note: With stiff control levers or control valves of the heater unit, add 2 to 5 cc/ltr. of anti-corrosion oil into the coolant.

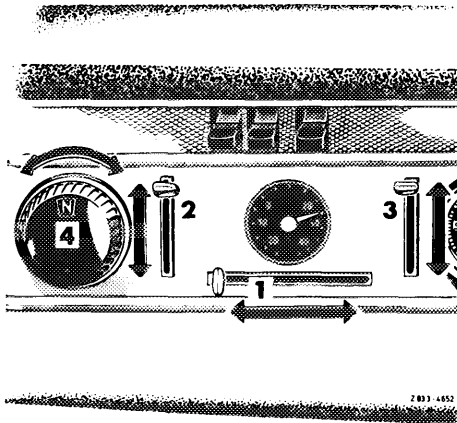

Model 100

- 1 Air volume control lever and blower switch
- 2, 3 Air distribution lever
- 4 Temperature selector knob

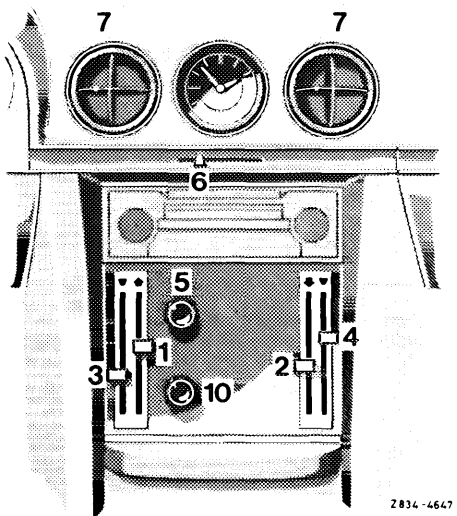

Model 107

- 1, 2 Air distribution lever
- 3, 4 Heater control lever
- 5 Blower switch
- 6 Control lever for ventilation

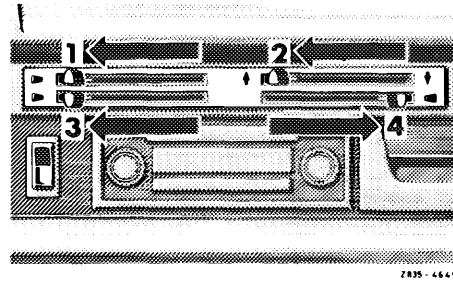

Models 108, 109, 111

- 1 Air volume control lever and blower switch
- 2 Air distribution lever
- 3, 4 Heater control lever

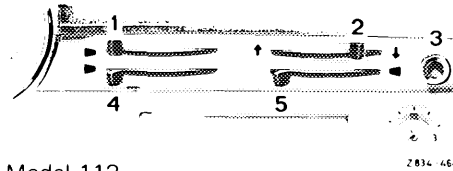

Model 113

- 1 Air volume control lever
- 2 Air distribution lever
- 3 Blower switch
- 4, 5 Heater control lever

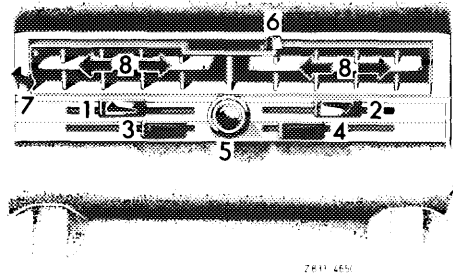

Models 114, 115

- 1, 2 Air distribution lever
- 3, 4 Heater control lever
- 5 Blower switch
- 6 Control lever for ventilation

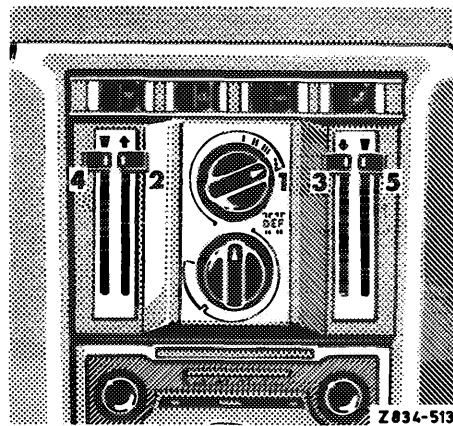

Model 116

- 1 Switch for air volume control and blower
- 2, 3 Air distribution lever
- 4, 5 Heater control lever

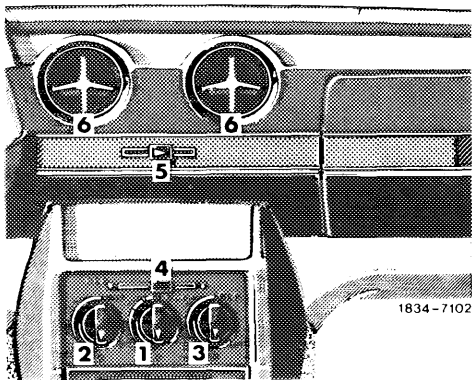

Models 123.023, 123.123

- 1 Air volume switch
- 2 3 Heater switch
- 4 Air distribution lever
- 5 Control lever for air intake

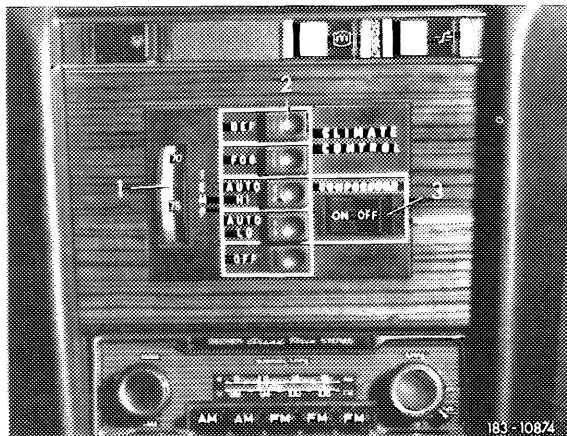

Model 116 Model year 1976

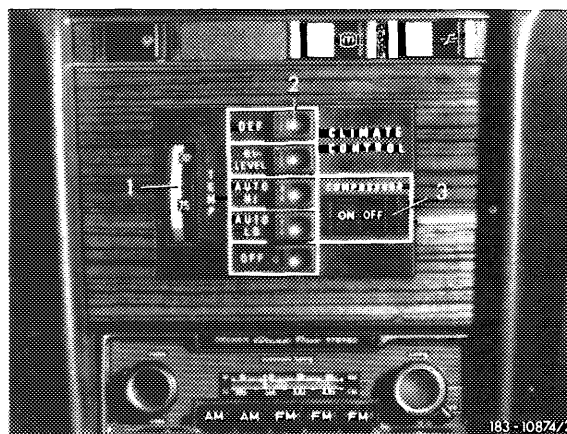

Model 116 Starting model year 1977

Automatic climate control

- Start engine and accelerate several times for short moments then stop engine.
(This will evacuate the vacuum system. Only required if the engine has been inoperative for an extended period.)
- Switch-on ignition, **but do not yet start engine.**
- Operate push button switch as follows.

Push button switch	Coolant temperature	
	below 40°C (104°F)	above 40°C (104°F)

	Blower	
"Auto-LO"	Off	Should start
"Auto-HI"	Off	Should start
"FOG" or "BI-LEVEL"	Should start	Should start
"DEF"	Should start,	highest blower stage
"OFF"	Should start ¹⁾	Off within 10 sec.

¹⁾ When coolant temperature exceeds 40°C (104°F) blower is shut off (temperature switch in regulator closed)

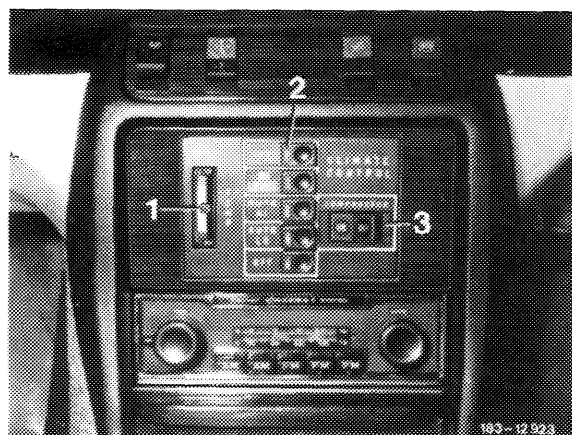

Model 123