

Engines 615 616 617
up to model year 1979

Test values

Idle speed	up to model year 1975		700–800/min (aural check)
	model year 1976	Engine 616 617	700–780/min 680–760/min
	model year 1977:78	Engine 616, 617, 912	700±50/min (aural check)
	model year 1979		750 min
	model year 1978:79	Engine 617, 950	750±100 min

- Run engine to 60–80 °C (104–176 °F) oil temperature.
- Turn idle speed adjustment knob on the instrument panel fully to the right.
- On injection pumps with pneumatic governor, disconnect regulating rod (3) and adjust idle speed by means of idle speed adjusting screw (4) on throttle unit by ear to rated engine speed.

Engines 615, 616 in model 115

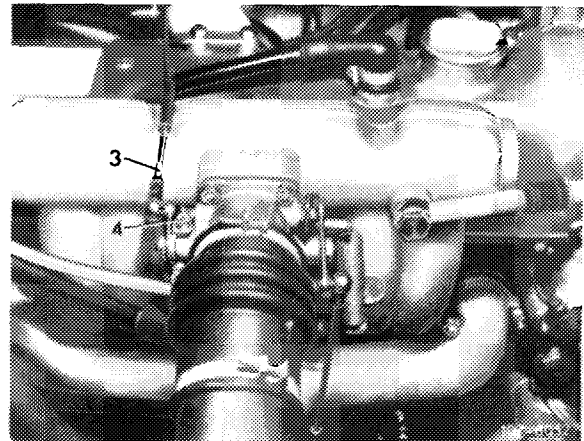

- On injection pumps with mechanical governor, disconnect regulating rod (2) and adjust idle speed by means of idle speed adjusting screw (4) after loosening counter nut (3) by ear to rated engine speed.

Engine 617 in model 115

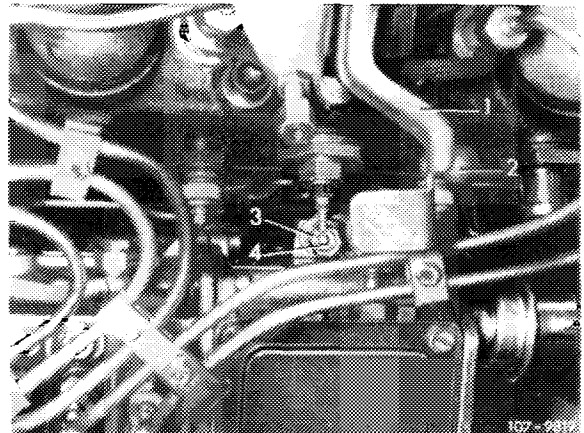

Engines 616, 617 in model 123

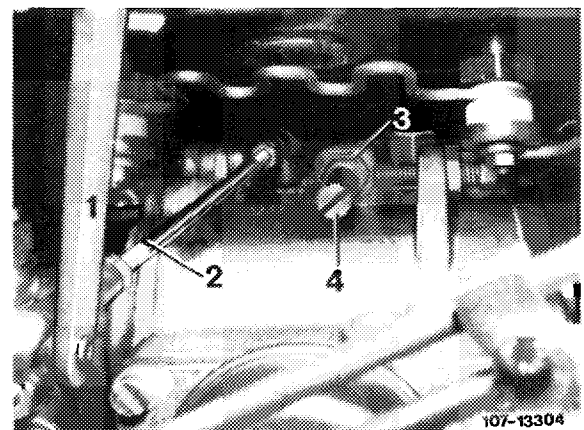

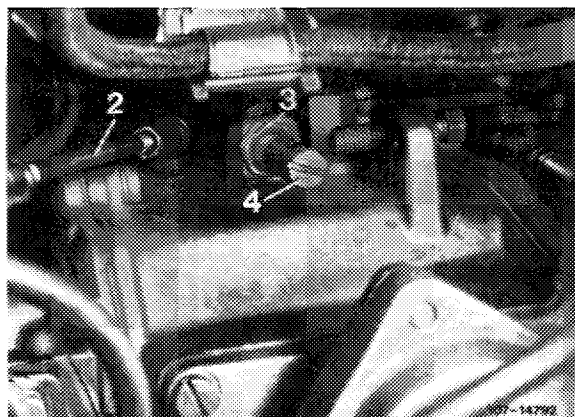

- On engine 617.950 adjust idle speed in accordance with the tachometer installed in the vehicle.

Engine 617.950 in model 116

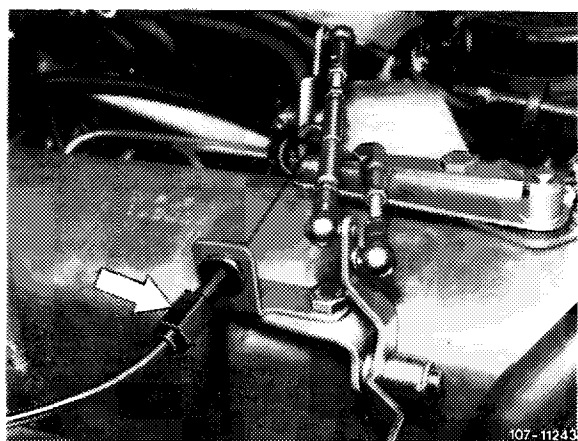

- Check Bowden wire for Tempomat (cruise control) and adjust, if required. For this purpose, push shutoff lever against stop. Bowden wire should rest free of tension against regulating lever. Adjust Bowden wire with adjusting nut (arrow or 1 resp.) if required. Release shutoff lever (idle speed position). In this position, Bowden wire is slack.

Model 115

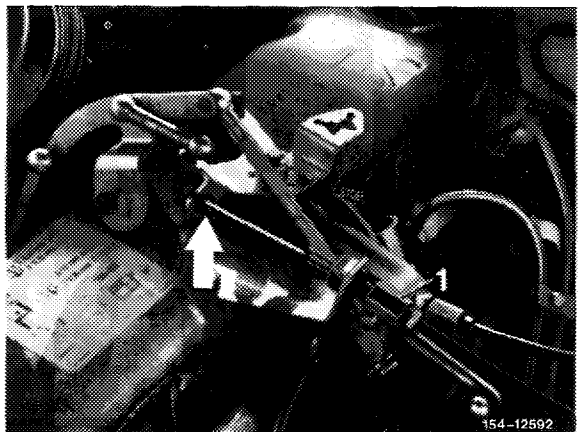

Model 123

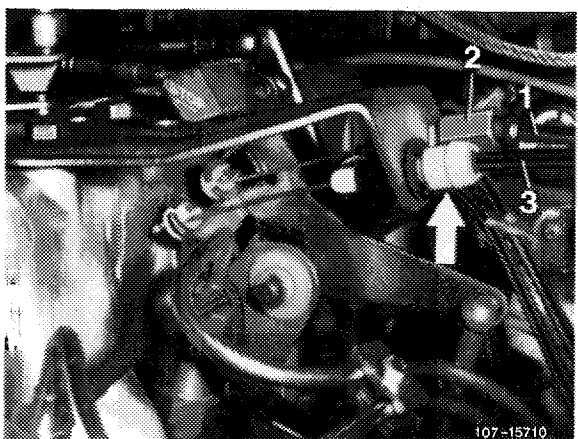

Model 116

Engine 616 617.912
 USA Model year 1980

Identification: Identification label in national language on cross member in front of radiator.

Engines should be adjusted in accordance with the data mentioned on the pertinent emission identification label.

Test values

Engine	Model year	Idle speed 1/min
616.912	1980	750 ± 50
617.912	1980	750 ± 50

Special tool

Oil telethermometer



116 589 27 21 00

- Connect oil telethermometer.
- Run engine to approx. 75–85 °C (170–185 °F) oil temperature.
- Turn knob or preglow starter switch for idle speed adjuster on instrument panel completely to the right.
- Disconnect push rod (41) on angle lever.
- Check idle speed, loosen counter-nut (3) if required and adjust idle speed to specified speed of 750±50/min by means of idle speed adjusting screw (4) by ear.

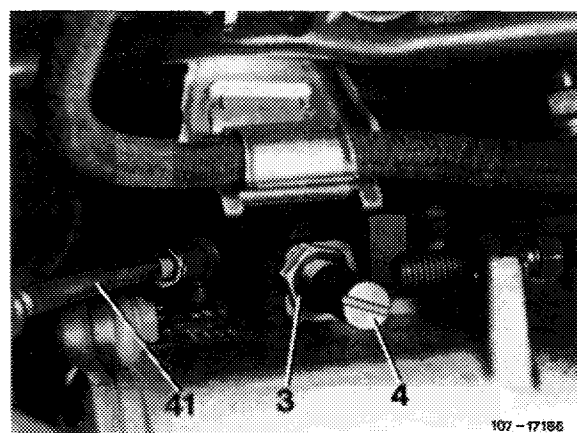

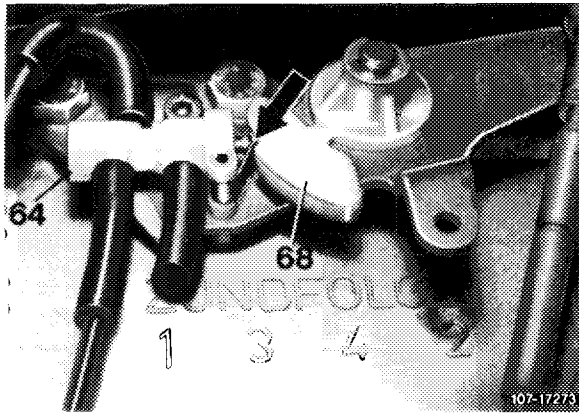

- Check adjustment of regulating linkage.

The push rod (41) should be set in such a manner that max. 0.5 mm clearance (refer to arrow) is available between control cam lobe of guide lever (68) and plate of switchover valve (64).

The regulating lever should rest against idle speed stop.

- Check Bowden wire for cruise control and adjust, if required. For this purpose, push shutoff lever up to stop. Bowden wire should rest free of tension against regulating lever. Adjust Bowden wire with adjusting screw, if required. Release shutoff lever (idle speed position). Required clearance for Bowden wire is available in this position.

- Move selector lever into driving position, engage automatic climate control, turn power steering to full lock, engine should run smoothly. Readjust speed, if required.

Attention! The idle speed control range will be abandoned when the speed is set higher. As a result, the engine speed may increase up to max. speed (no load).

Engine 617.950
 (USA) Model year 1980

Identification: Identification label in national language on cross member in front of radiator or on cylinder head cover.

Engines should be adjusted in accordance with the data mentioned on the pertinent emission identification label.

Test values

Engine	Model year	Idle speed 1/min
617.950	1980	750 ± 100

Special tool

Oil telethermometer



116 589 27 21 00

Conventional tool

Digital tester

e.g. made by Bosch, MOT 001.03

- Connect digital tester to socket (diagnosis) and oil telethermometer.
- Run engine up to approx. 75–85 °C (170–185 °F) oil temperature.

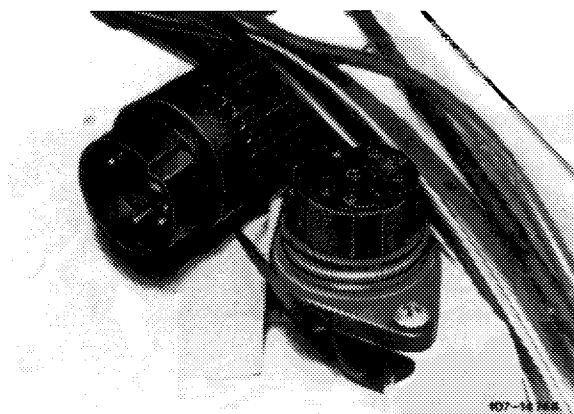

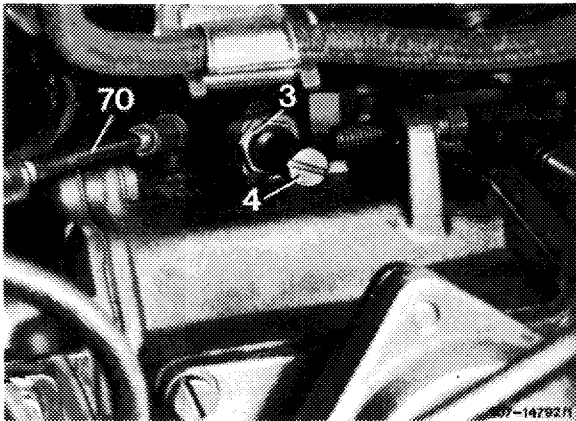

- Disconnect push rod (70) from angle lever.
- Check idle speed, loosen counter nut (3), if required, and set idle speed to 750 ± 100 /min by means of idle speed adjusting screw (4).

Note: The idle speed can also be set on revolution counter installed in vehicle.

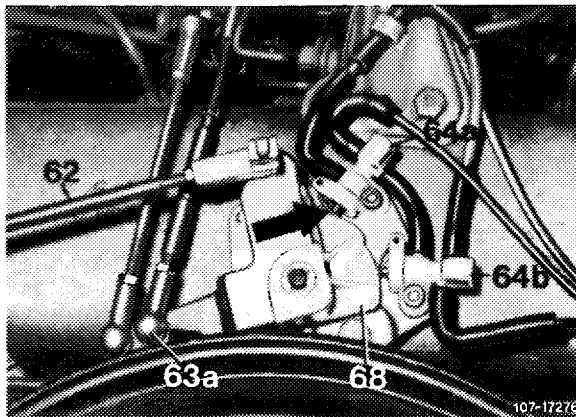

- Adjust push rod (70) in such a manner that max. 0.5 mm clearance is available between control cam lobe of guide lever (68) and plate of switchover valve (64) (refer to arrow). The regulating lever should rest against idle speed stop.

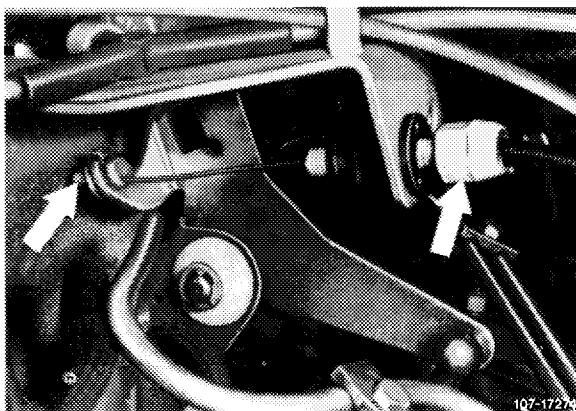

- Adjust Bowden wire for cruise control. For this purpose, push shutoff lever up to stop. Bowden wire should rest free of tension against regulating lever. Adjust Bowden wire with adjusting screw (arrow), if required. Release shutoff lever (idle speed position). This position provides the required clearance for Bowden wire (arrow at the left).

- Move selector lever into driving position, engage automatic climate control, turn power steering to full lock, engine should run smoothly. Readjust speed, if required.

Attention! The idle speed control range will be abandoned when the speed is set higher. As a result, the engine speed may increase up to max. speed (no load).

Check and adjust idle speed and idle CO

798

Revision: New model year added.

Engines 100.985 110.984/985 117.985/986
with CIS (continuous injection system)
starting model year 1976

Adjust engines according to data on pertinent emission control information plate.

Test values

Engine	Model year	Idle speed 1/min	Idle speed emission value % CO with or without air injection
--------	------------	------------------	--

Federal and California version

100.985	1977	600	without 0.2–2.0 Federal and California version 0.2–1.2 Federal high altitude version
	starting 1978		0.5–2.0 Federal and California version
110.984/985	1977/78	800	without 0.4–2.0
	starting 1979		0.4–2.0 Federal version without California version without
117.985/986	1976	700–800	without 0.2–1.5
	1977	750	California version without 0.2–2.0 Federal version with 0.2–2.0 Federal high altitude version with 0.2–1.2
			0.5–2.0 Federal version with California version without
starting 1978			

Special tools

Remote oil temperature gauge



116 589 27 21 00

Allen wrench for hex. socket screw
3 mm with tommy bar

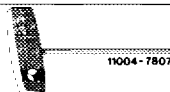

000 589 14 11 00

Conventional tools

Tachometer, CO measuring instrument



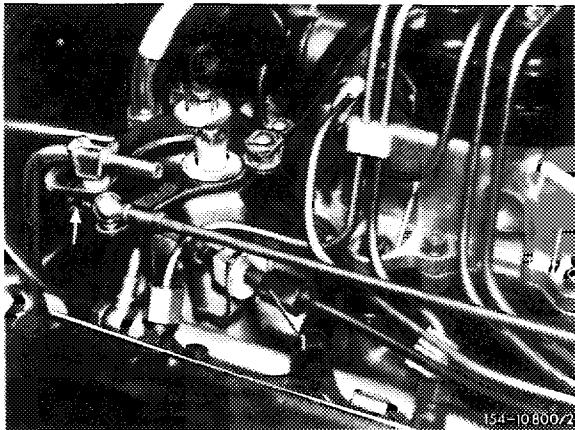

- Connect tachometer and CO measuring instrument (job no. 781).
- Disconnect air conditioner. Place selector lever into position "P".
- Check whether Bowden wire for cruise control rests free of tension against regulating lever. Adjust with adjusting nut, if required.
- Run engine up to 60–80 °C (104–176 °F) oil temperature.

Engines 100, 117



Engines 110

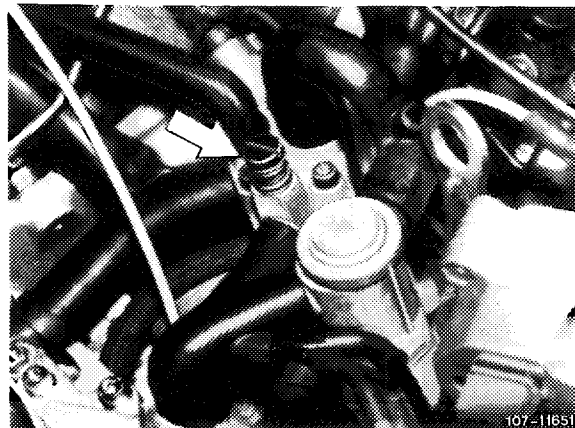

- Check whether throttle valve lever rests against idle speed stop.
- Idle speed, check and adjust to specified speed by means of idle speed – air screw (arrow or 10), if required.

Engines 100, 117

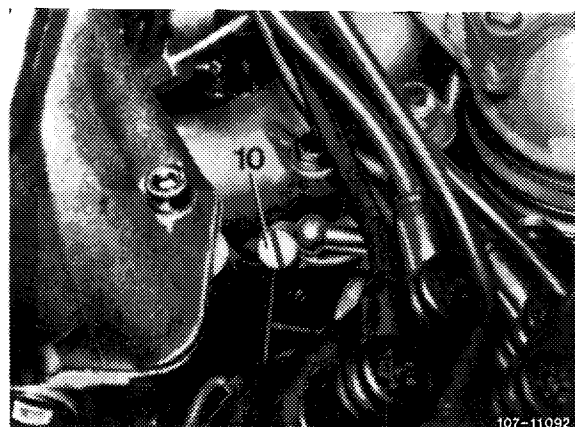

Engine 110

• **Check idle speed CO level**

Model year 1976

Check idle speed CO level **without air injection**. For this purpose disconnect blue/purple vacuum line (arrow) at blue thermo valve (61) and plug opening on thermo valve. This stops air injection.

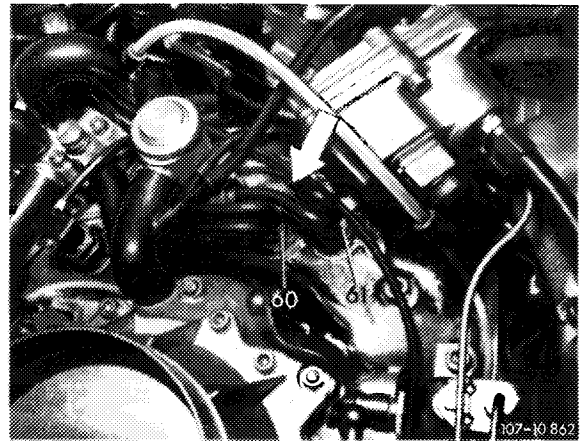

Starting model year 1977

Connect CO tester. For this purpose disconnect connecting hose (arrow) at measuring point (exhaust back-pressure line).

Connect CO tester and exhaust back-pressure line with a hose.

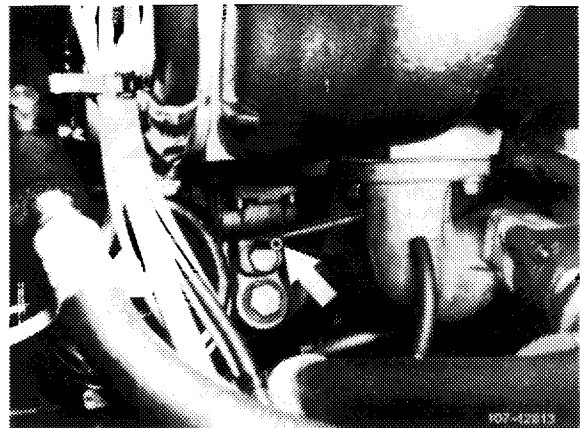

Engine 100

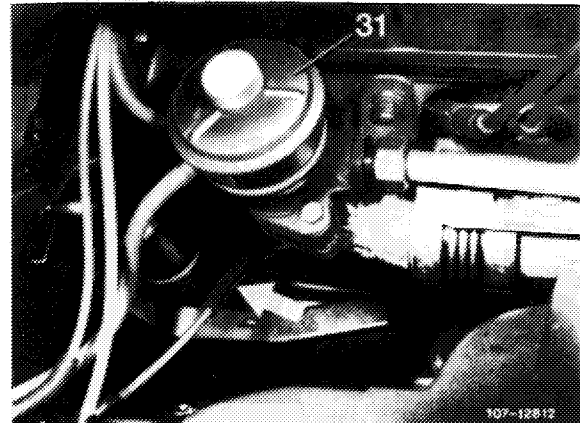

Engine 117

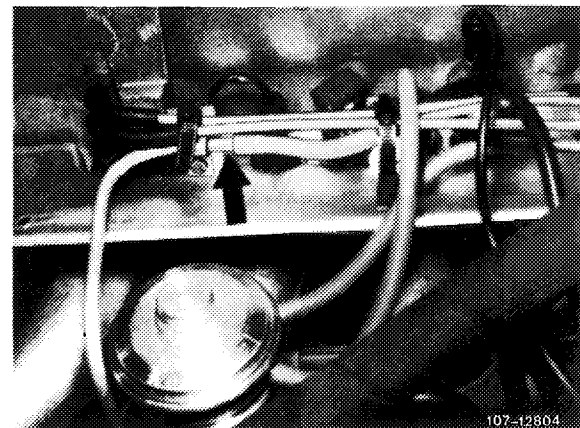

Engine 110

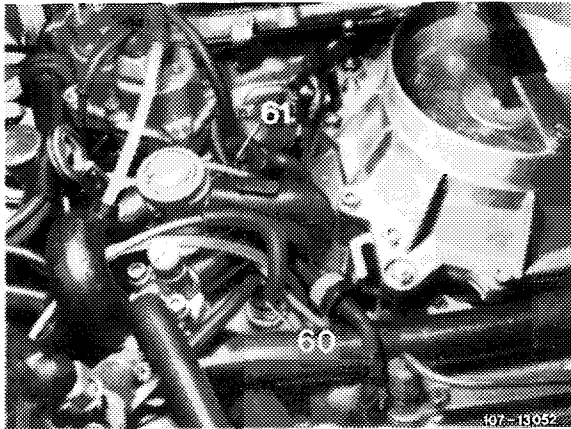
**Engines 100, 117**

Check **with** air injection for engine 117 federal version, **without** air injection for engines 100 and 117 California version. For this purpose disconnect blue/purple vacuum line at straight connection of blue thermo valve (60) and plug connection on thermo valve. This stops air injection.

Engine 100

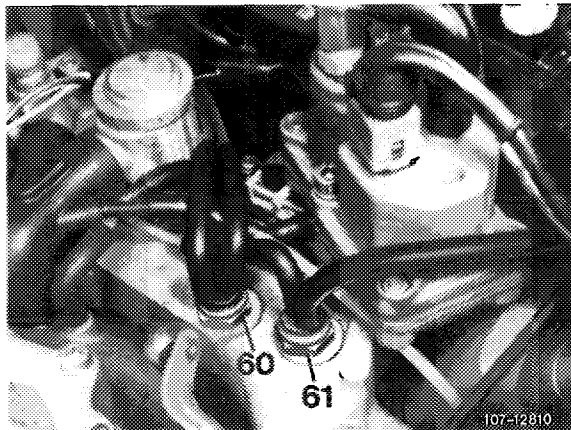

Engine 117

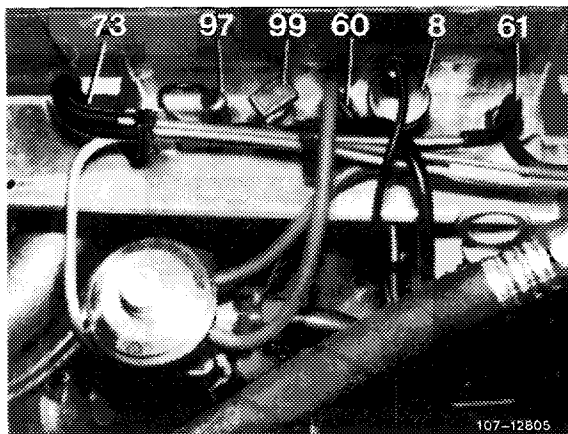
**Engine 110**

Check **without** air injection into cylinder head for engine 110. For this purpose disconnect blue vacuum line at blue thermo valve (60) and plug line. This stops air injection.

- Adjust idle speed emission value.
For this purpose, unscrew closing screw (arrow).

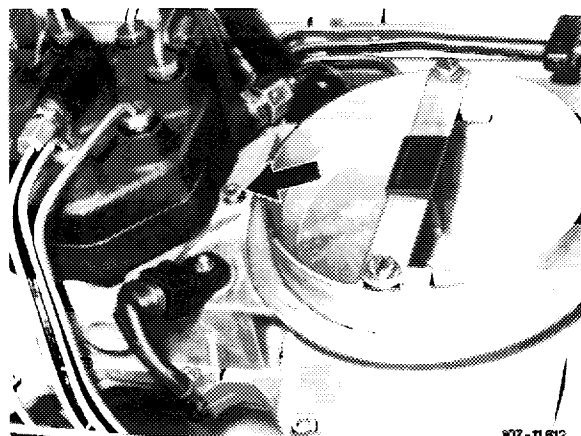

Insert Allen wrench through bore into idle speed mixture control screw (hex. socket screw) and adjust emission value by turning screw.

Screwing out = leaner
Screwing in = richer

After turning idle speed mixture control screw, close bore for closing screw.

Accelerate for a short moment, check speed and emission value once again and adjust, if required.

Engines 100, 117



Put back vacuum line on thermo-valve.

Check idle speed emission value once again (air injection operative). Idle speed emission value should be **below** previously adjusted value.

Engine 110

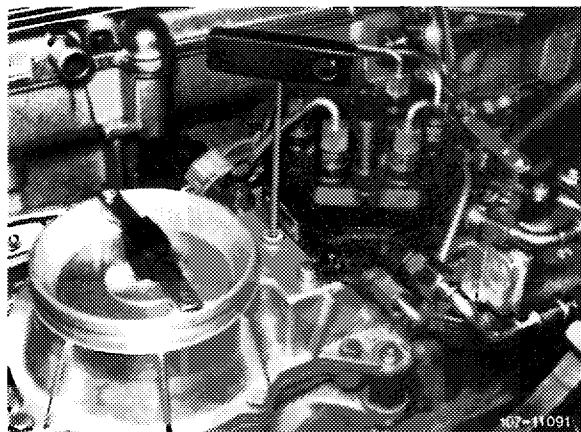

- **Adjust regulating linkage**

Adjust connecting rod (2) in such a manner that the roller (3) rests free of tension in gate lever (4).

Place selector lever into driving position. Switch on air conditioner. Turn power steering to full lock, with engine running smoothly. Adjust speed, if required.

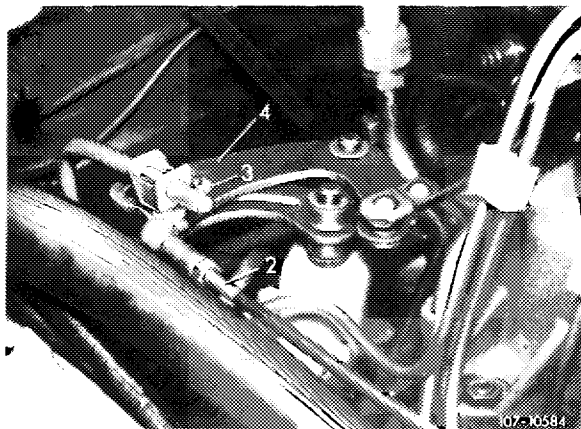

Engines 100 130
with mechanical injection system

Test values

All vehicles must be adjusted to the values shown on information plate for emission control system.

Engine	Idle speed 1/min Model year 1972	Idle speed emission value % CO Model year 1972
100.980/981	560–600	1.0–4.0
130.98	700–850	1.5–3.5

Special tool

Oil telethermometer



116 589 27 21 00

Conventional tools

Tachometer CO measuring instrument

- Connect tachometer and CO measuring instrument; for vehicles with transistorized ignition (refer to job no. 781).
- Run engine up to 60–80° C (104–176° F) oil temperature.

- Check whether regulating levers on throttle valve housing and on injection pump are resting against idle speed stop.
- Check idle speed and emission value and adjust as follows, if required:
- Adjust to prescribed speed with the idle speed air screw (arrow).

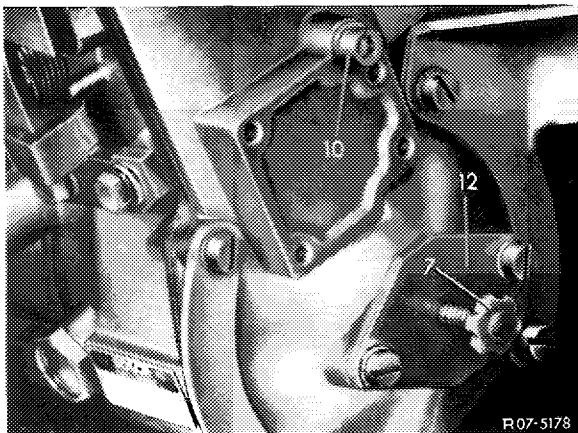
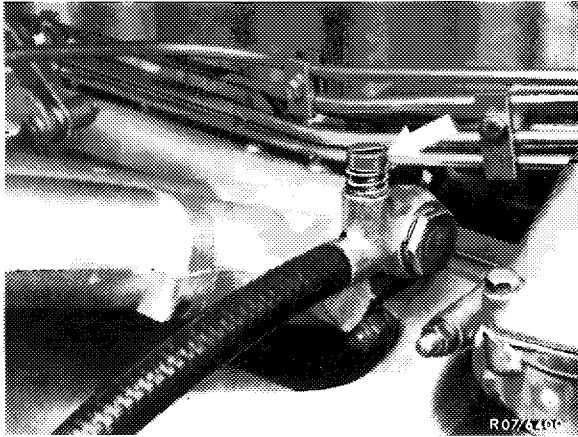

- Adjust to prescribed emission value with the adjusting screw (7) on the injection pump **with the engine switched off**.

Screwing in = richer
Screwing out = leaner

- Accelerate briefly, recheck speed and emission value, if necessary readjust.

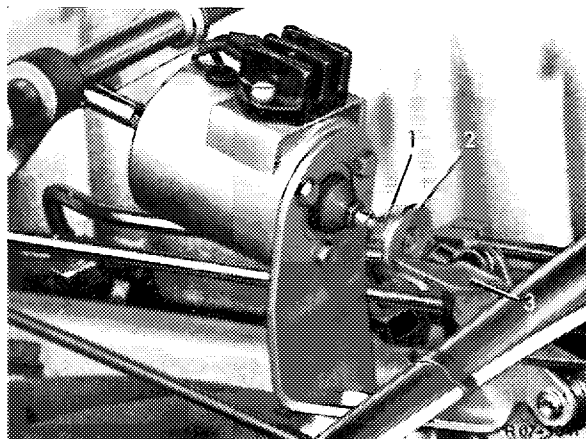

- On engines with solenoid for stabilizing speed, set adjusting nut (2) of solenoid with driving position engaged or air-conditioning switched-on in such a manner that engine is still perfectly running.

Adjust control linkage

- In vehicles with **manual transmission** adjust regulator rod (3) in such a way that the roller (4) in the slotted lever (5) has contact with the end stop free of tension.

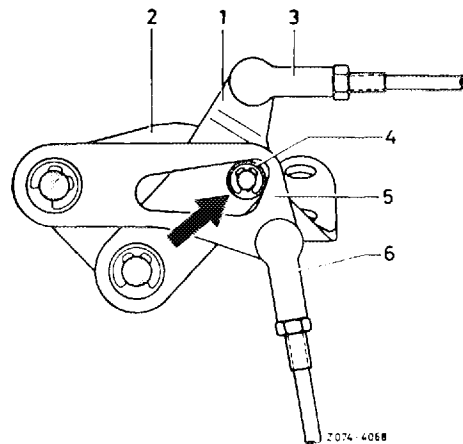

- In vehicles with **automatic transmission** disconnect regulator rod (15) and connect free of tension in fully extended position.

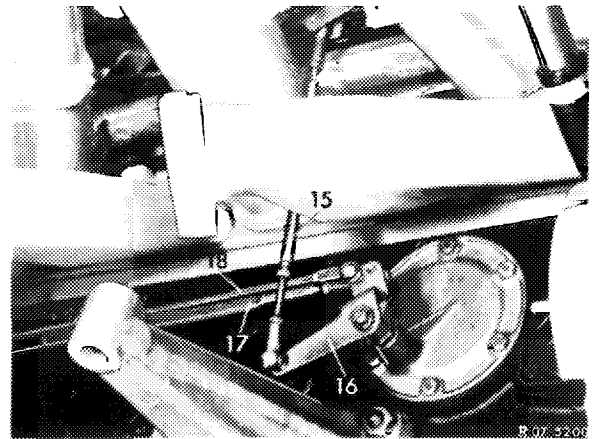

- Place selector lever in drive position, (automatic transmission) switch on air conditioner and turn power steering to full lock; the engine must continue to run. Adjust engine speed, if necessary.

Check and adjust idle speed and idle CO

Engine 110
with Solex Carburetor 4 A 1

Test values

Adjust engines according to data on pertinent emission reference plate.

Model year	Idle speed 1/min	Emission values at Idle % CO	
1973	750–950	up to 1.5	
1974 Federal Emission Control (black reference plate)			
1974 California Emission Control (green reference plate)	700–900	with air injection max. 1.5	without air injection 6–8
1975/76	800–900	---	max. 1.0

Vacuum governor adjusting values¹⁾

Model year	Engine speed 1/min vacuum hose pulled-off	Engine speed 1/min driving position engaged
1973/74	1.200–1.400	600–700
1975/76	1.700–1.900	

¹⁾ Engine should still run perfectly when all supplementary units are added.

Special tool

Oil tele-thermometer



116 589 27 21 00

Conventional tools

Speedometer, CO measuring instrument

