

All models

Retighten bolts on slip joints or flanged connections. Torque to 20 Nm.

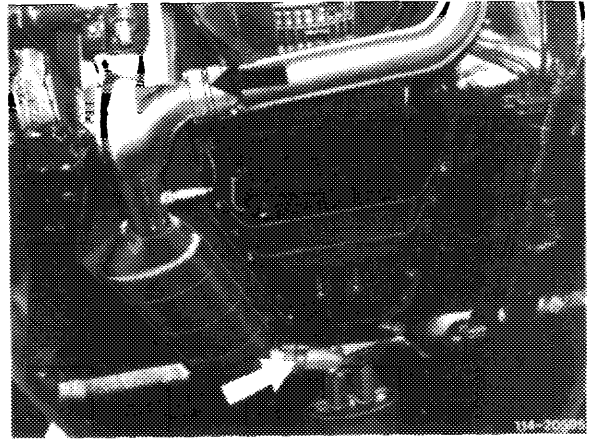

Model 107.025/045; 107.048 similar (no rear flange)

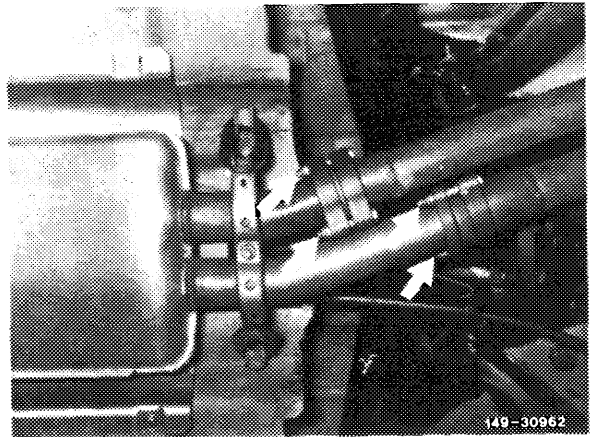

Model 107.048

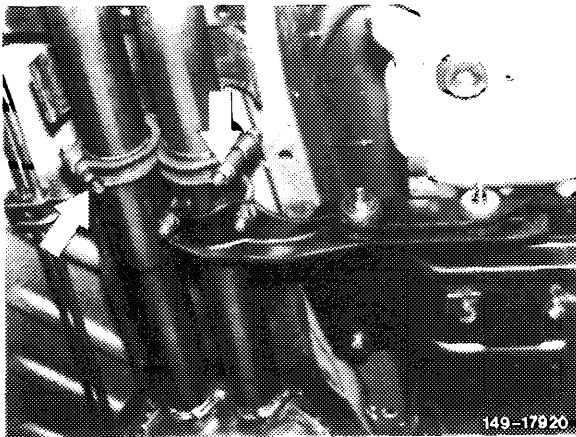

Model 123.03/05

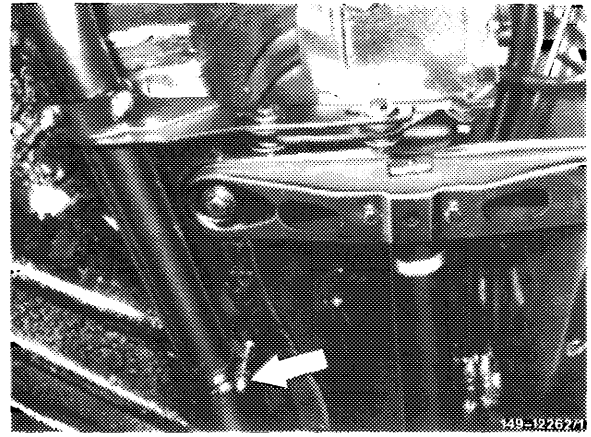

Model 123.123/130/150/190

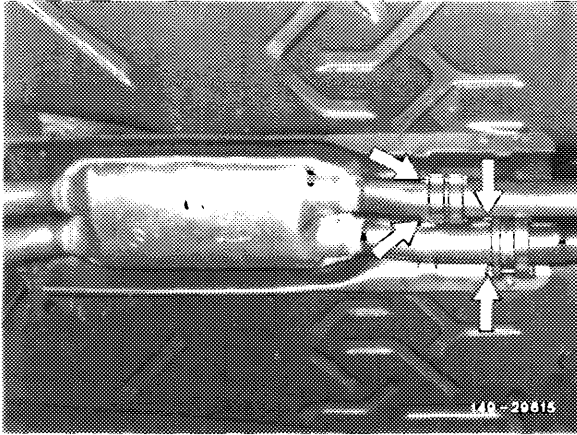

Model 124.026/030/05/09/2, 126.02, 201.029/034

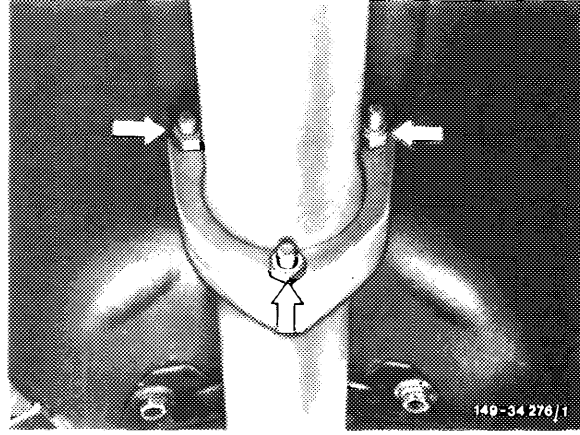

Model 124.133/193, 126.1, 201.128

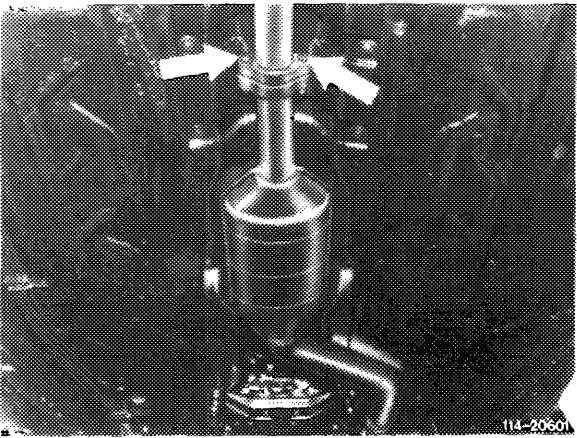

Model 126.03/04 up through 09.1985

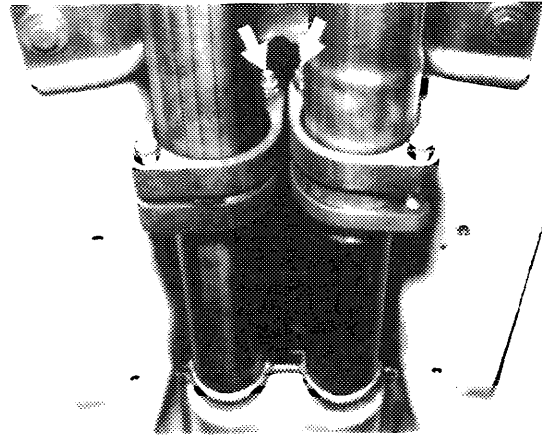

Model 126.03/04 as of 09.1985

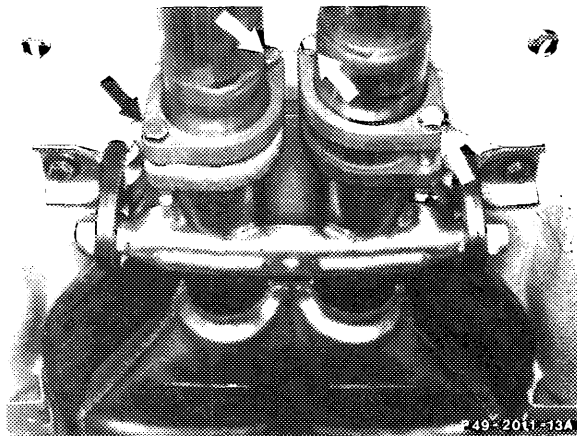

Model 129

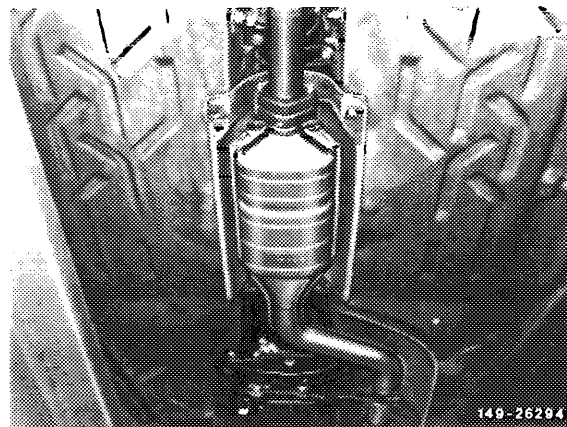

Model 201.024/028

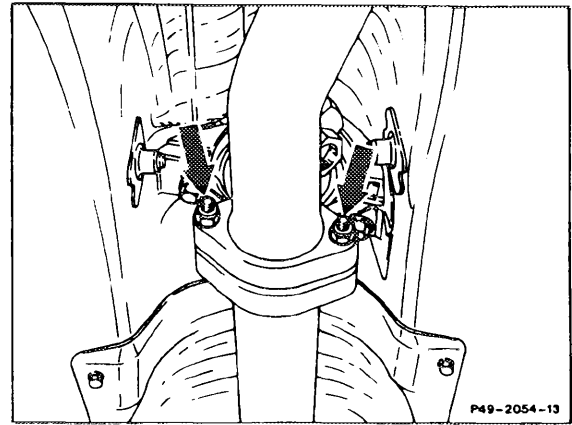

Model 201.122/126

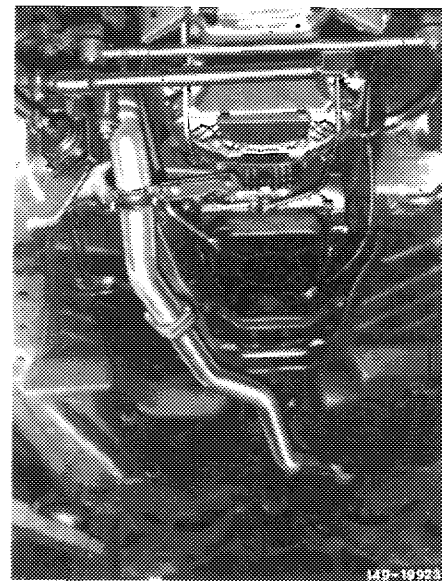

Model 123.133/153/193

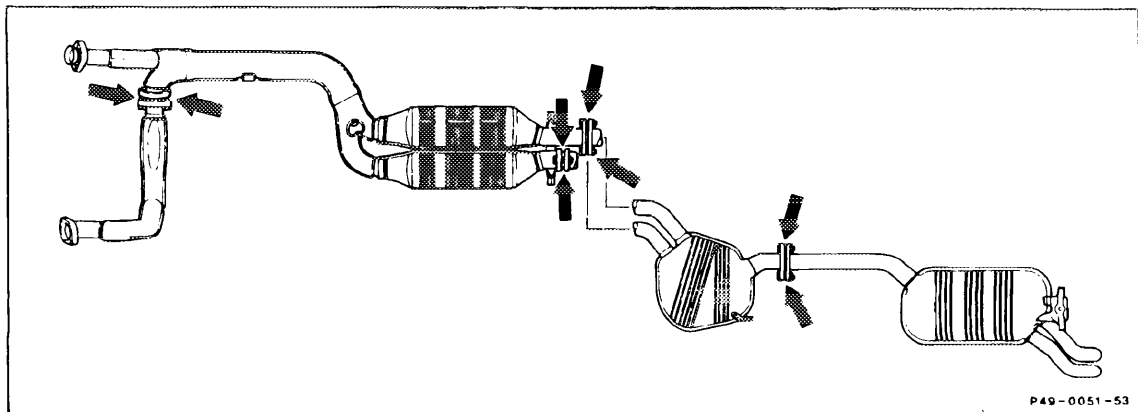

Model 124.034/036

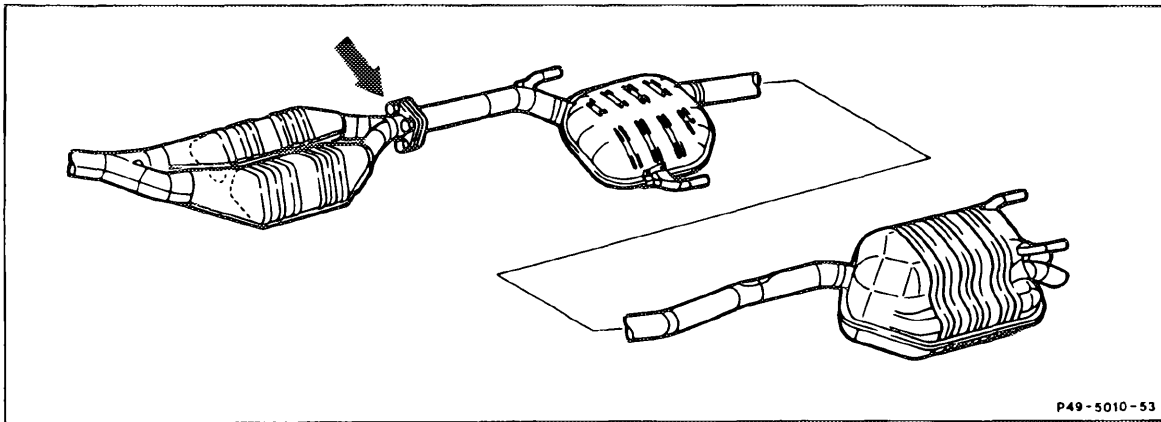

P49-5010-53

Model 140.03

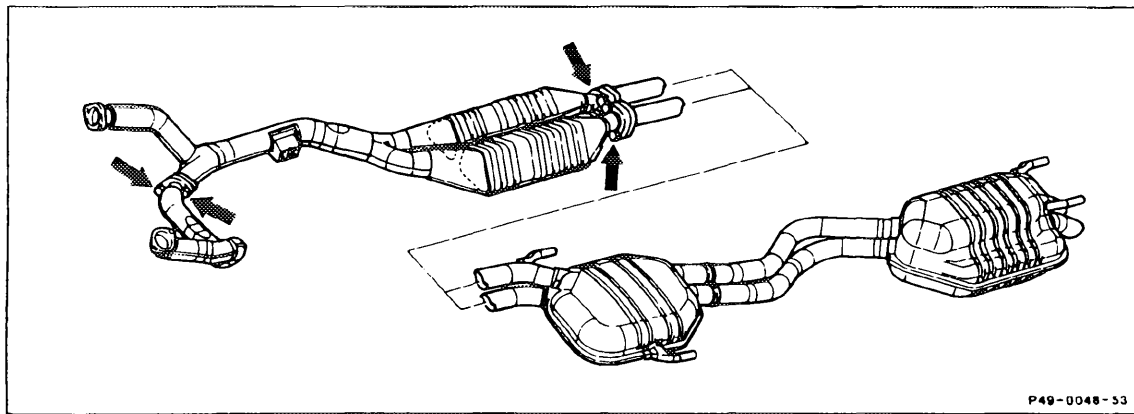

P49-0048-53

Model 140.042/051

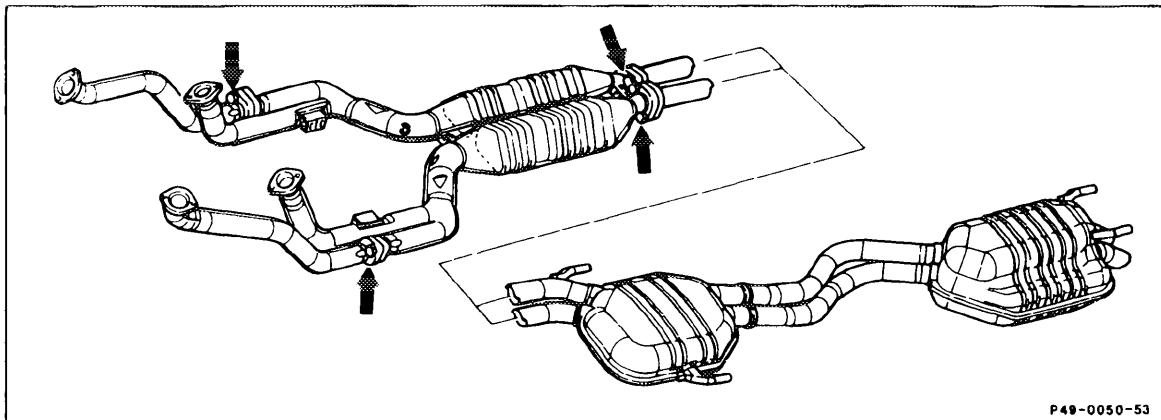

P49-0050-53

Model 140.057